

Linieblok  
FC Fa

FC Fa

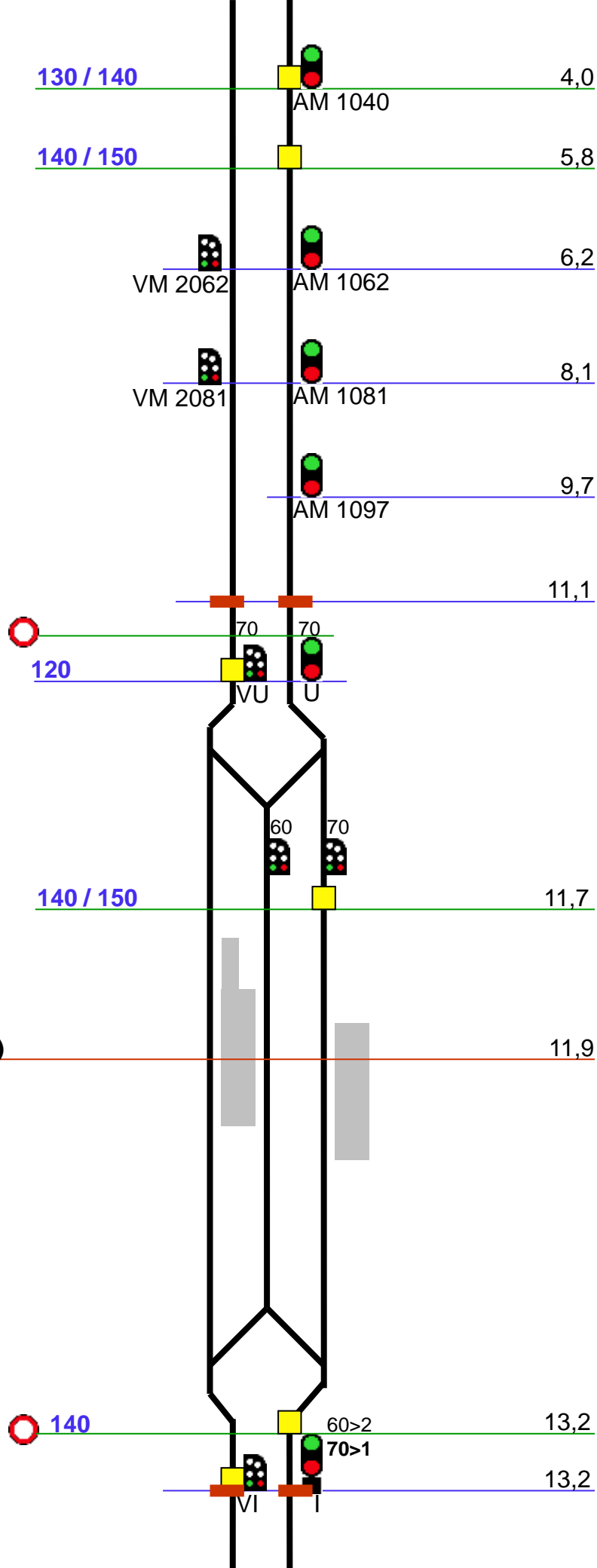

Breining (Bet)

14,8

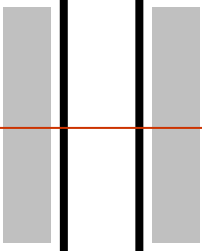

AM 1150

15,0

140 / 150



15,3

140



16,0



AM 1178

17,8



AM 1202

20,2



AM 1227

22,7

Linieblok  
FC Fa



24,5



70

70

120



VU



U

24,6

140 / 150

Industri

70

40

40

**Vejle (Vj)**  
Overgangsstation  
FC Fa  
ID 67700

25,7  
114,2

6 5 4 3 2

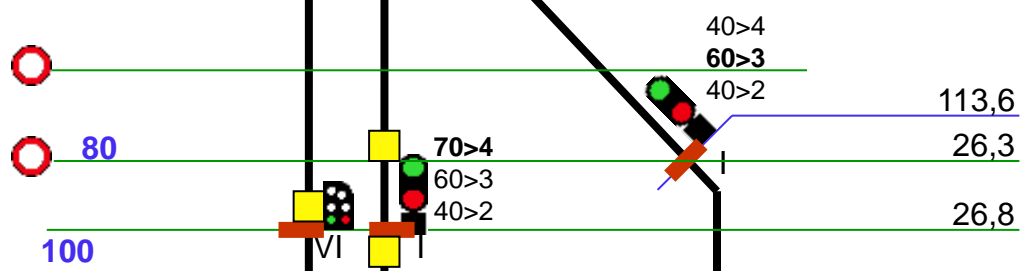

**Vejle Sygehus (Vjs)**

28,2  
113,2

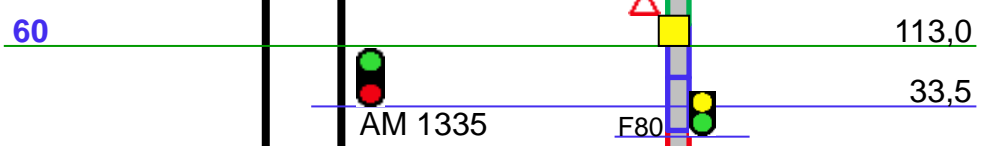

Aarhus str 23

Linieblok  
FC Hr

FC Hr

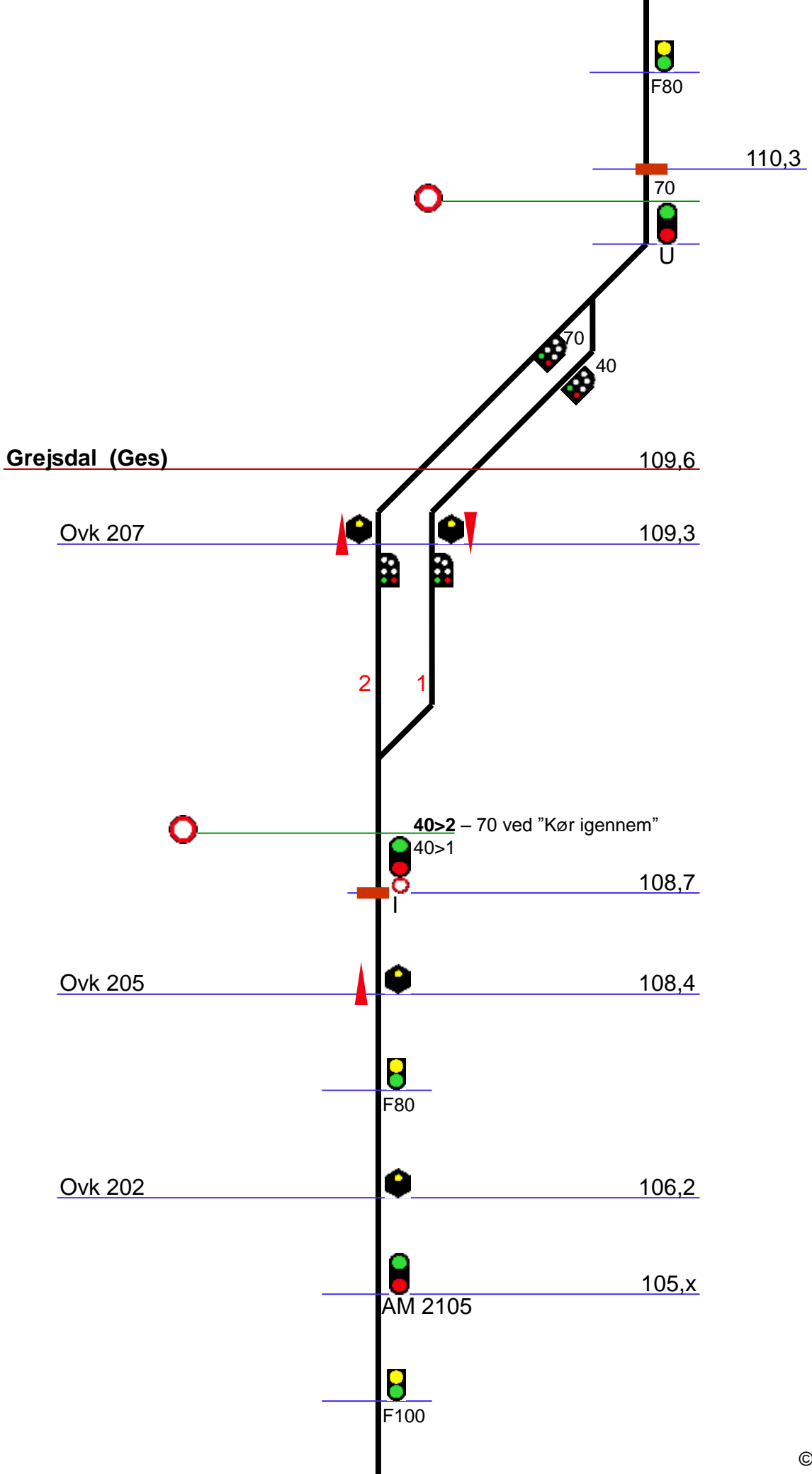

Linieblok  
FC Hr

FC Hr

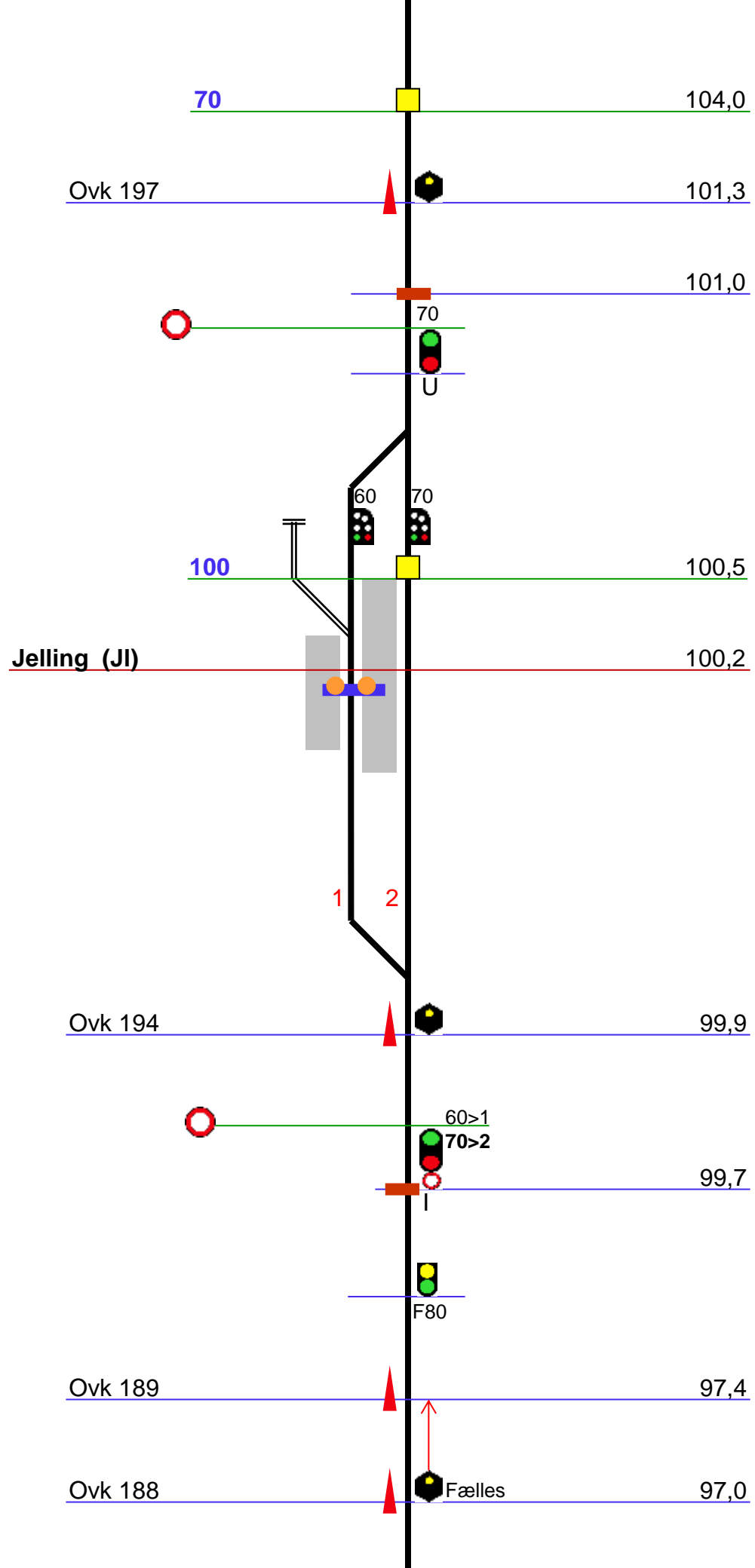

Linieblok  
FC Hr

FC Hr

Linieblok  
FC Hr

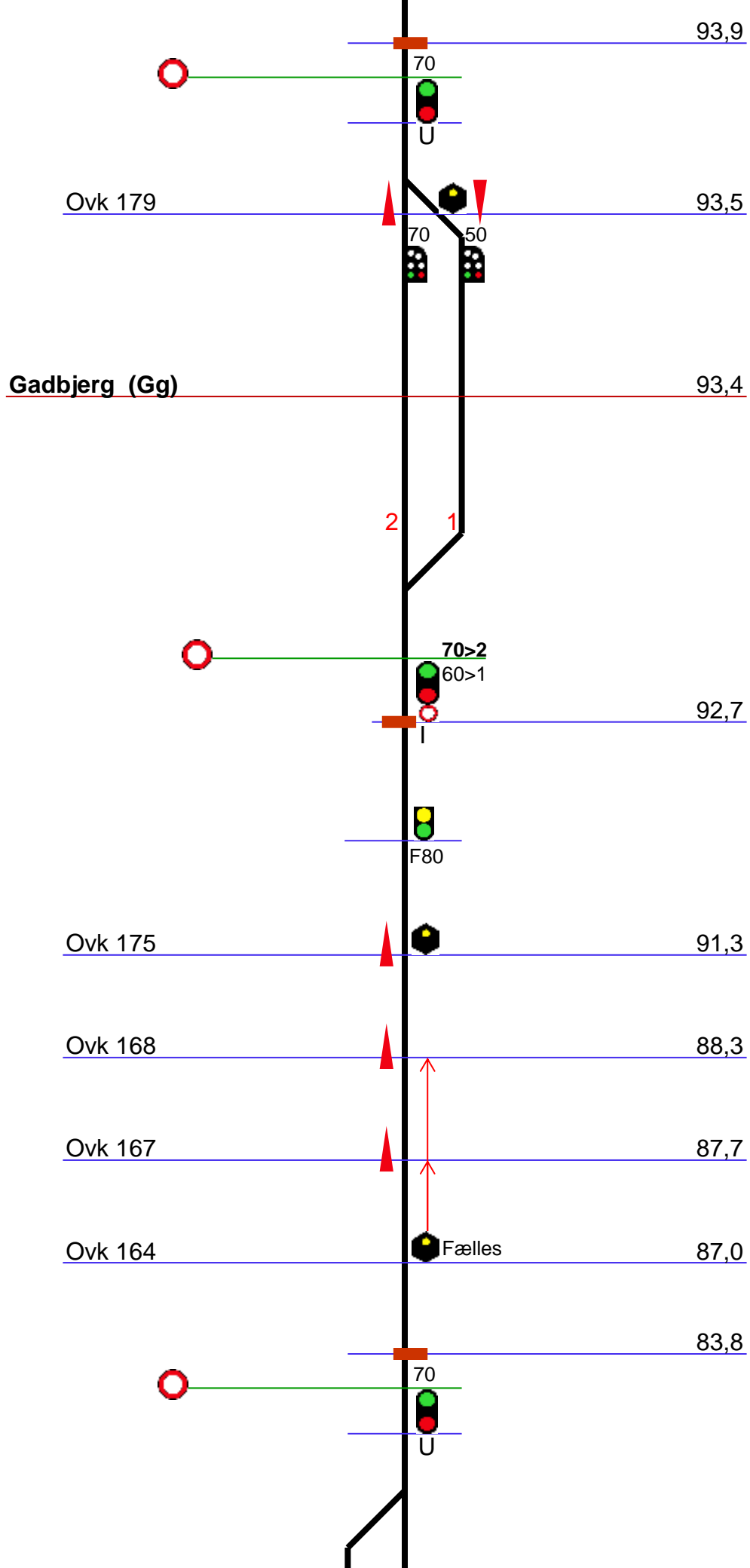



FC Hr

**Give (Gw)**

82,8

1

2



60>1  
70>2

82,2

Ovk 154

81,7

110

81,5

F80

Ovk 151

78,0

Linieblok  
FC Hr

75,7

70

U



60

70

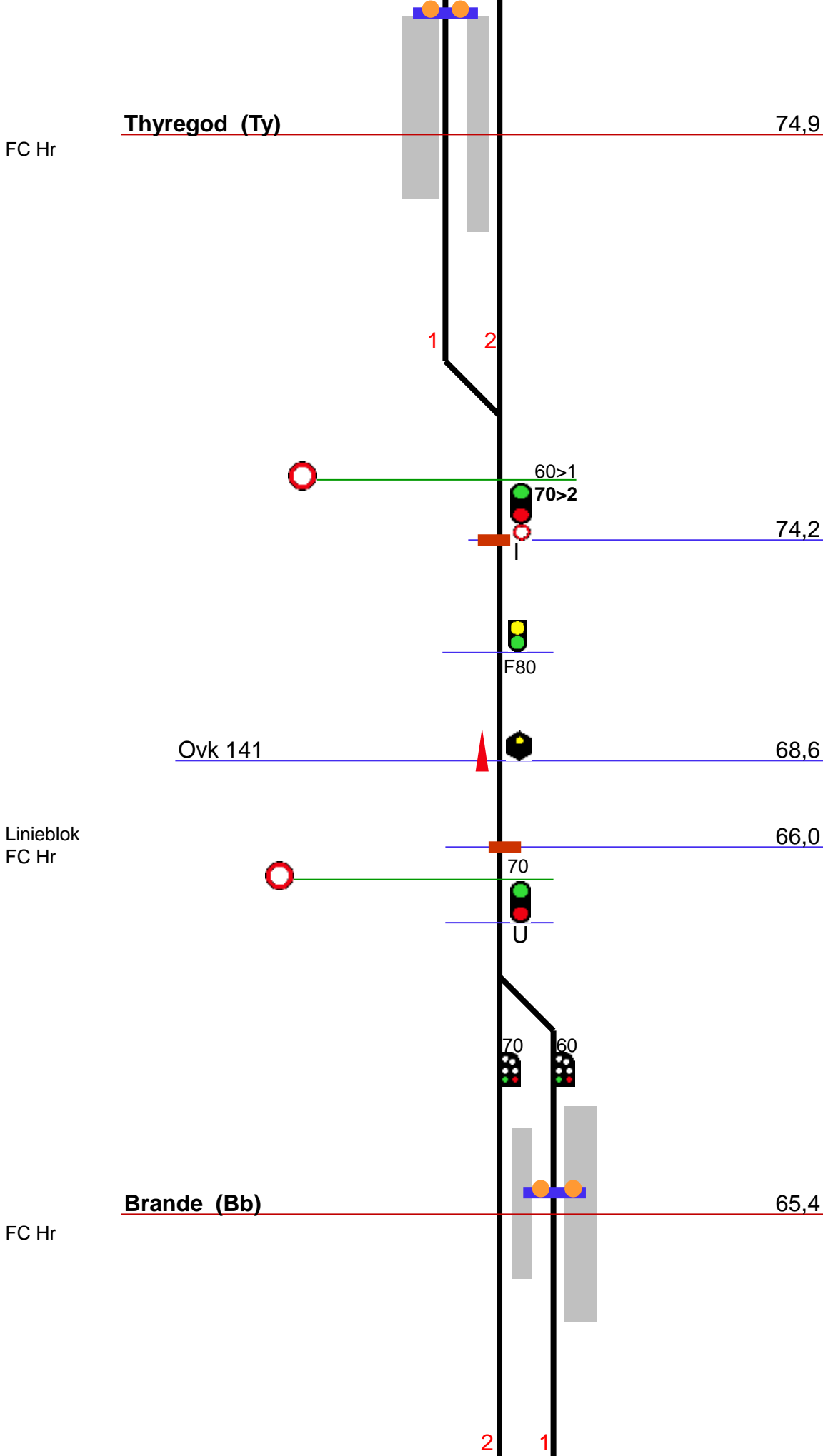

FC Hr

**Thyregod (Ty)**

74,9

1 2



60>1  
70>2

74,2



F80

Ovk 141



68,6

Linieblok  
FC Hr



70



U

66,0



**Brande (Bb)**

65,4

FC Hr

2 1

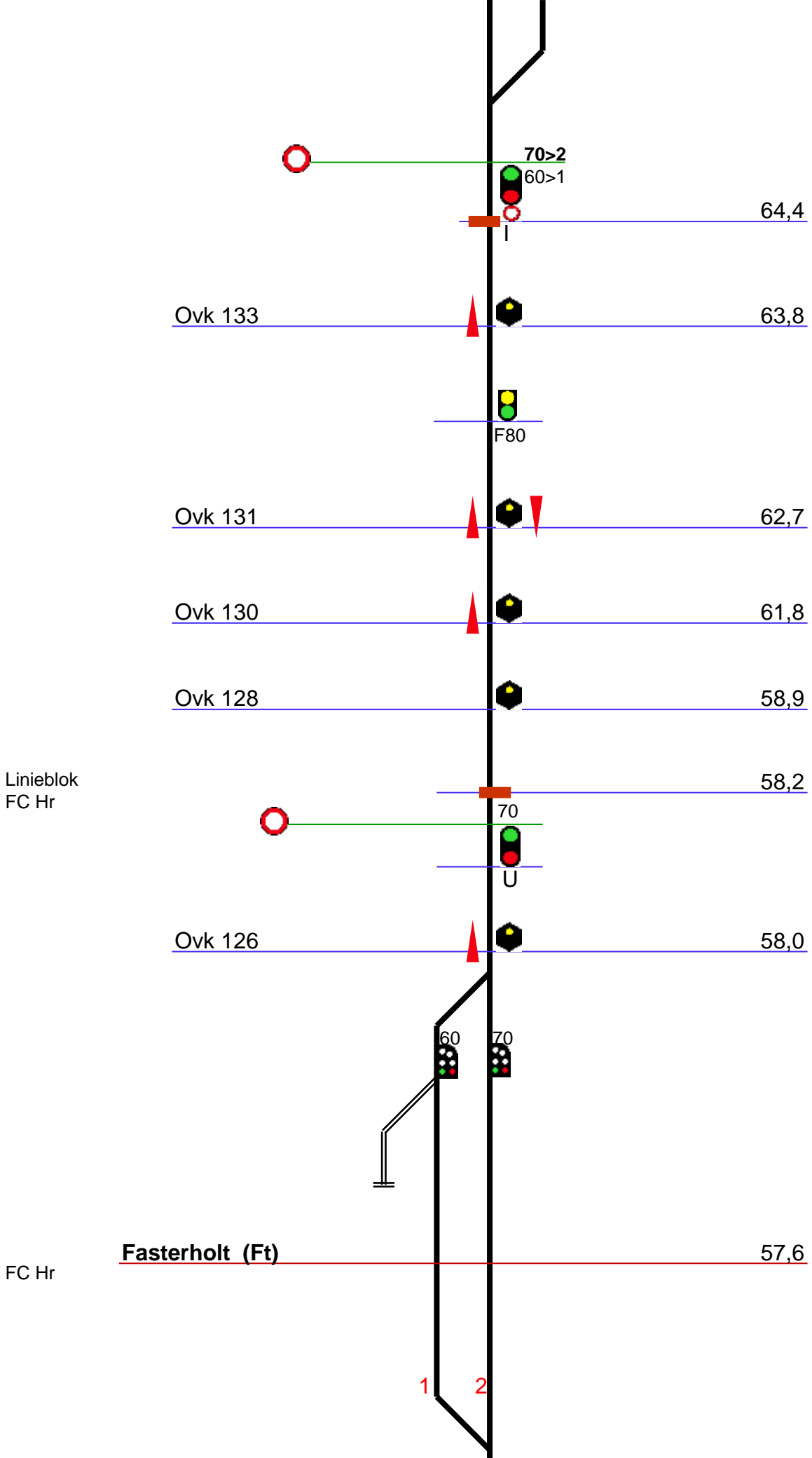

Linieblok  
FC Hr

FC Hr

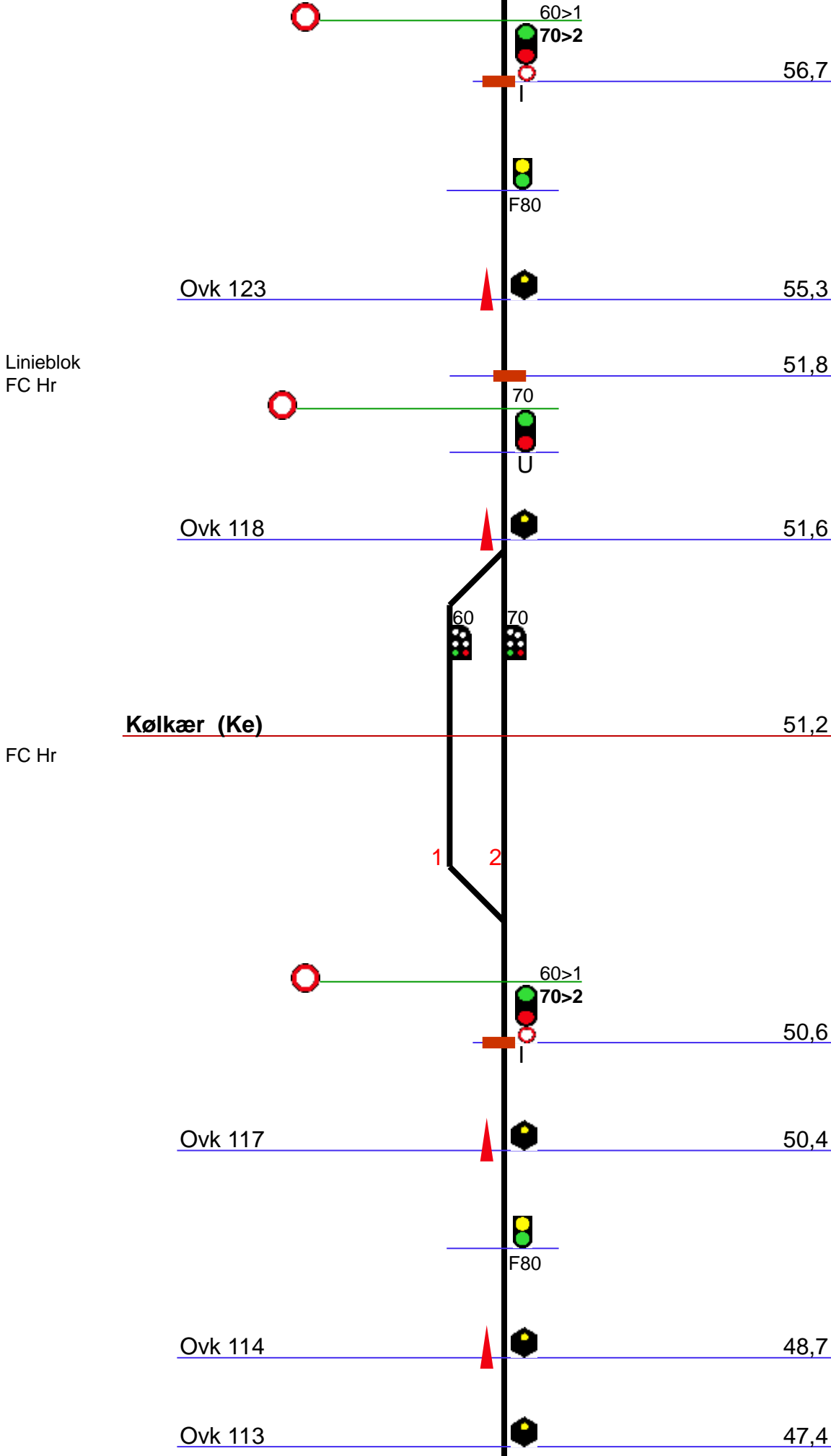

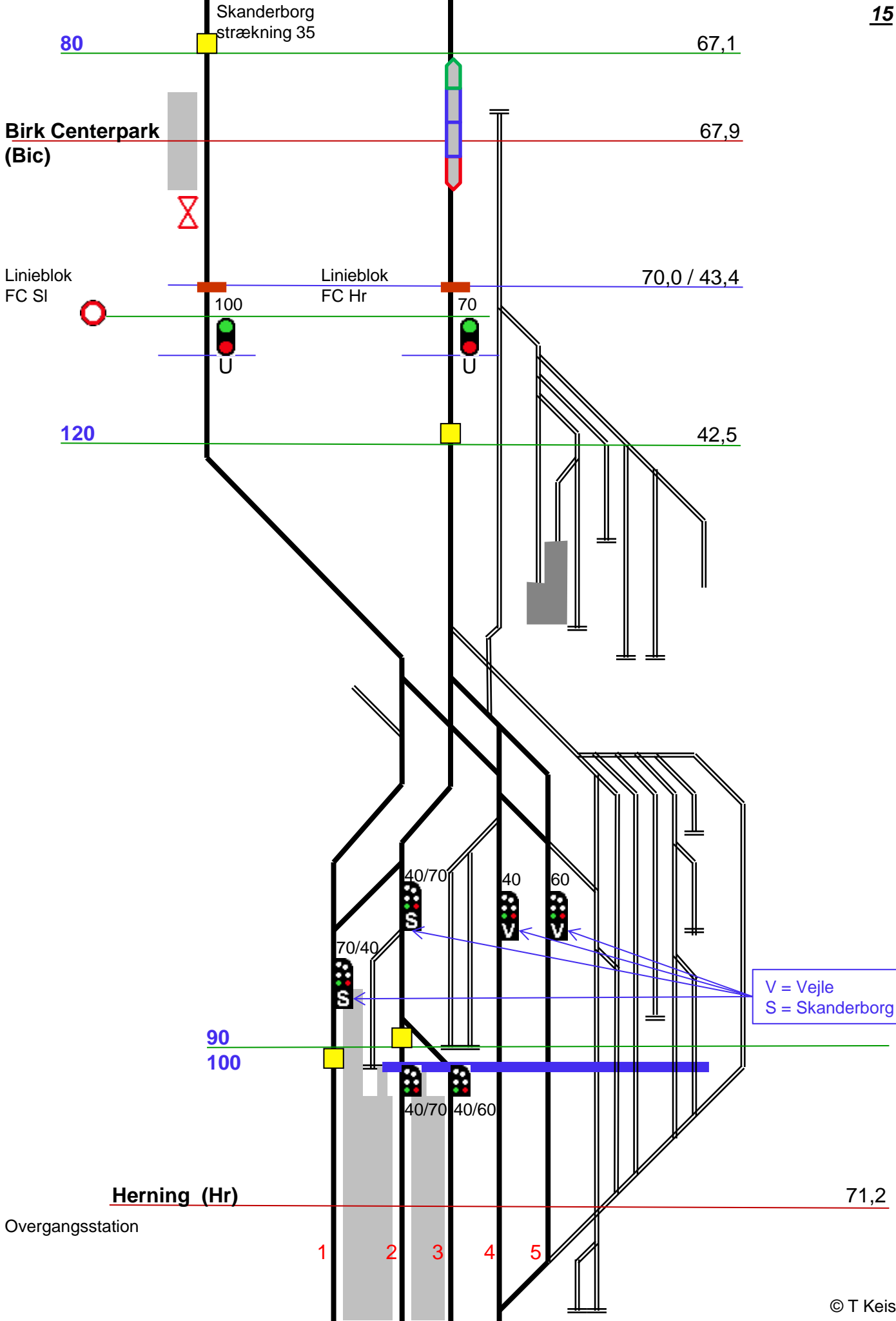

V = Veje  
S = Skanderborg

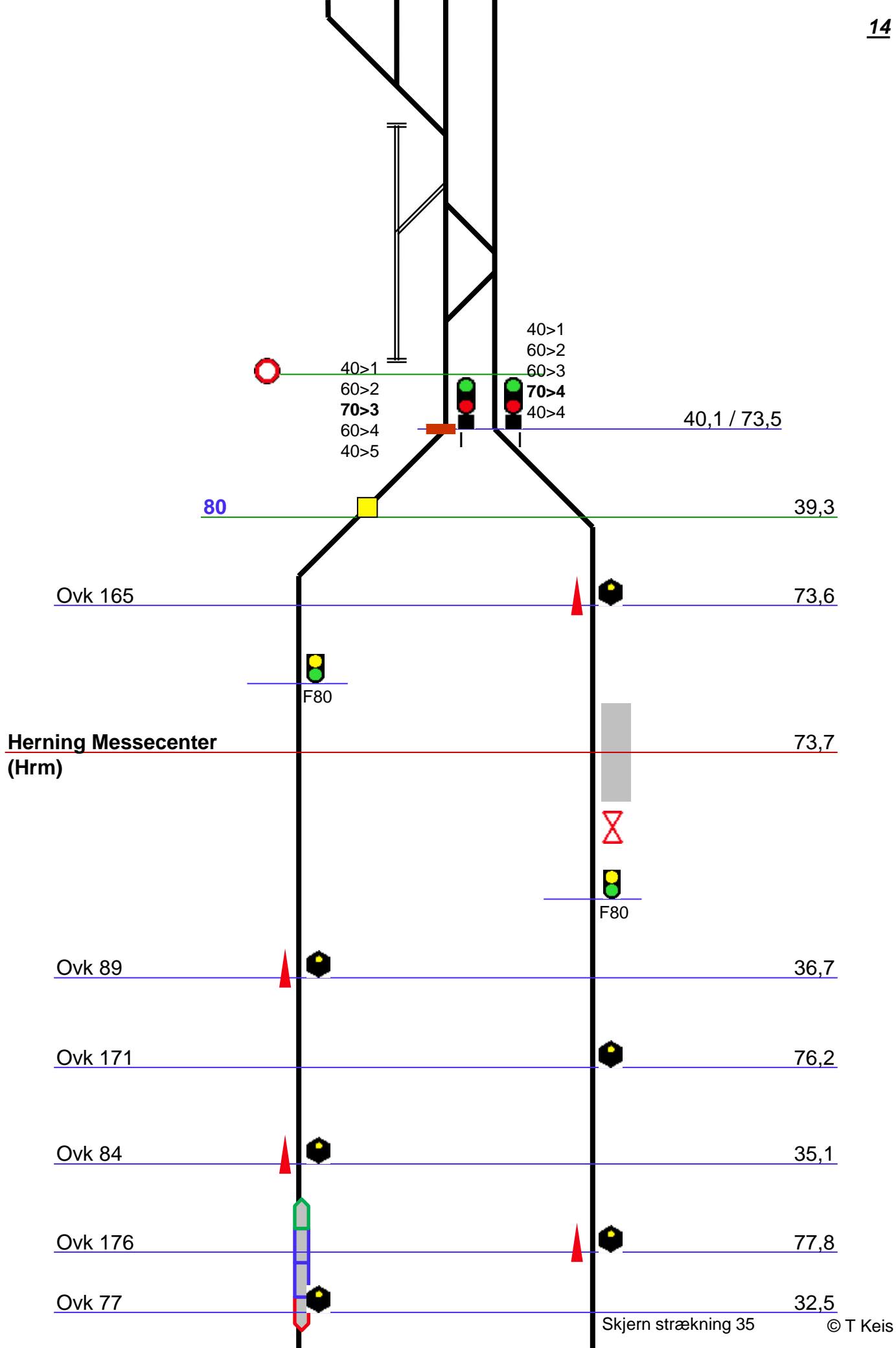

Linieblok  
FC Hr

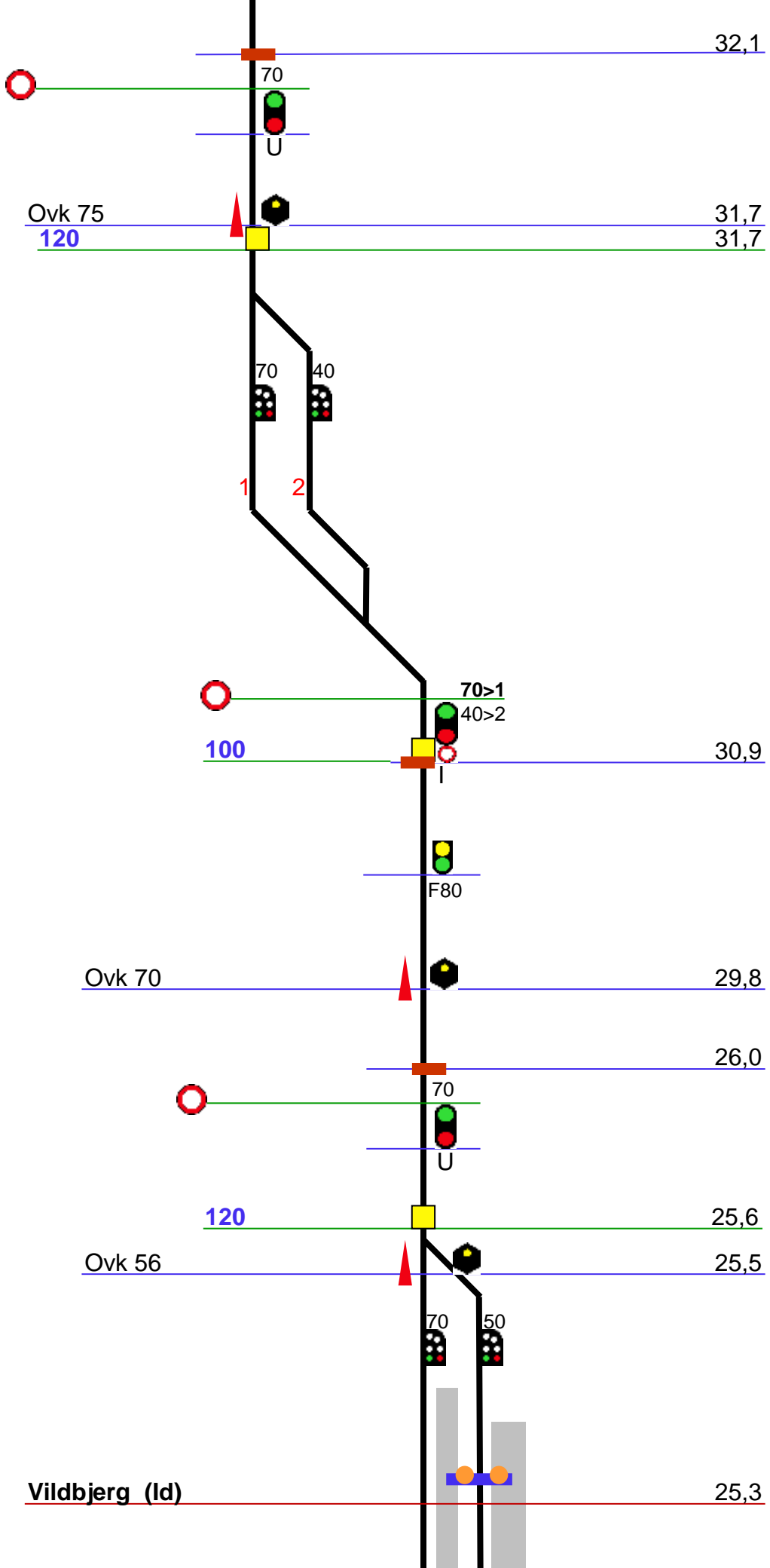

Ovk 75  
120

32,1  
31,7  
31,7

70>1  
40>2  
100

30,9

Ovk 70

29,8

Linieblok  
FC Hr

26,0

120

25,6

Ovk 56

25,5

Vildbjerg (ld)

25,3

FC Hr

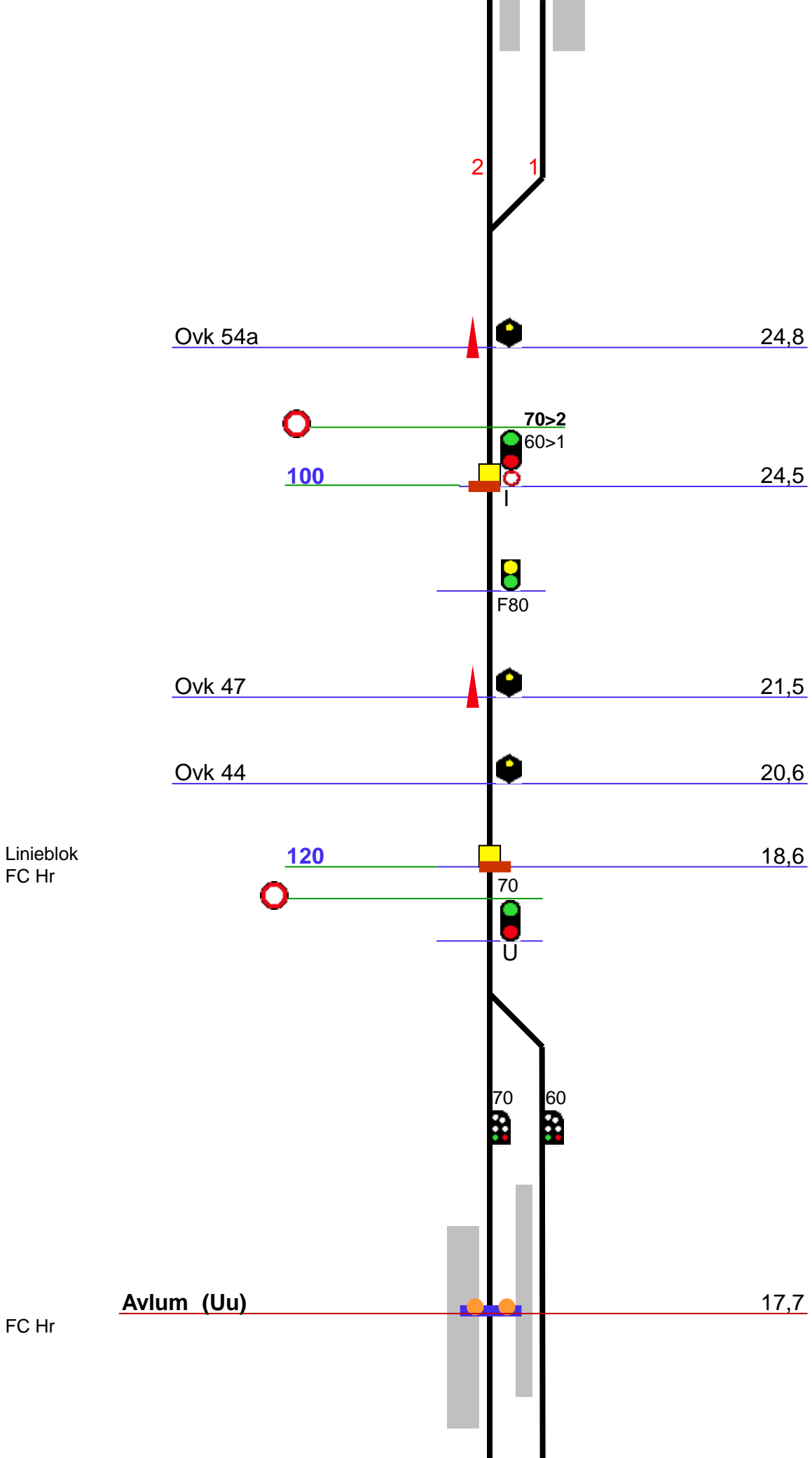

Linieblok  
FC Hr

FC Hr



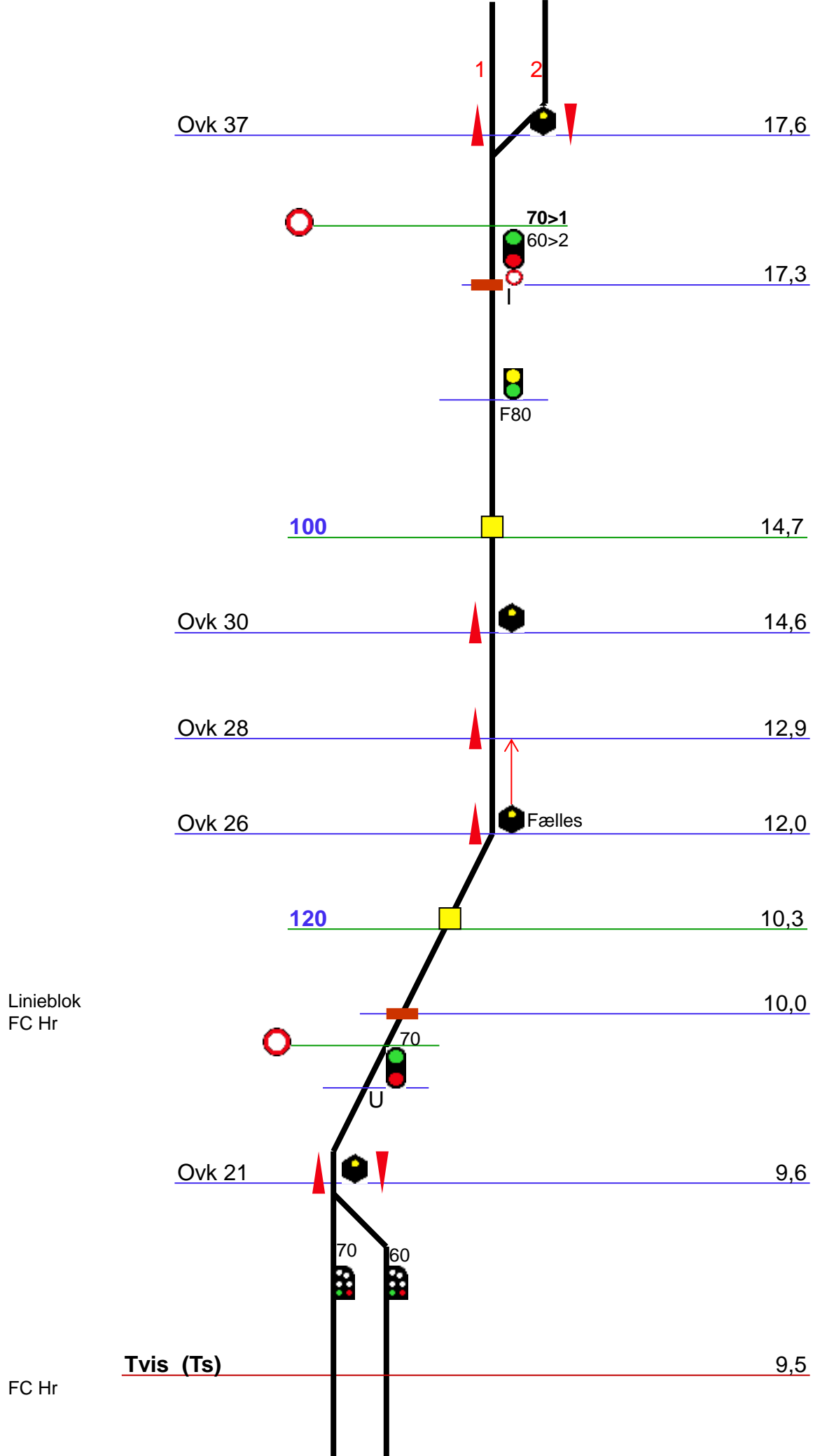

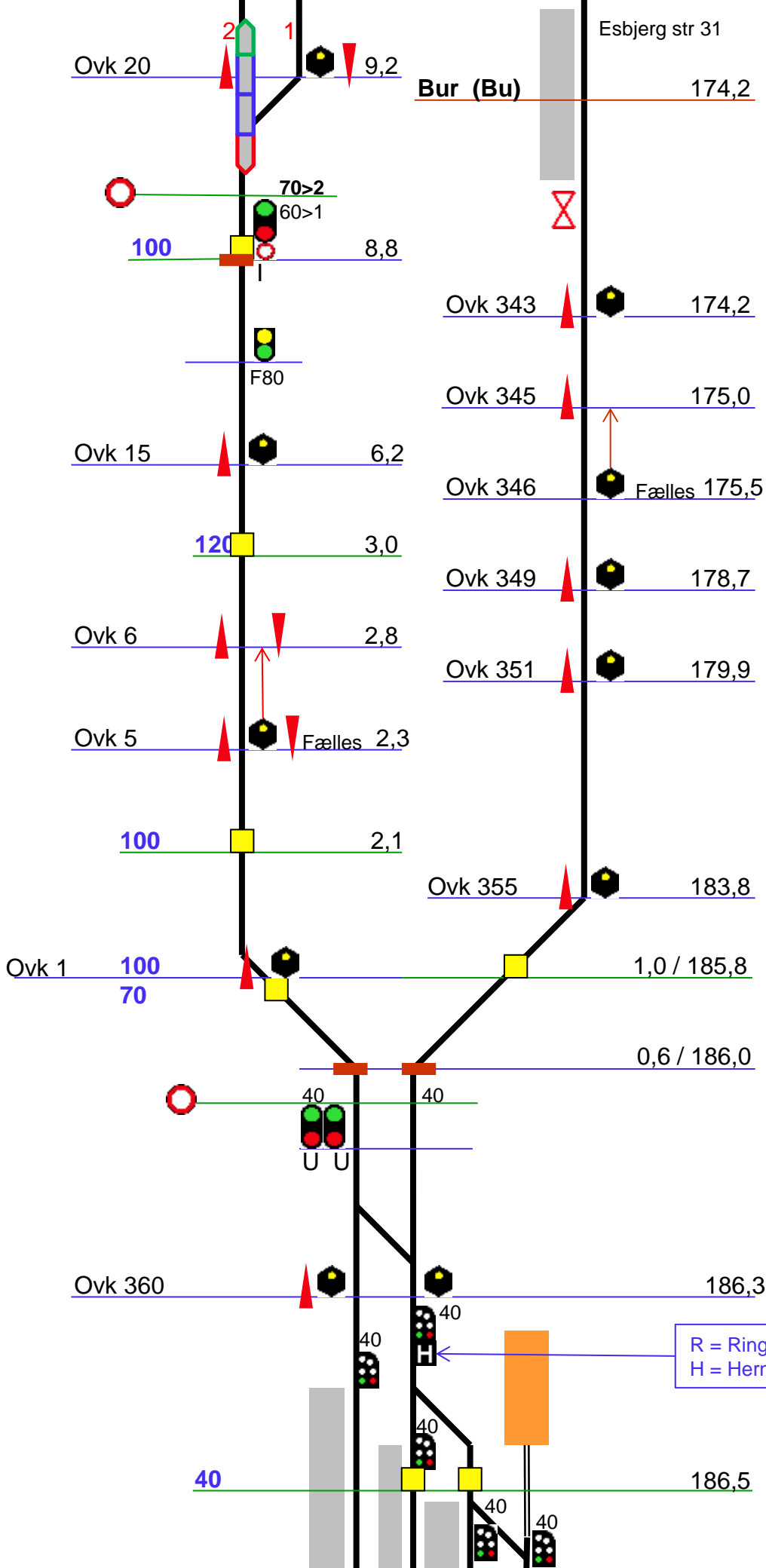

Linieblok  
FC Hr

R = Ringkøbing  
H = Herning

**Holstebro (Ho)**

Overgangsstation  
FC Hr  
ID 67200

186,6

1 2 3 4 5

Ovk 361

187,1

60>1  
40>2  
70>3

187,5

F80

194,5

Linieblok  
FC Ar

70  
U

120

Ovk 377

195,1

195,1

70 60

**Hjerm (Hm)**

195,1

FC Ar

1 2

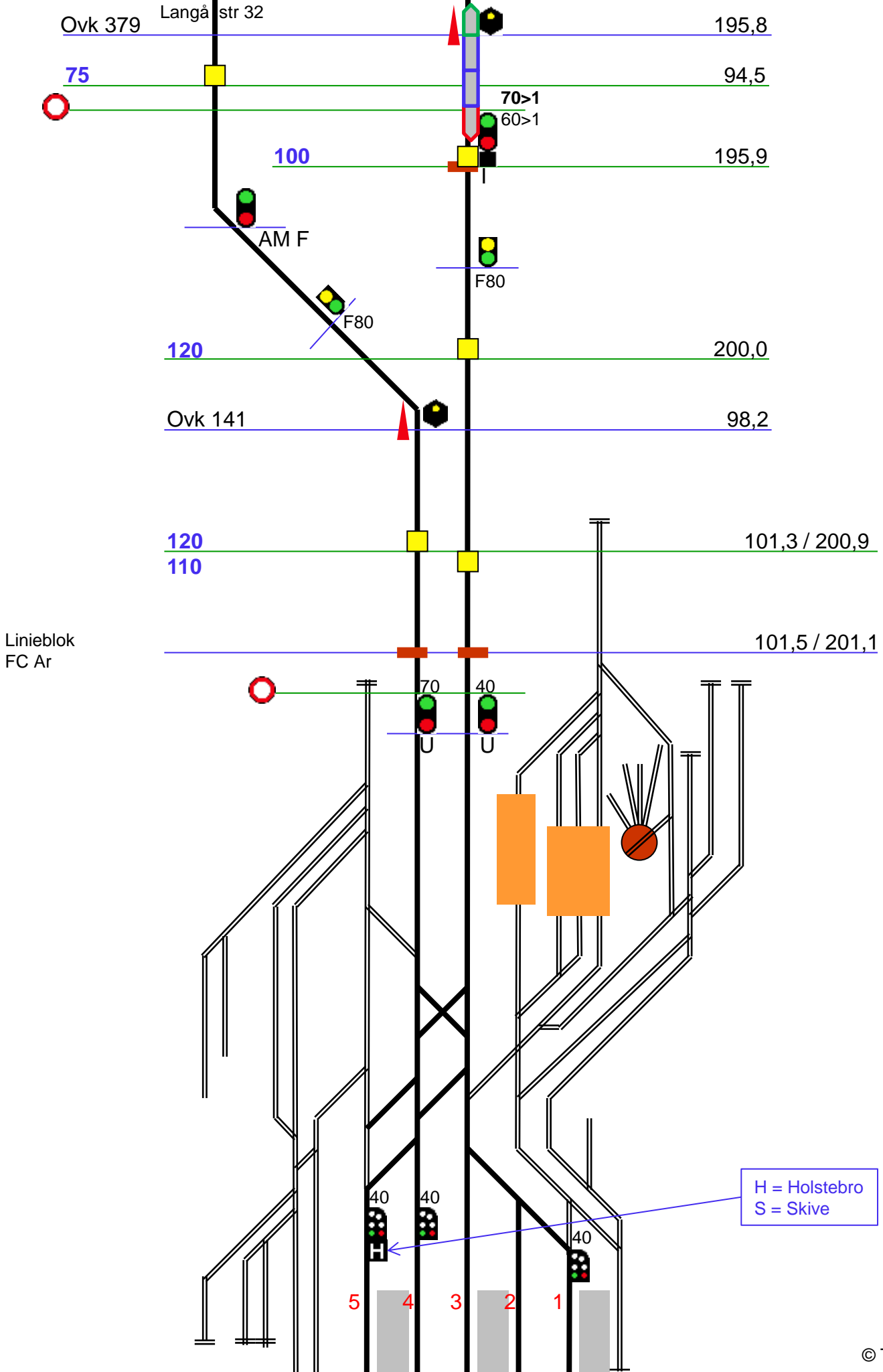

H = Holstebro  
S = Skive

**Struer (Str)**

Overgangsstation  
ID64700

202,1 / 0,0

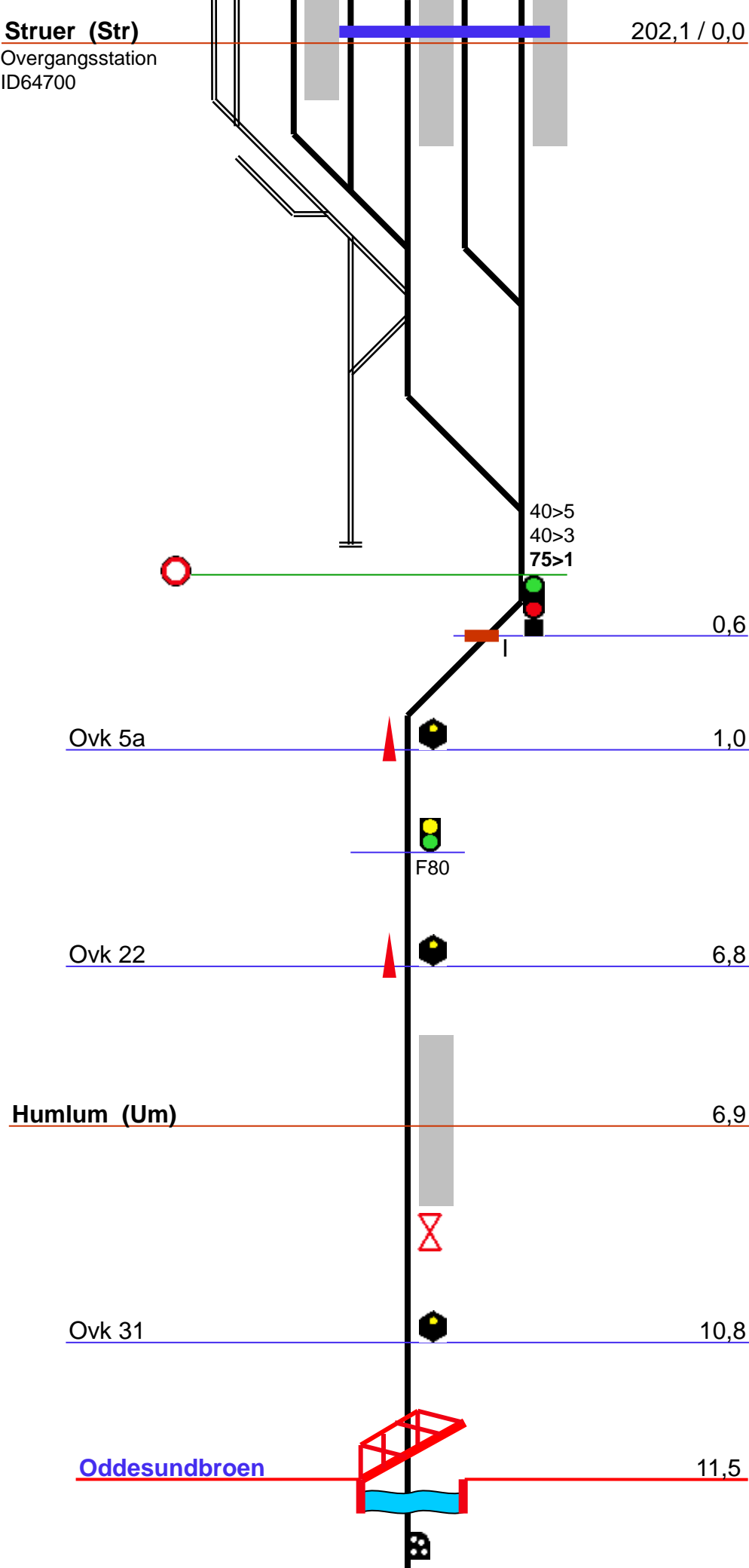

40>5  
40>3  
75>1

**Oddesund Nord (No)**

12,4



Ovk 2

12,6



F80

Ovk 10

15,8

Ovk 11

16,1

Ovk 12



Fælles

16,3

**Uglev (UI)**

16,8

Ovk 14

16,8

Ovk 35a

21,2

Radiodirigeret  
FC Ar



21,3

Ovk 38

21,6

75

50

21,7

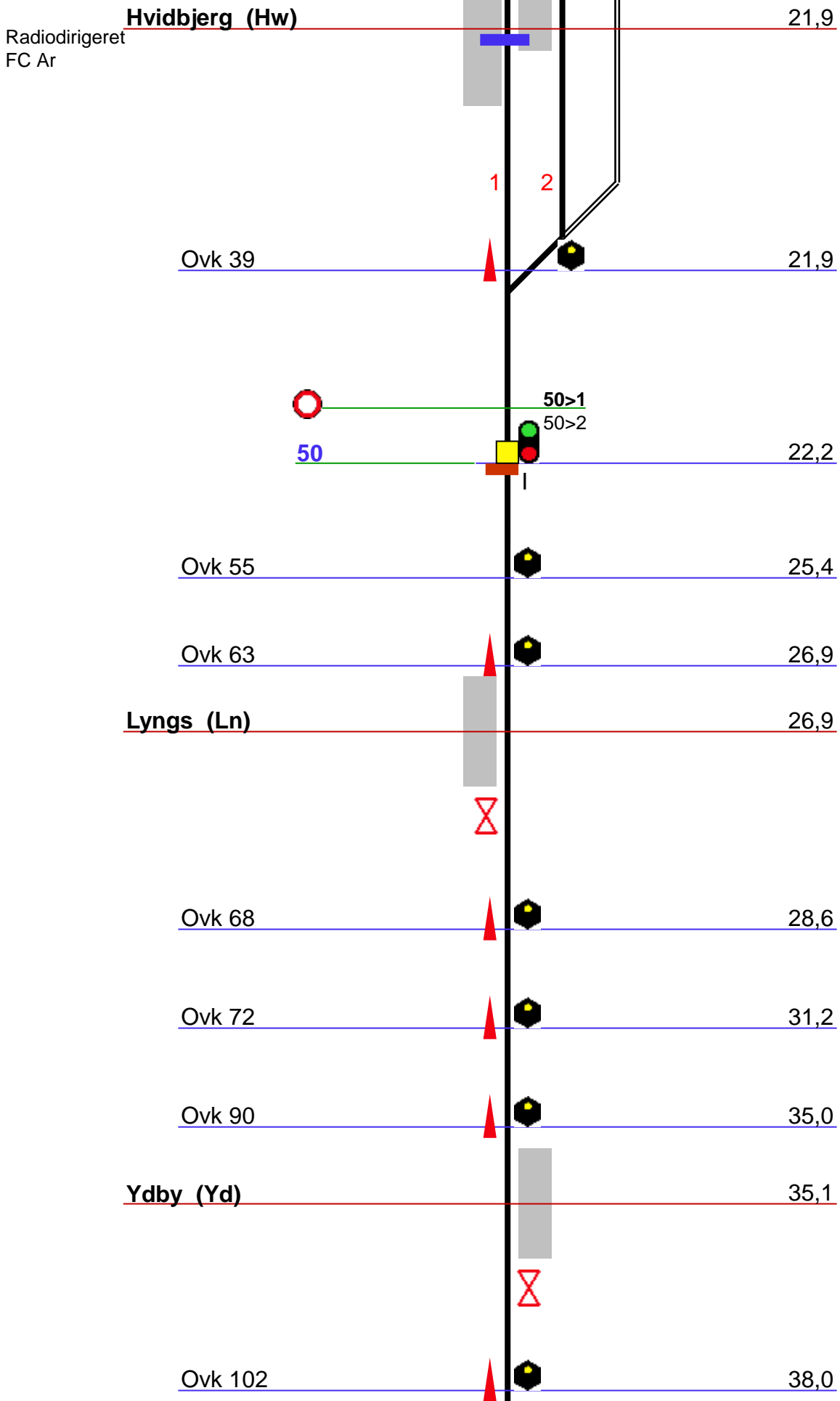

Radiodirigeret  
FC Ar

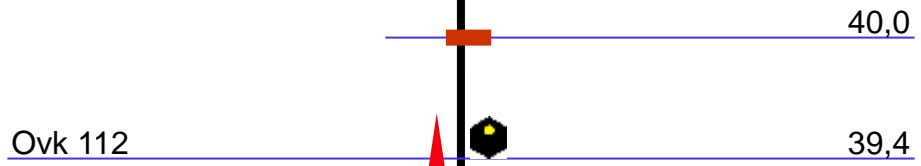

**Hurup Thy (Ur)**

Radiodirigeret  
FC Ar

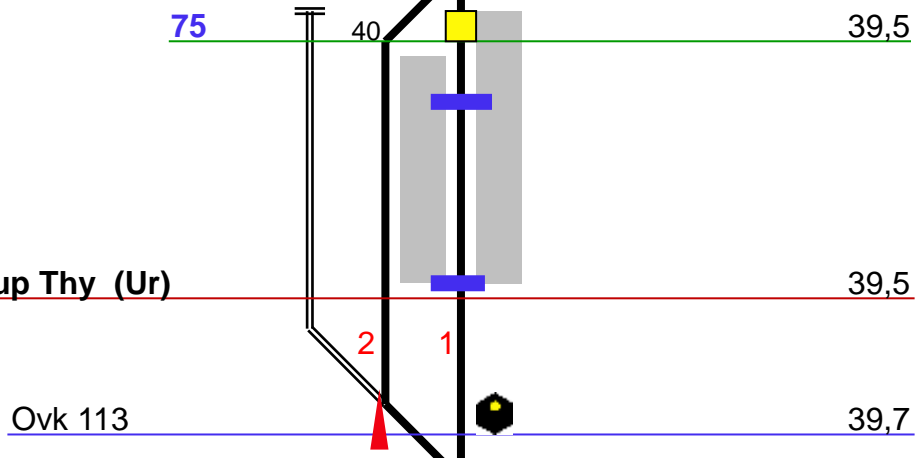

Radiodirigeret  
FC Ar

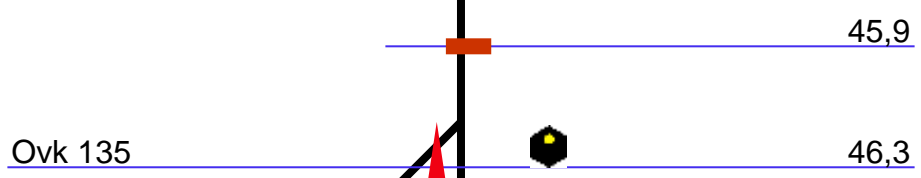

Radiodirigeret  
FC Ar

2 1



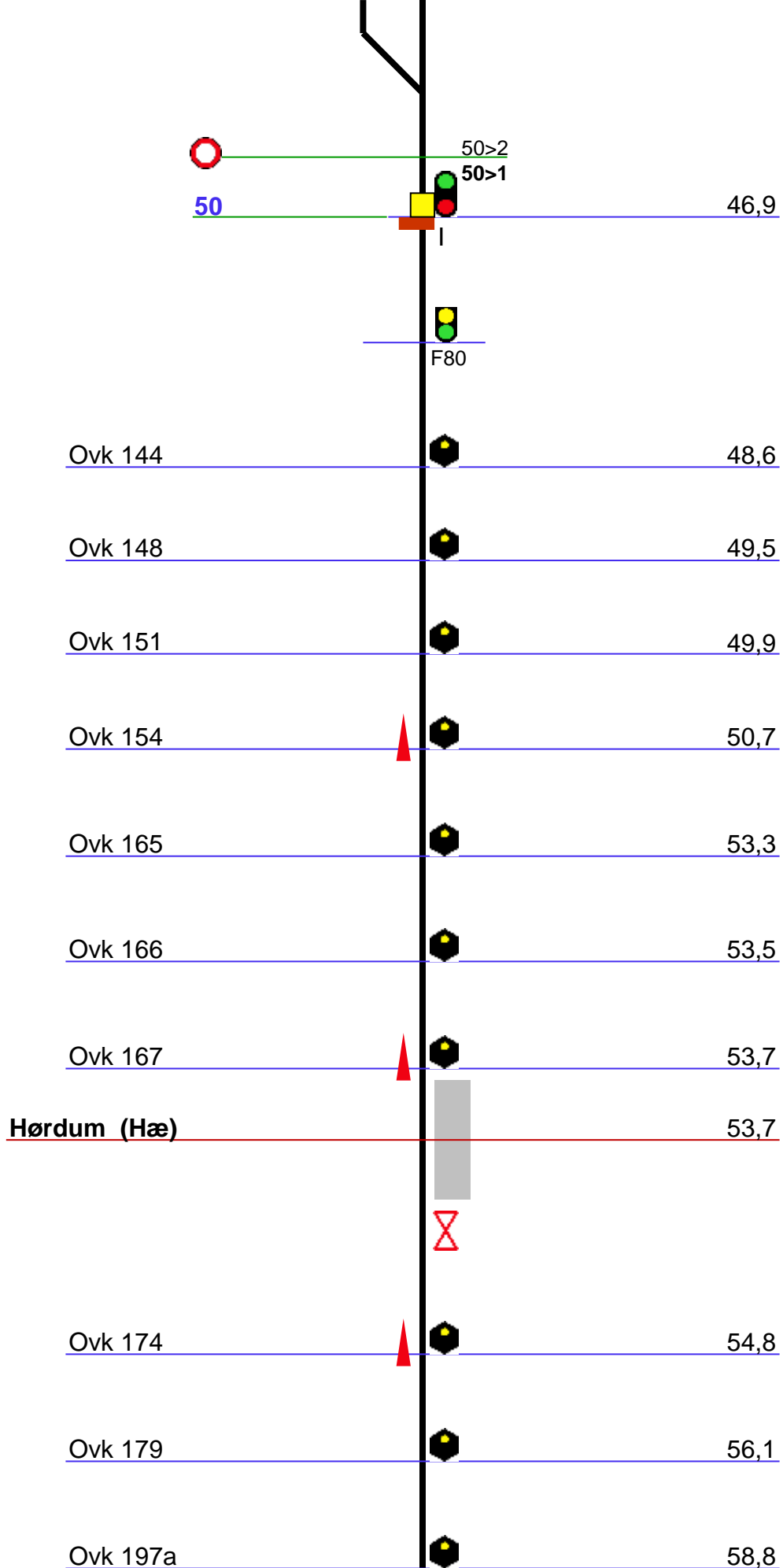

Radiodirigeret  
FC Ar

58,8

75

50



59,1

**Snedsted (Sne)**

59,2

Radiodirigeret  
FC Ar



Ovk 199



2

1



59,3



50

50>2

50>1



I

59,7

Ovk 201



59,8

Ovk 207



61,4

Ovk 214



62,5

Ovk 215



63,0

Ovk 217



63,4

**Sjørring (Ri)**

67,0



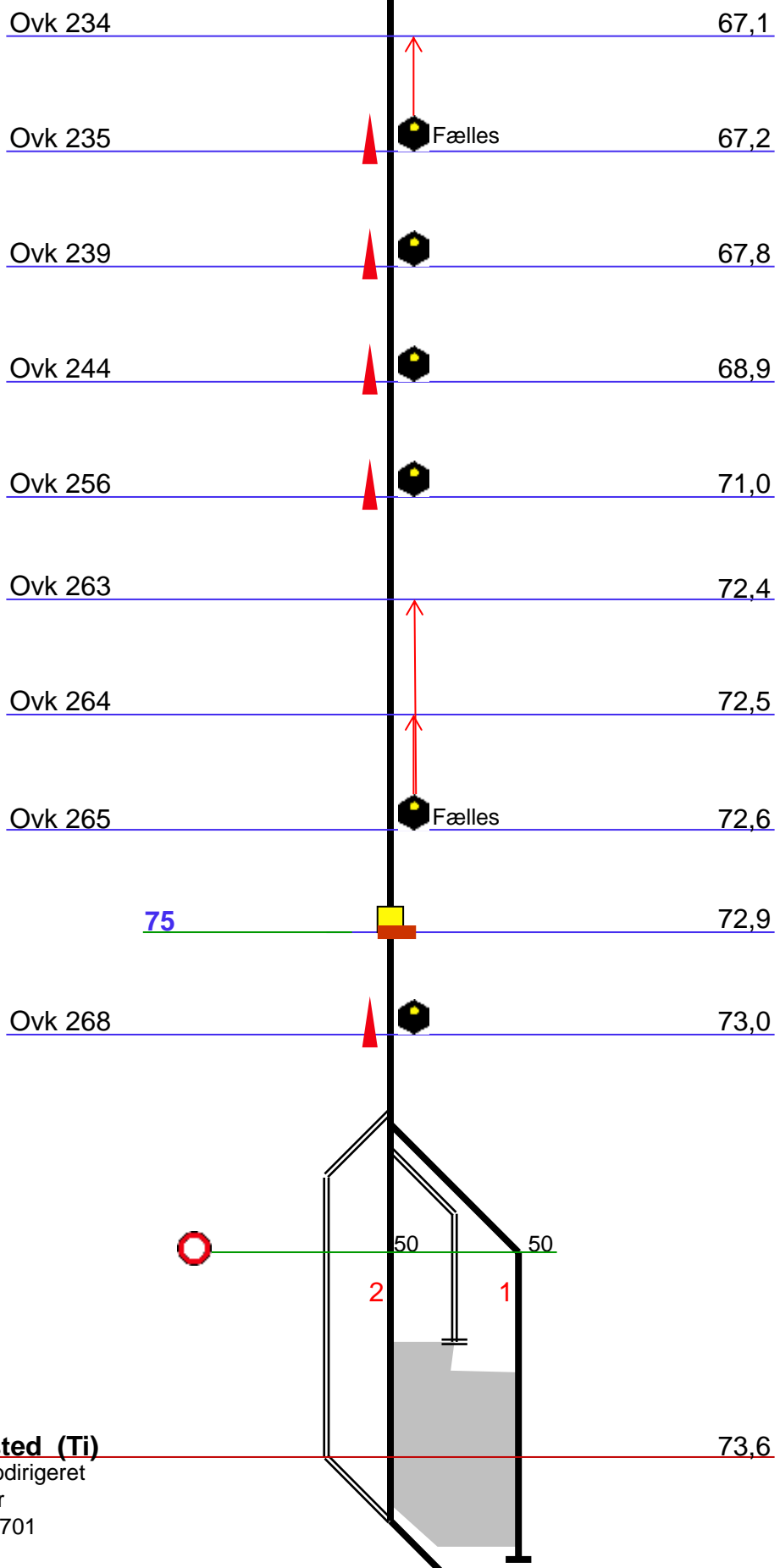

Radiodirigeret  
FC Ar

**Thisted (Ti)**  
Radiodirigeret  
FC Ar  
ID 64701