

Aalborg strækning 24

Viby J (Vi)

103,7

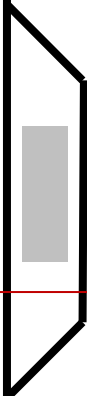

AM 2104

104,x

140



102,8



AM 2102

102,x



VM 1996



AM 2996

99,6

Hasselager (Hc)

98,7

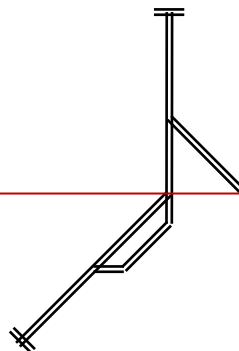

Linieblok
FC Sd

FC Sd

Hørning (Hx)

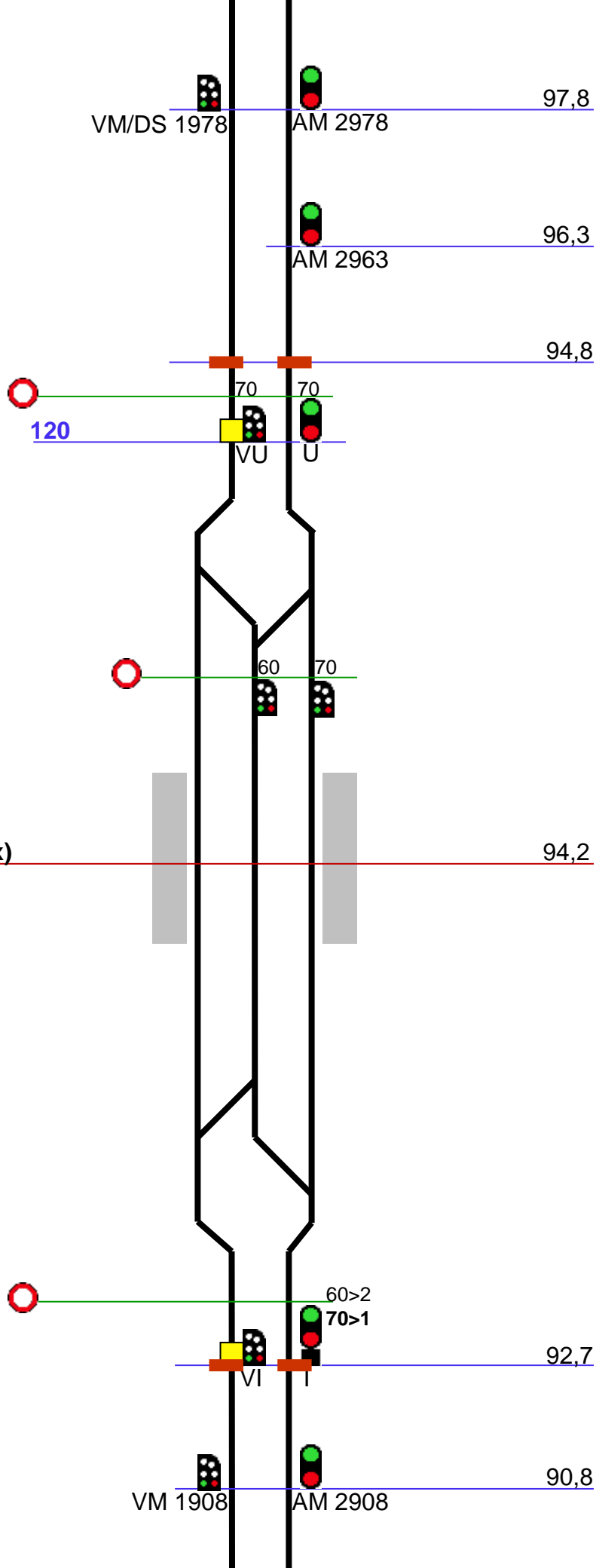

Linieblok
FC Sd

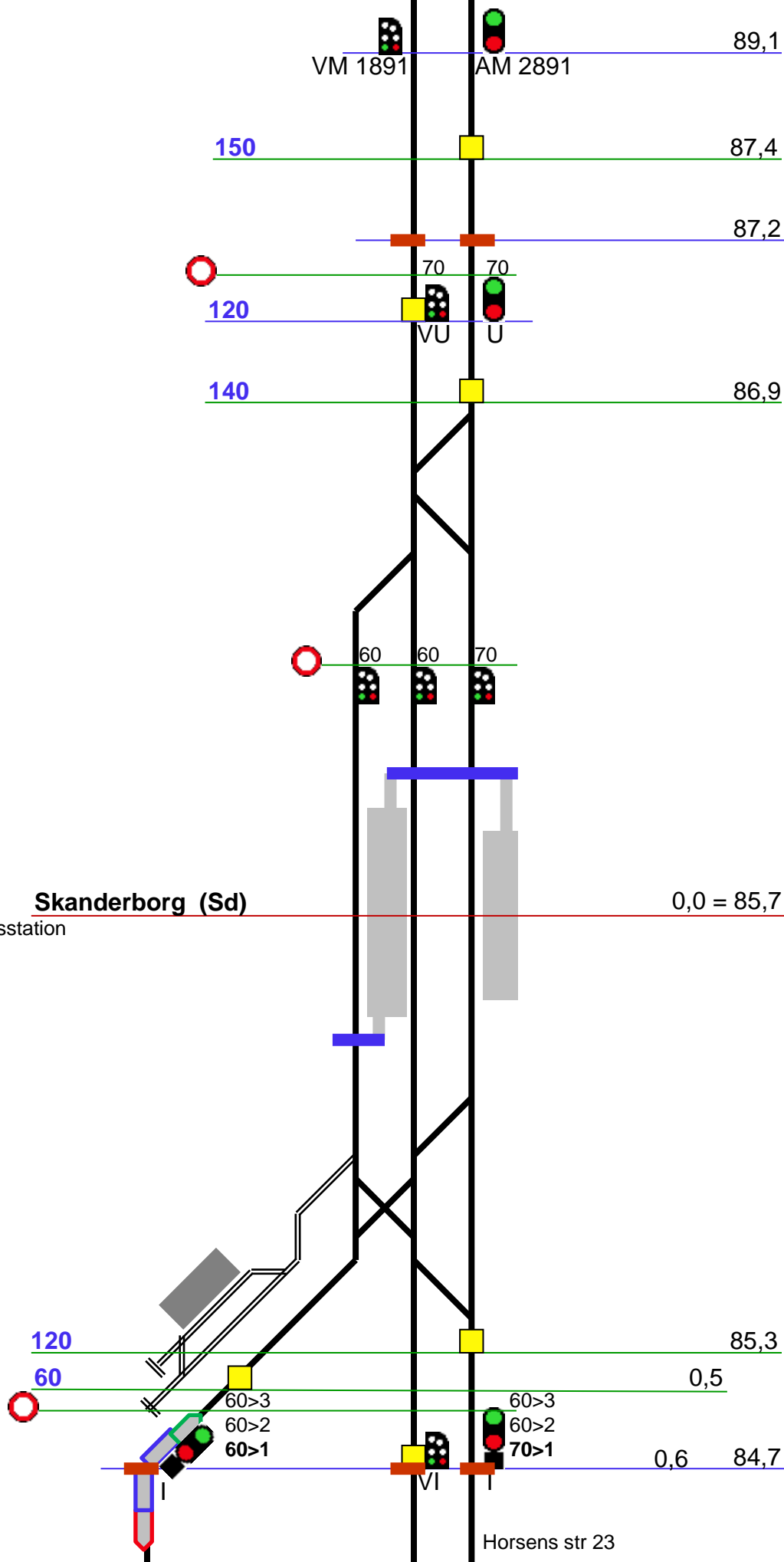

Skanderborg (Sd)

Overgangsstation
ID 65643

Horsens str 23

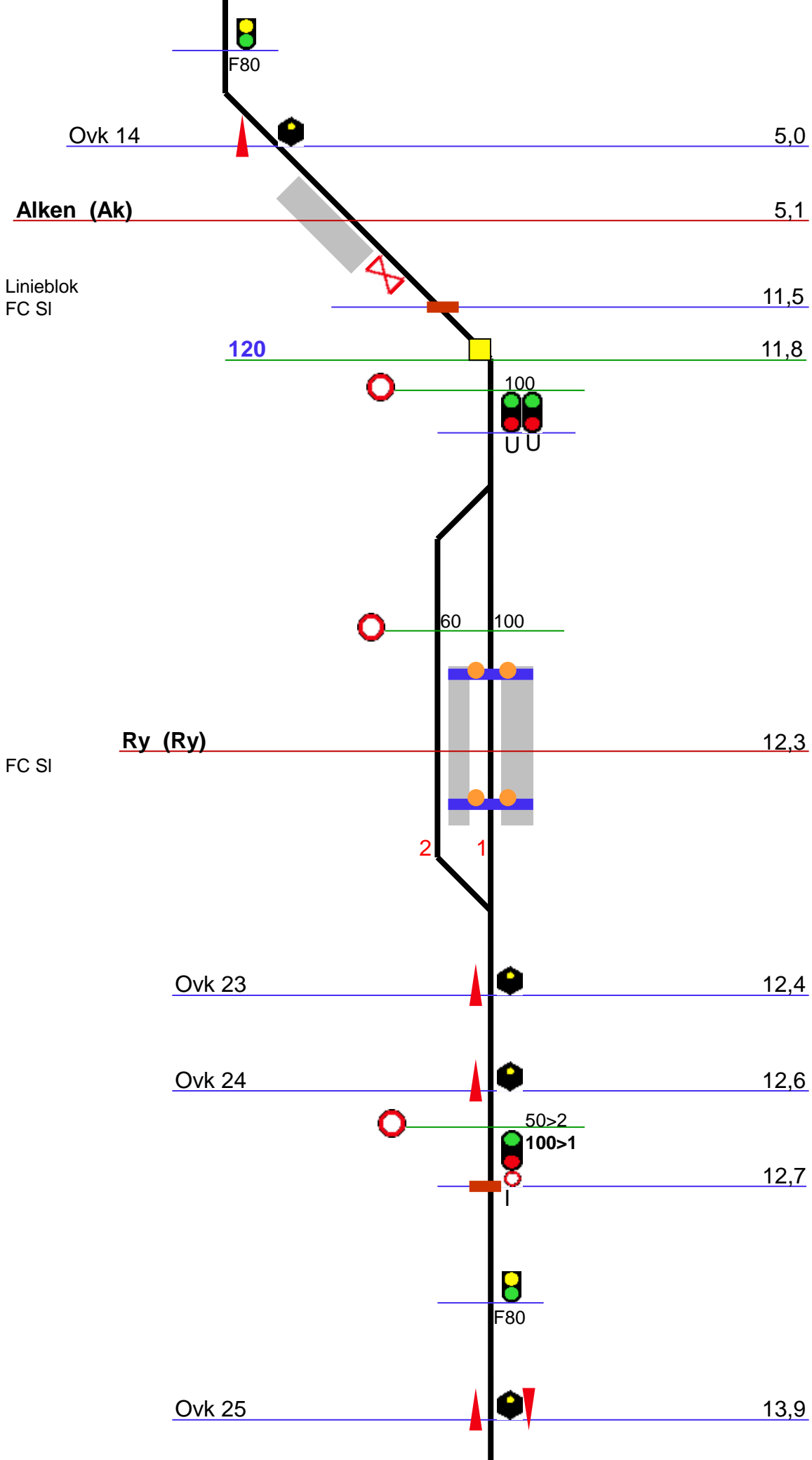

Linieblok
FC SI

FC SI

Linieblok
FC SI

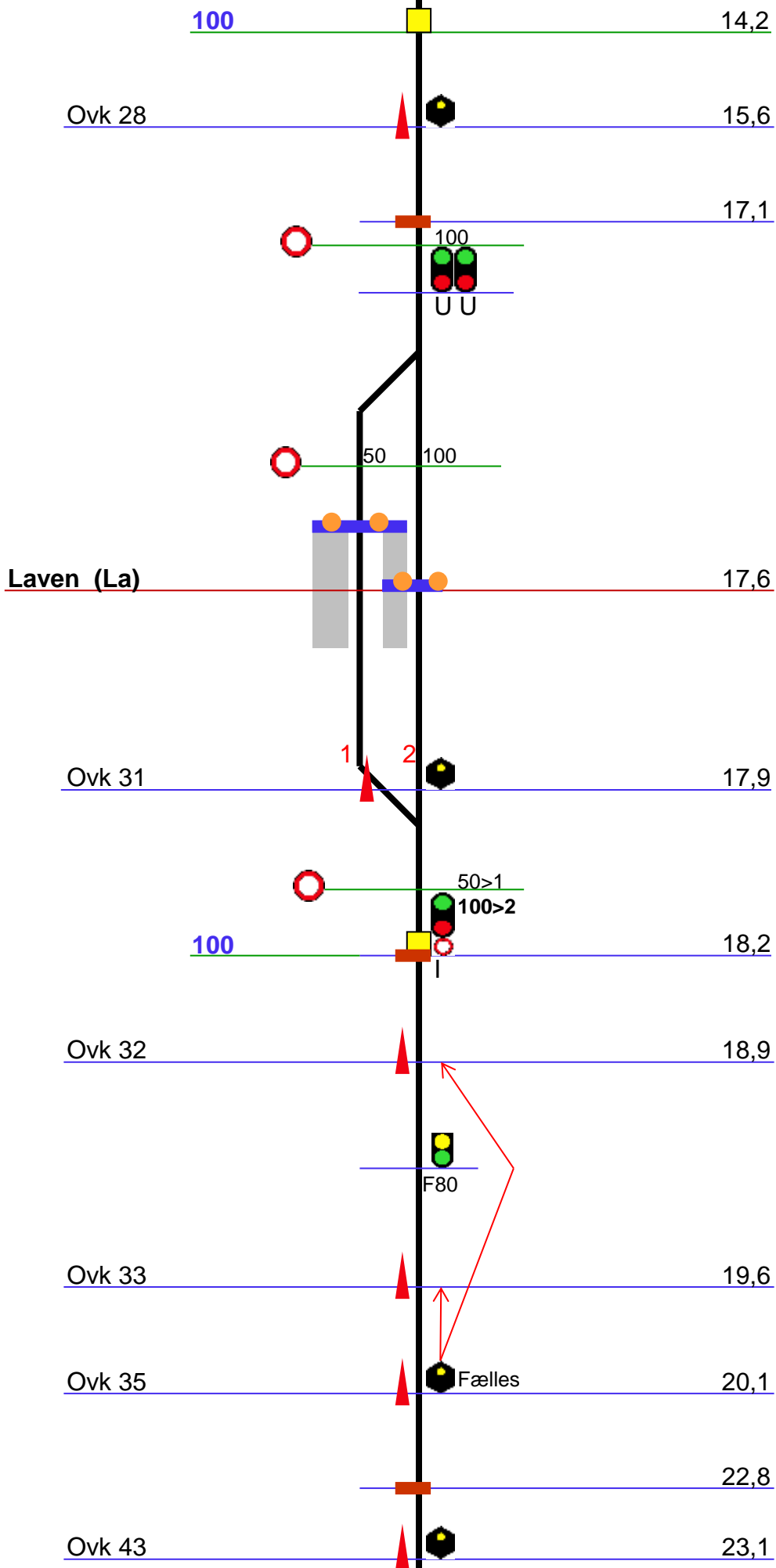

FC SI

Linieblok
FC SI

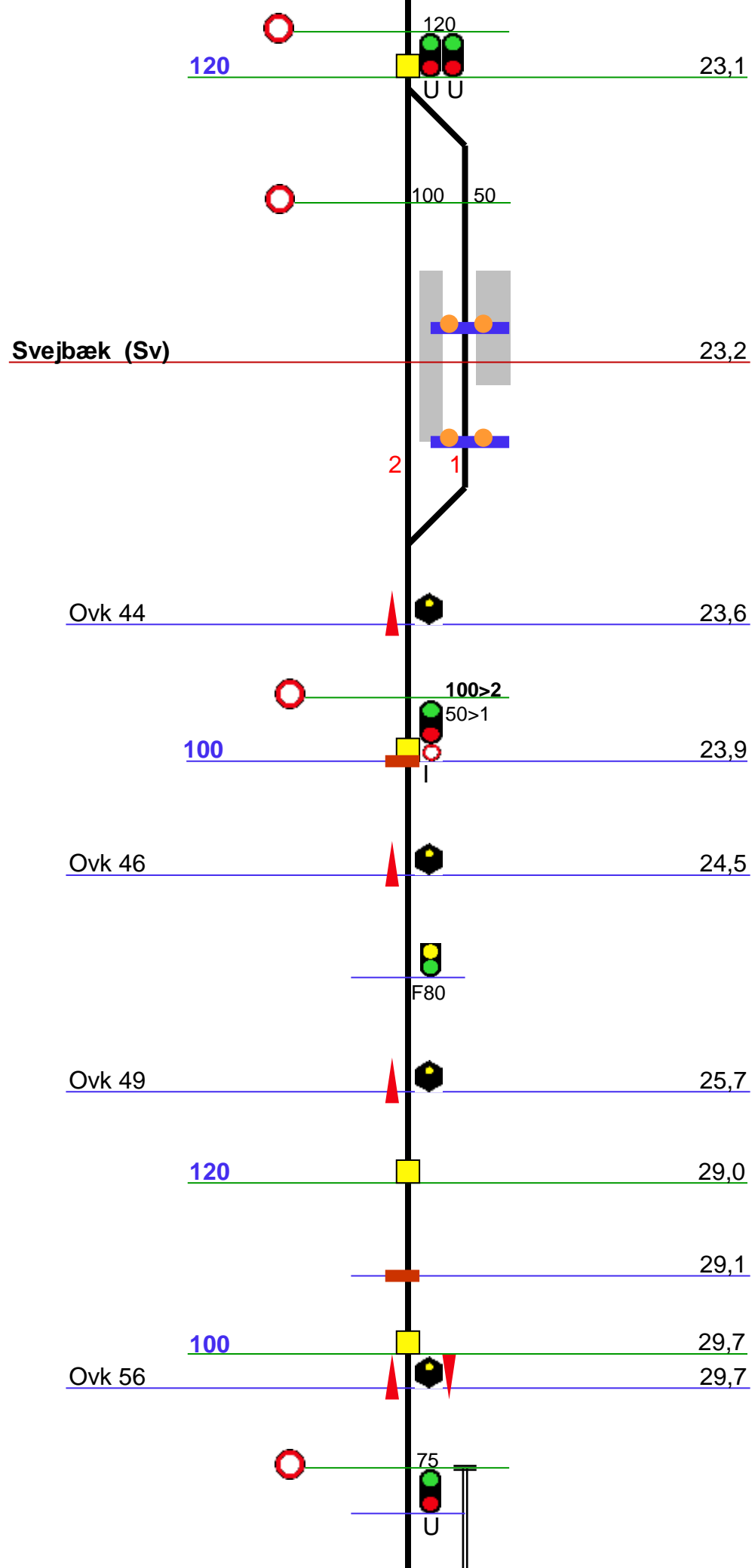

Silkeborg (SI)
Overgangsstation

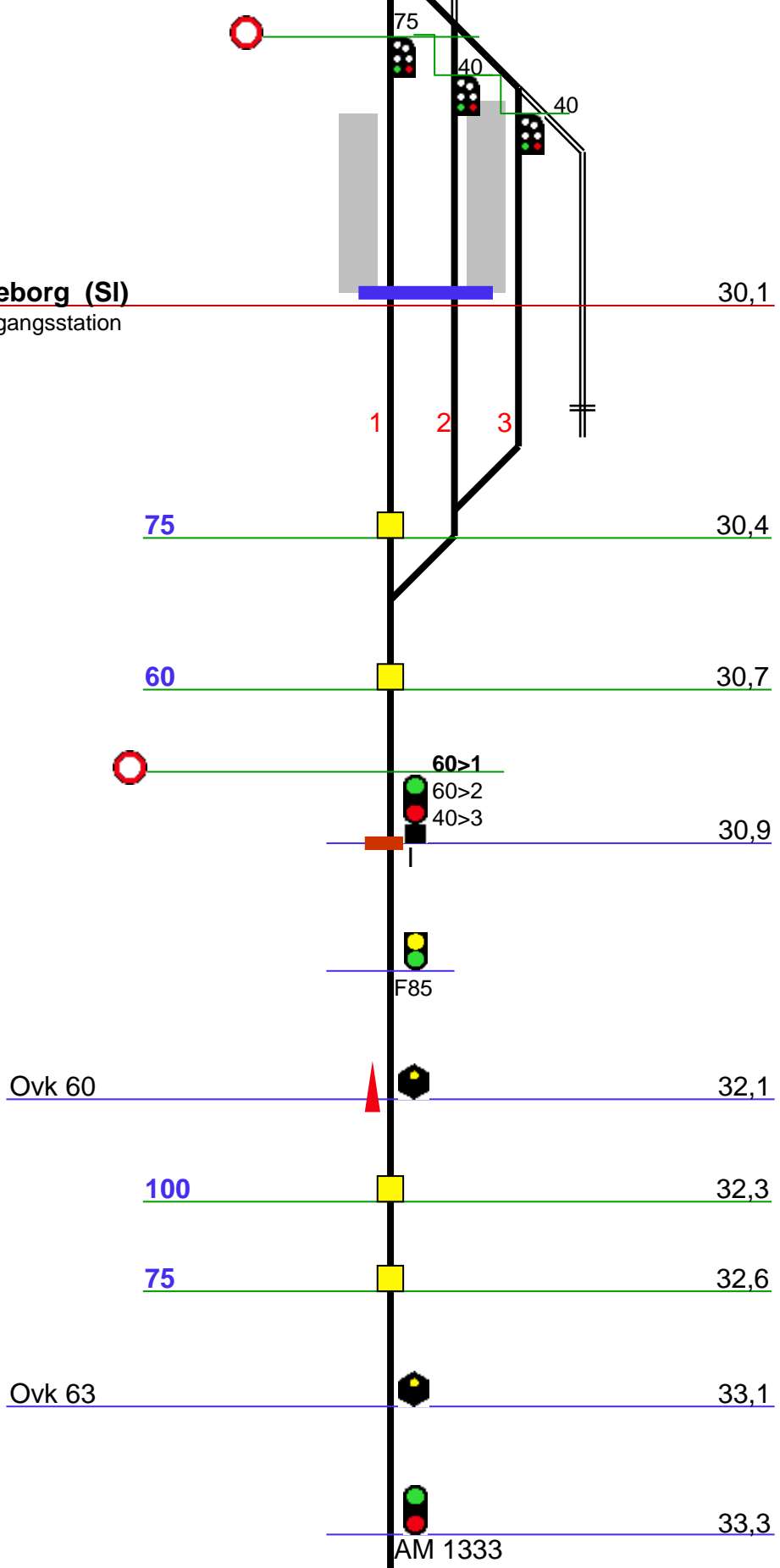

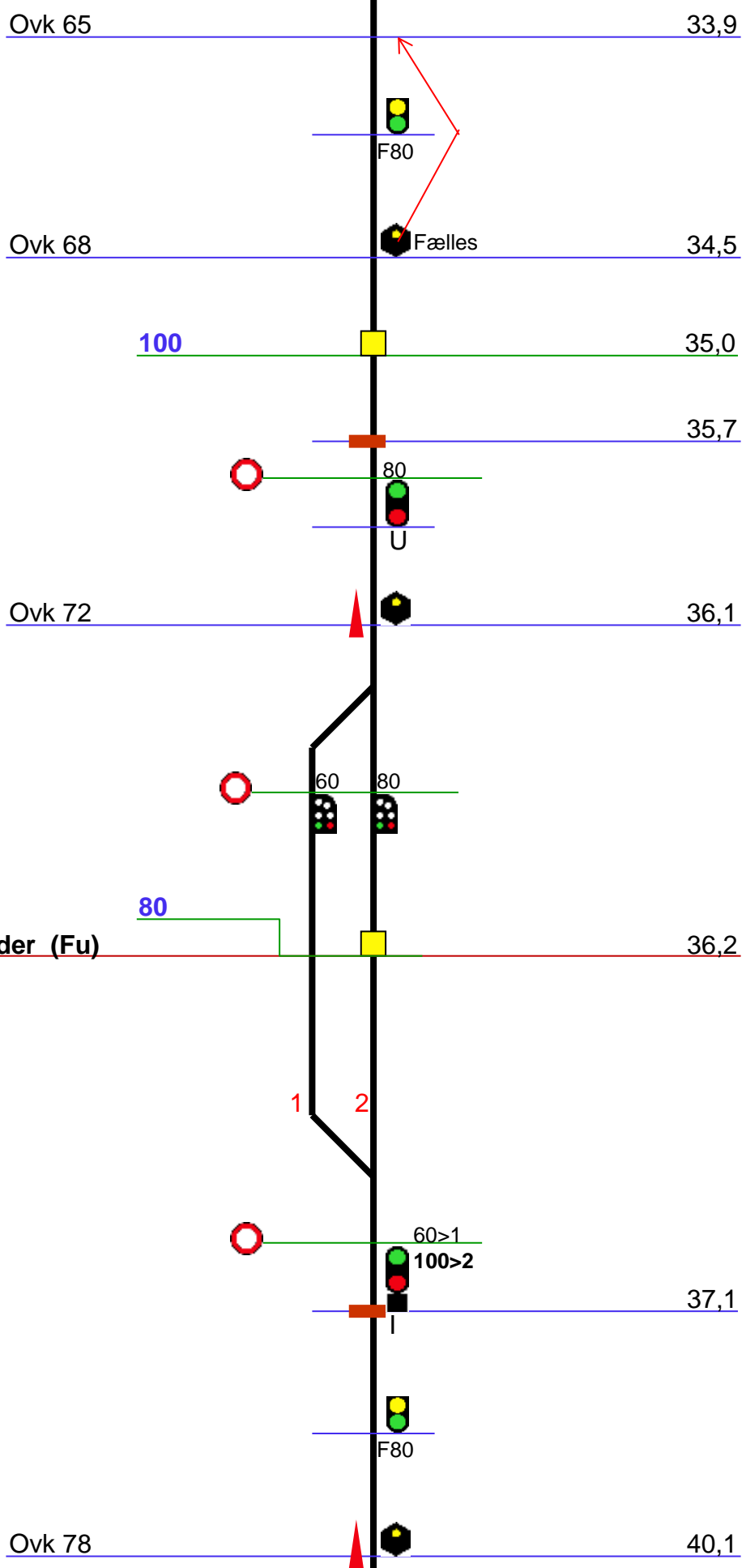

Linieblok
FC SI

FC SI

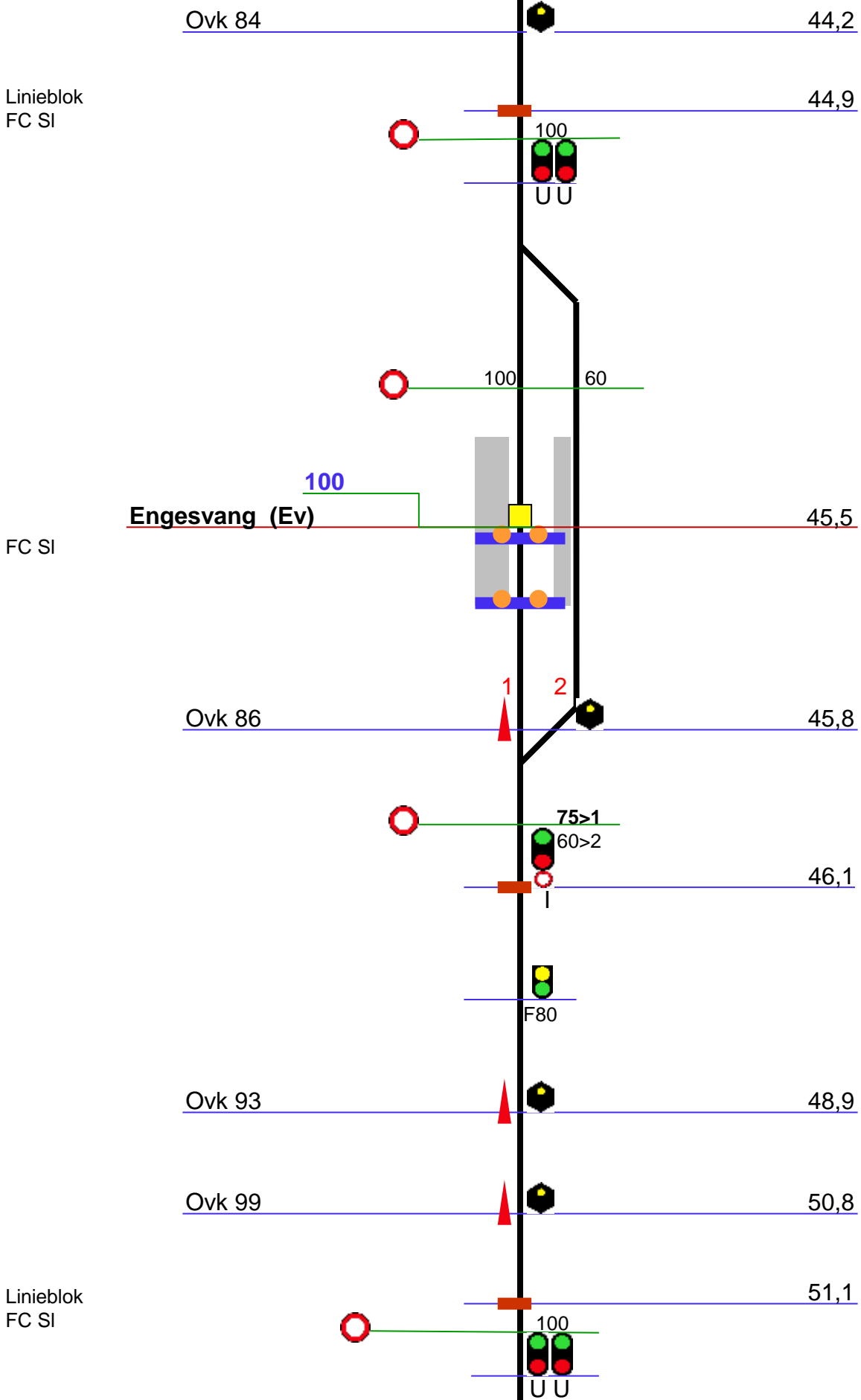

FC SI

Bording (Bg)

Linieblok
FC SI

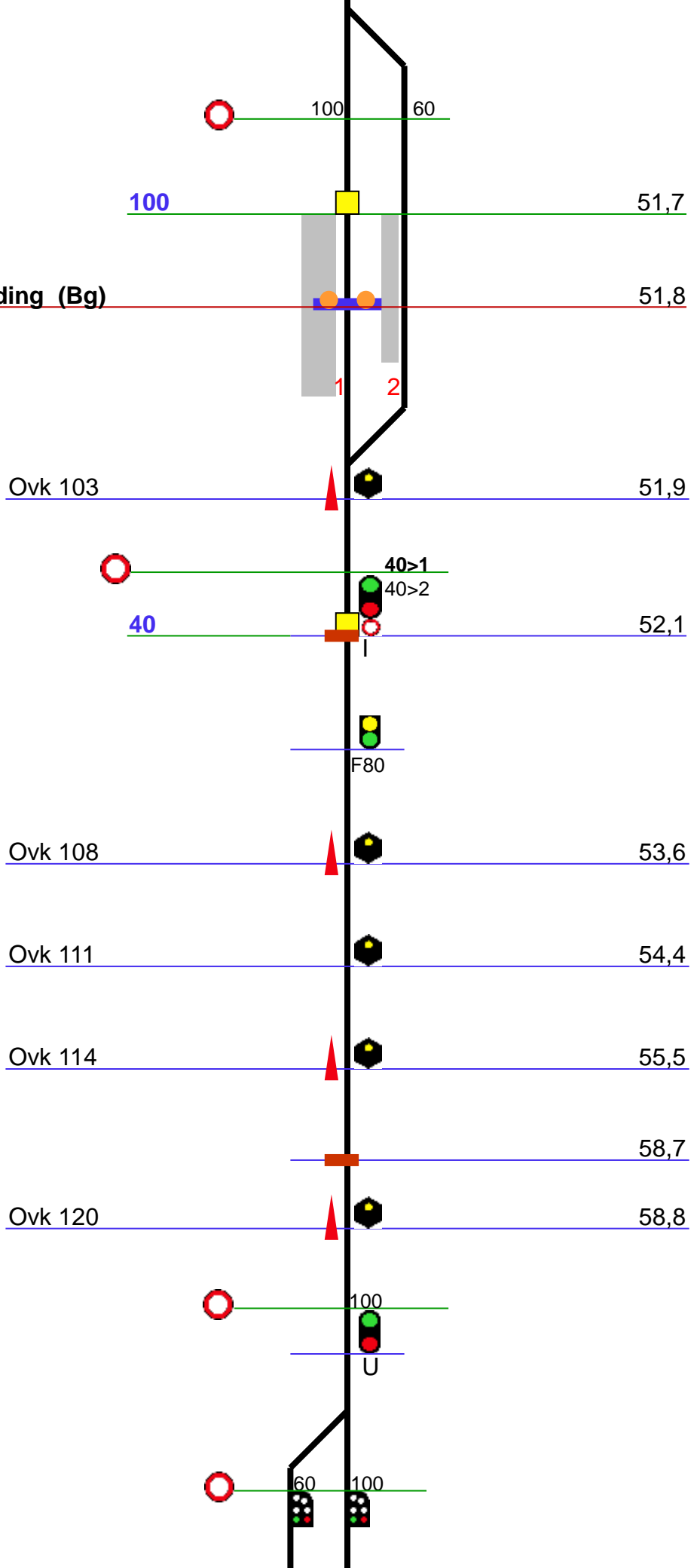

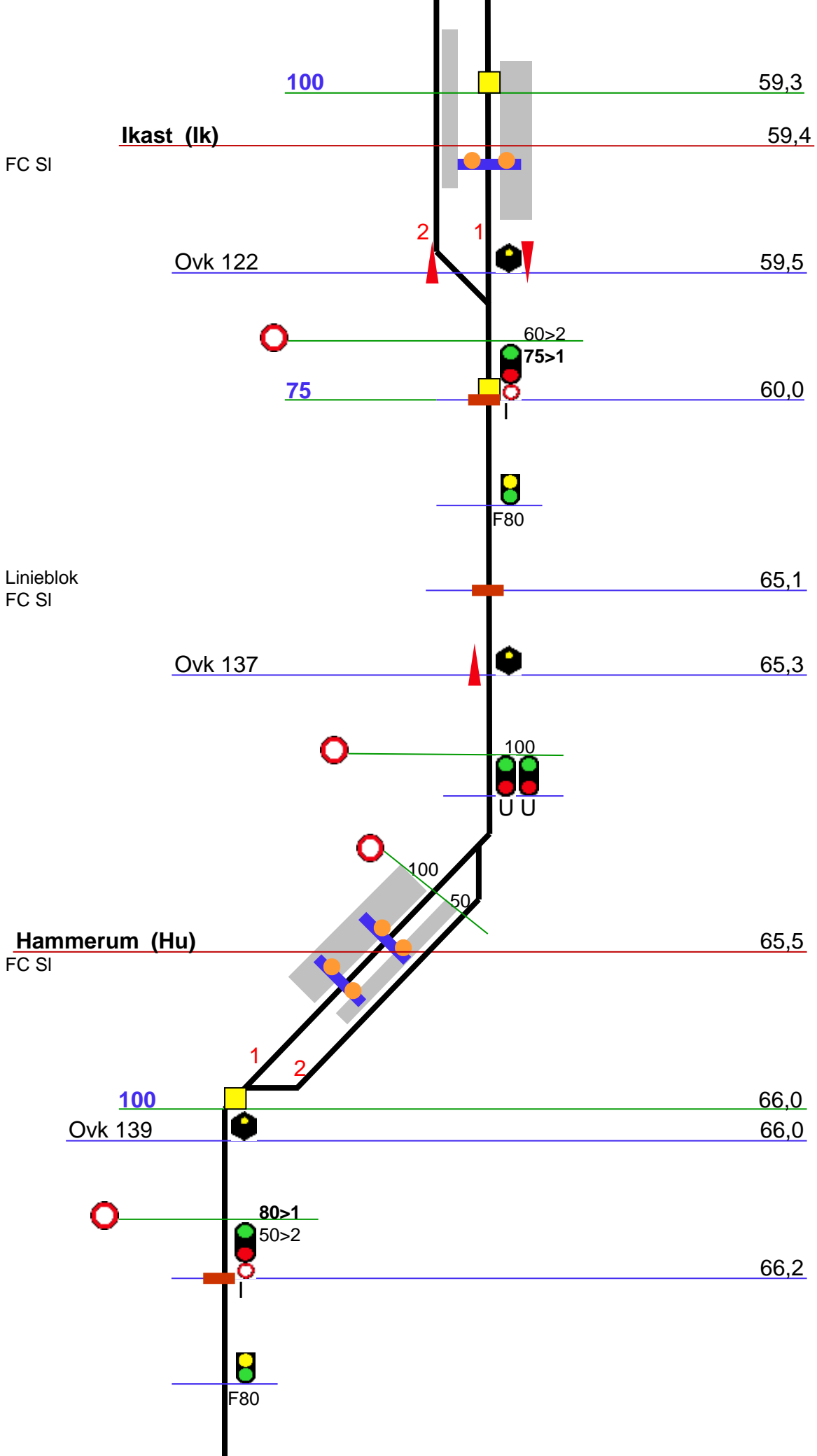

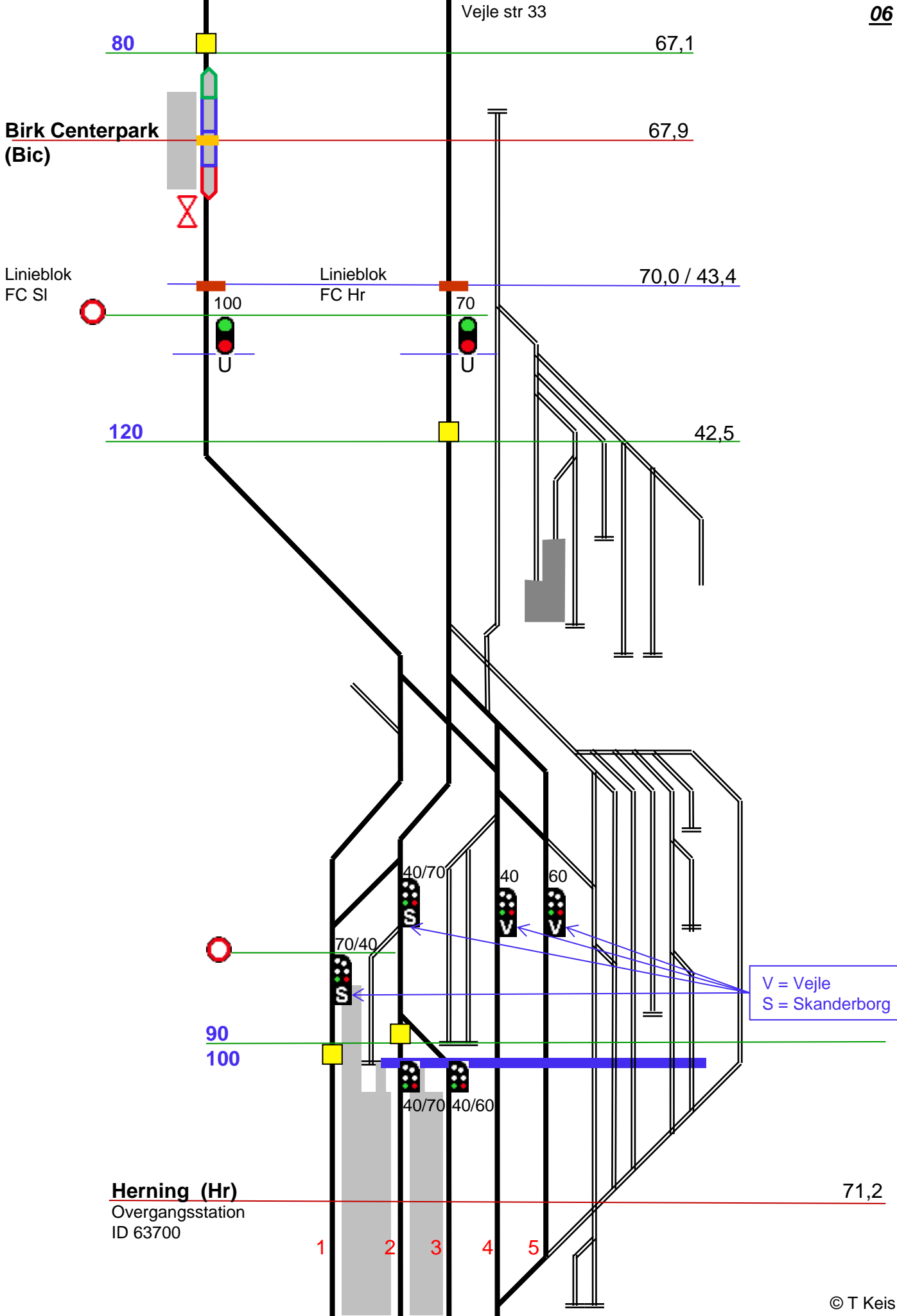

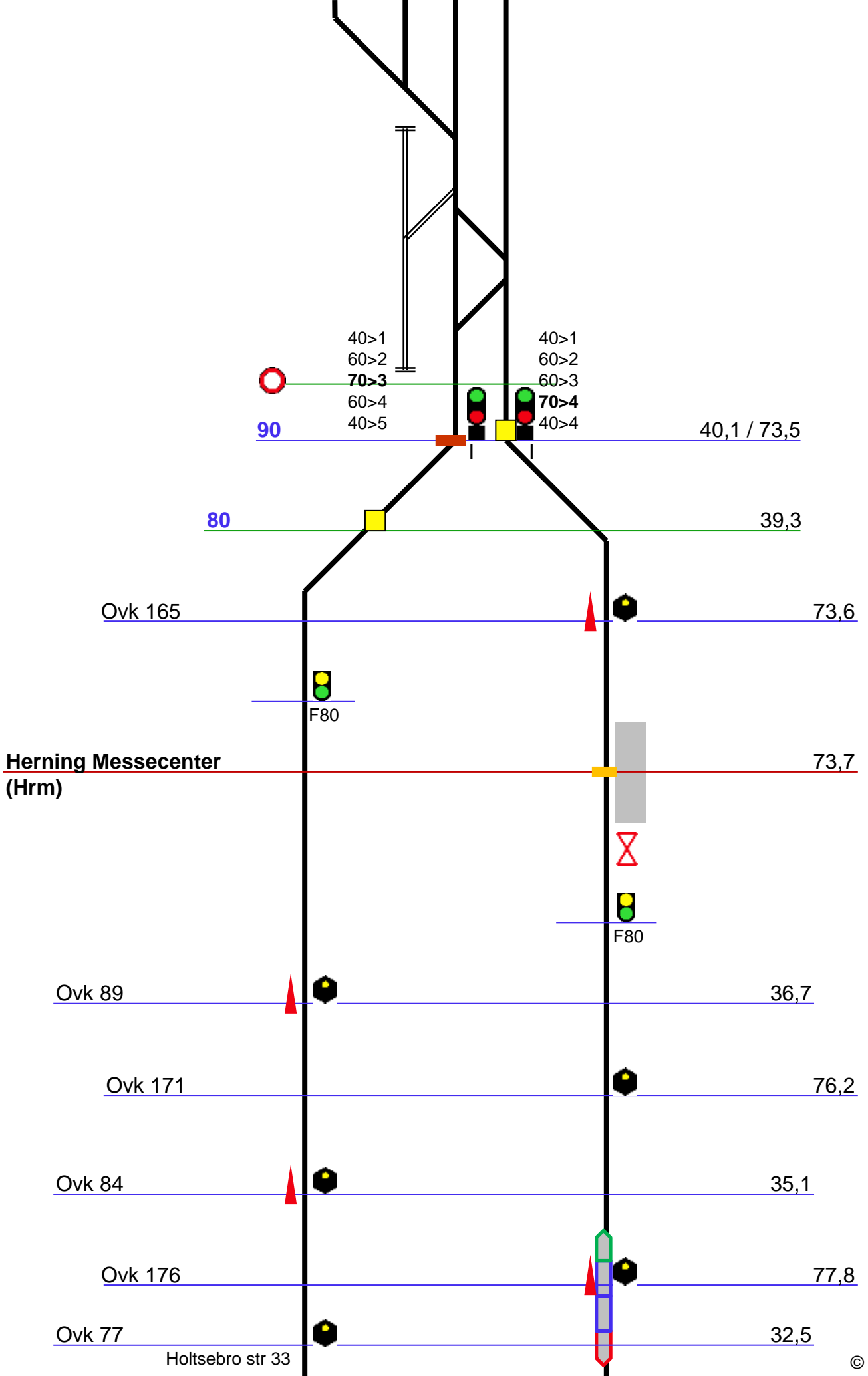

Linieblok
FC Es

FC Es

Studsgård (Stu)

77,9

Ovk 184a

81,1

Ovk 190

83,0

Ovk 194

84,9

85,3

Ovk 196

85,7

Kilbæk (Kæ)

85,7

86,5

Ovk 202

87,6

