

Viby J (Vi)

103,7



AM 2104

104,x



AM 2102

102,x

140 / 170



101,5



VM 1996



AM 2996

99,6

140 / 150



99,2

Hasselager (Hc)

98,7

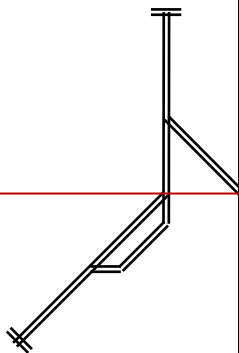

140



98,3

Linieblok
FC Sd

FC Sd

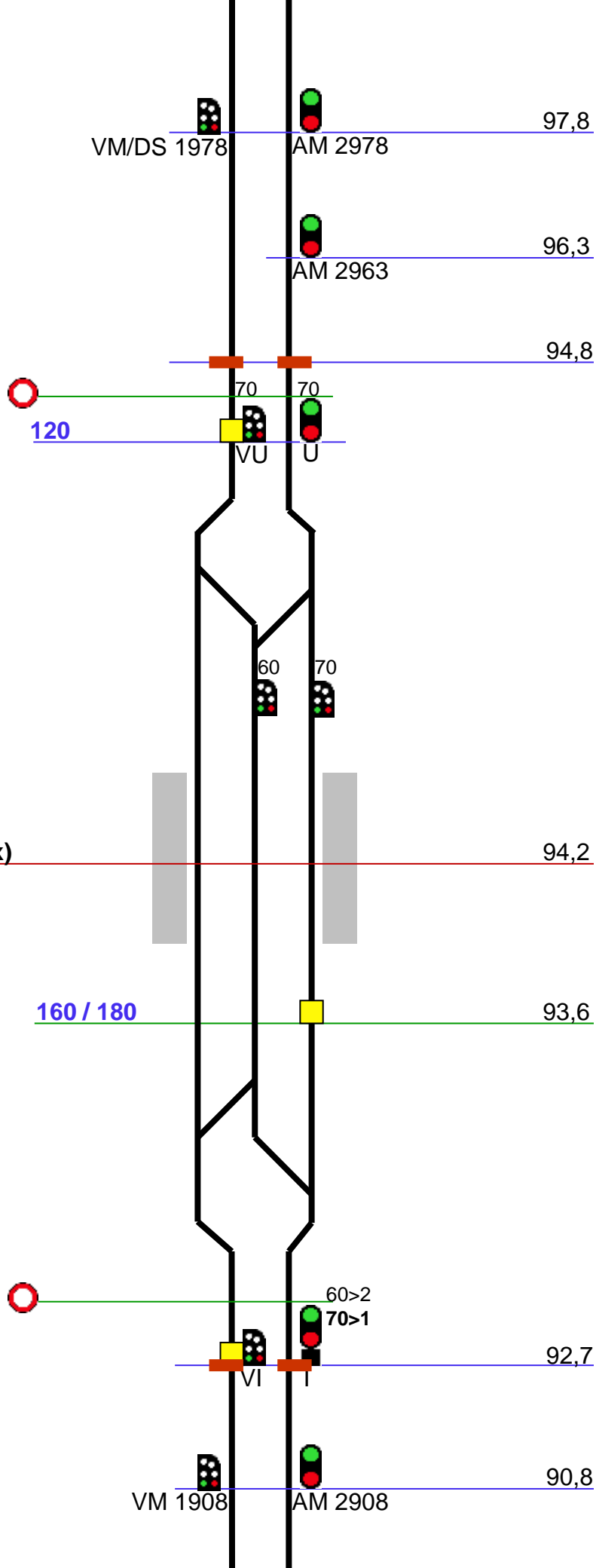

Linieblok
FC Sd

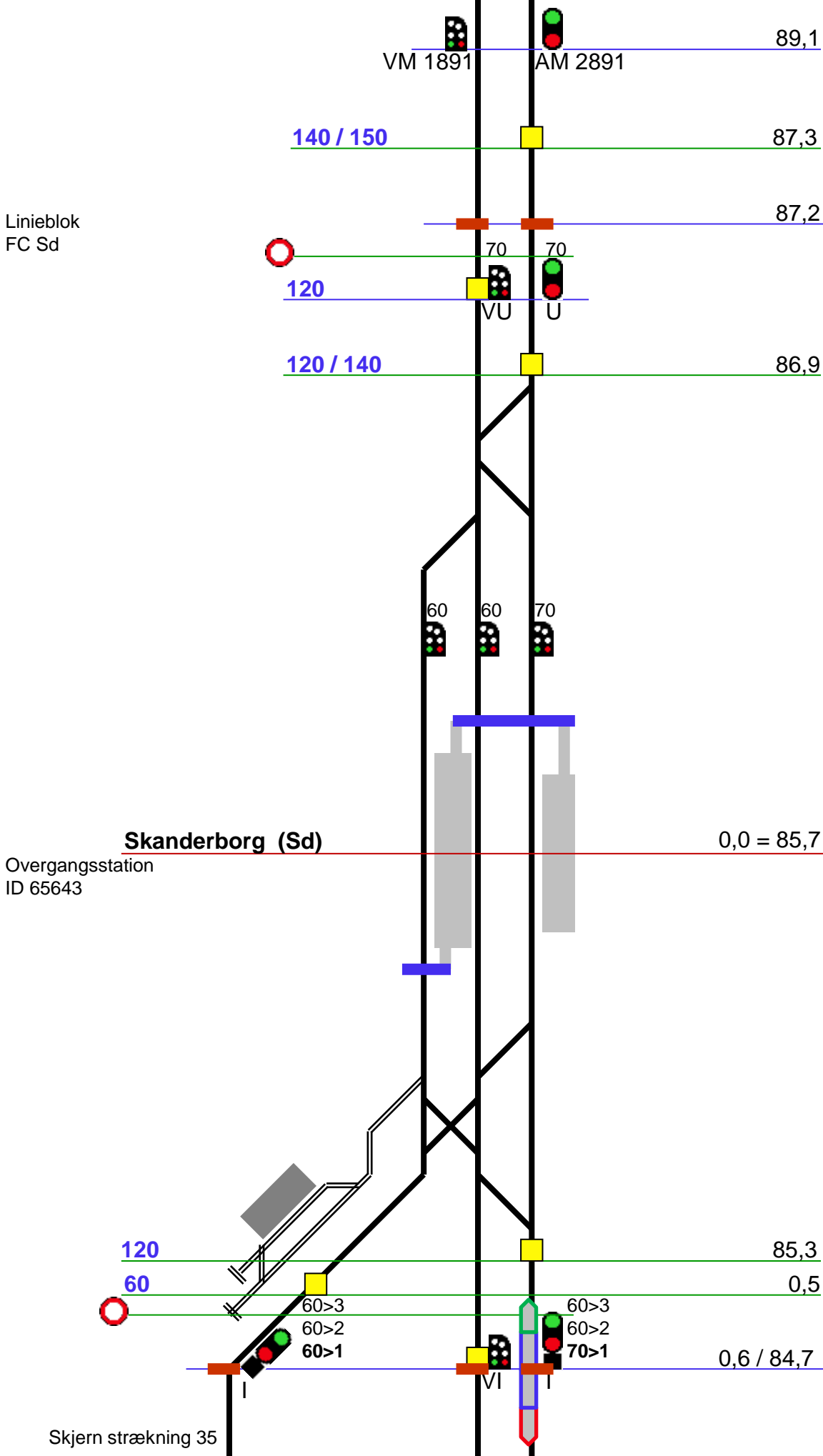

89,1

VM 1891 AM 2891

140 / 150

87,3

87,2



70 70

120

VU U

120 / 140

86,9

60 60 70

Skanderborg (Sd)

0,0 = 85,7

Overgangsstation
ID 65643

120

85,3

60

0,5



60>3
60>2
60>1

60>3
60>2
70>1

0,6 / 84,7

Skjern strækning 35

Linieblok
FC Sd

FC Sd

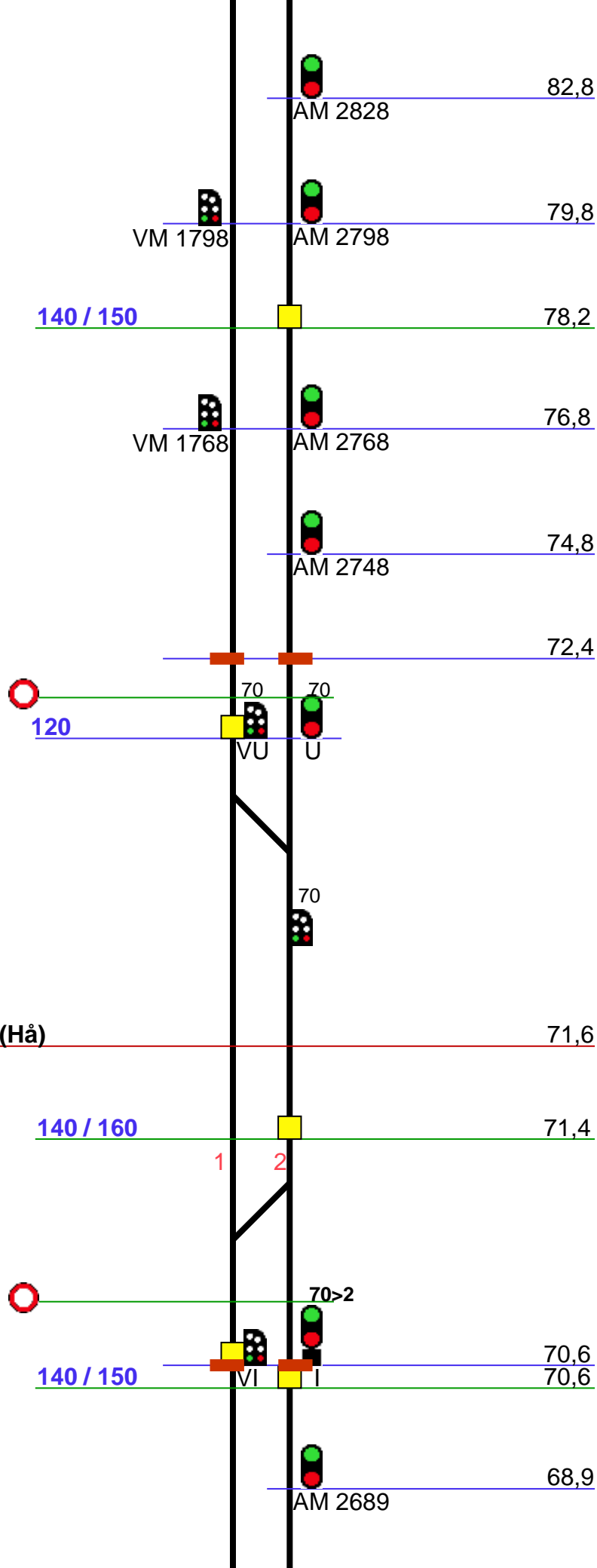

Linieblok
FC Sd

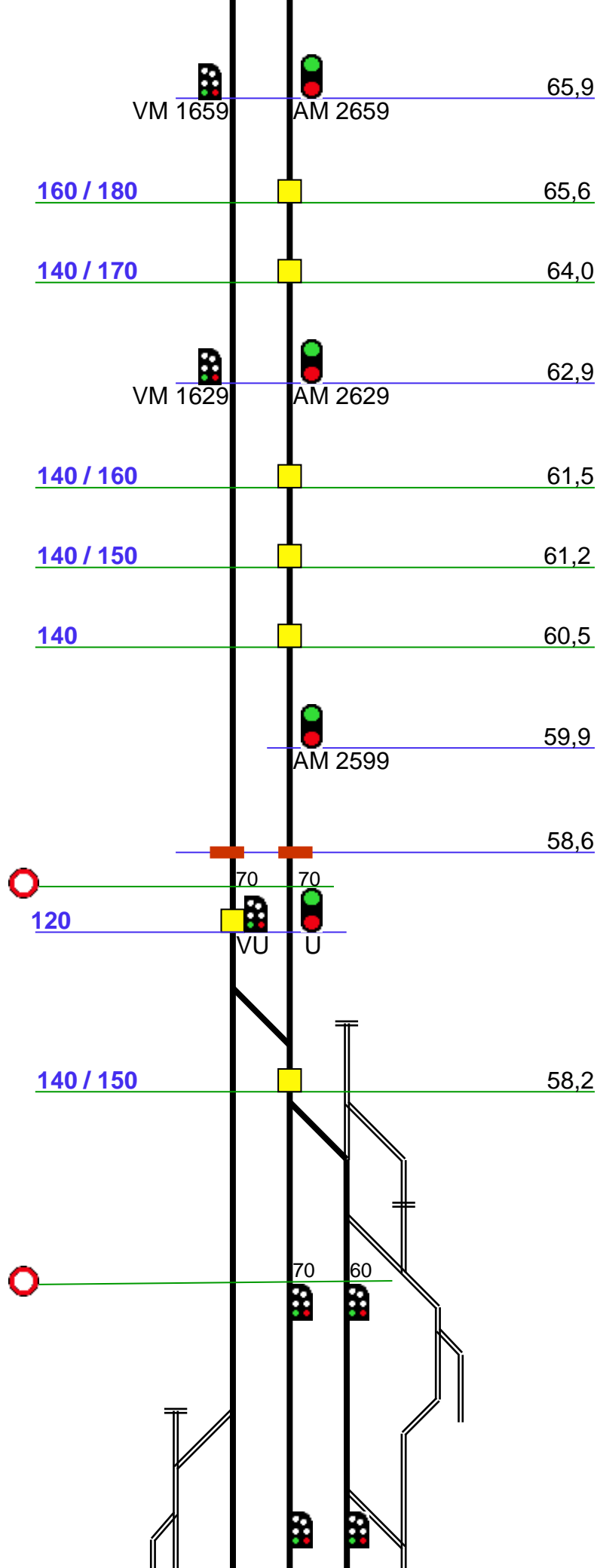

Horsens (Hs)

57,1

Overgangsstation
ID 65623

120

56,9

3 2 1



70>2
60>1

110

56,0

56,0



140 / 150

55,1

AM 2543

54,3

140 / 160

51,5

AM 2515

160

51,0

AM 2490

49,0

AM 2465

46,5

AM 2435

43,5



41,8

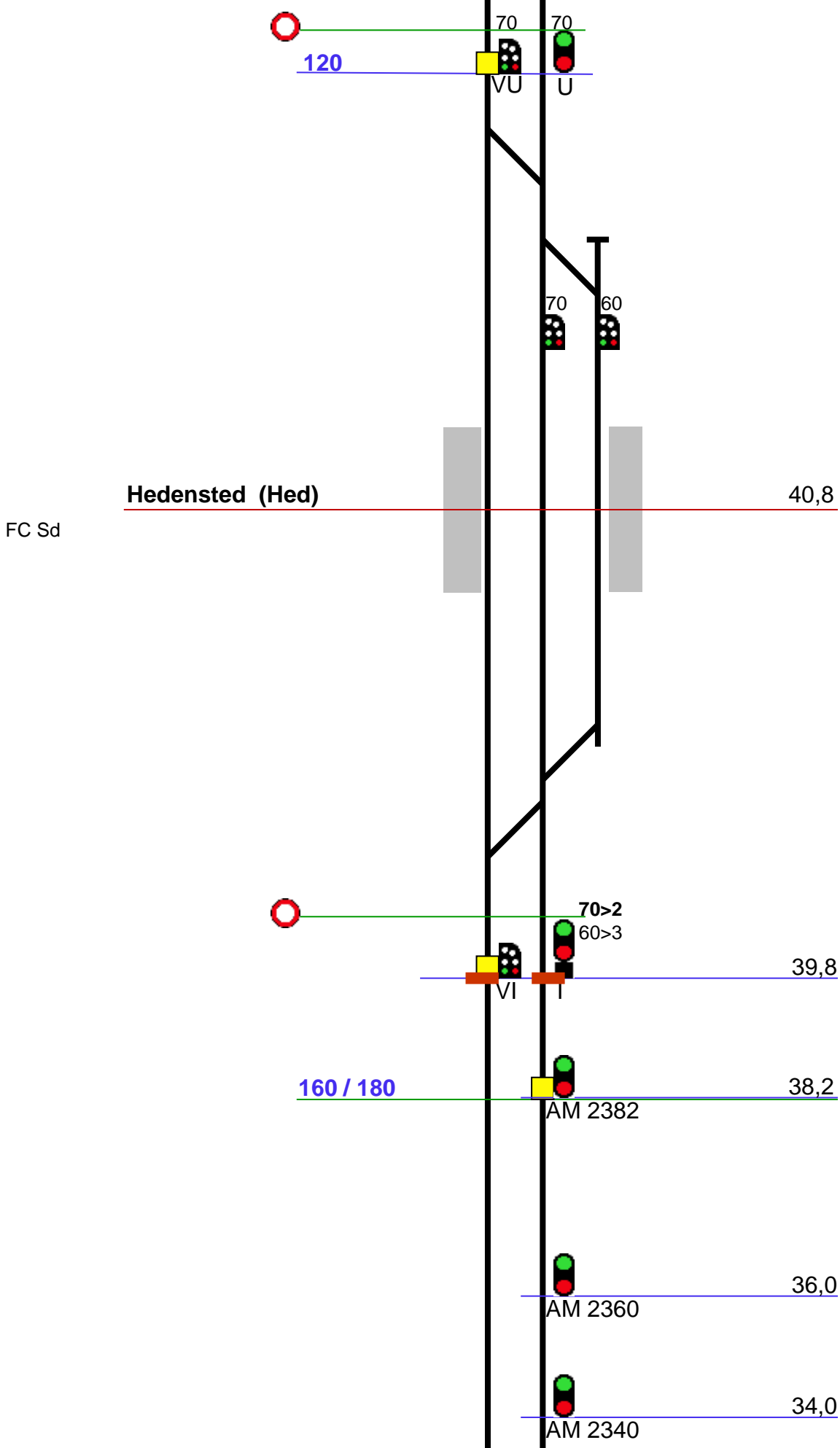

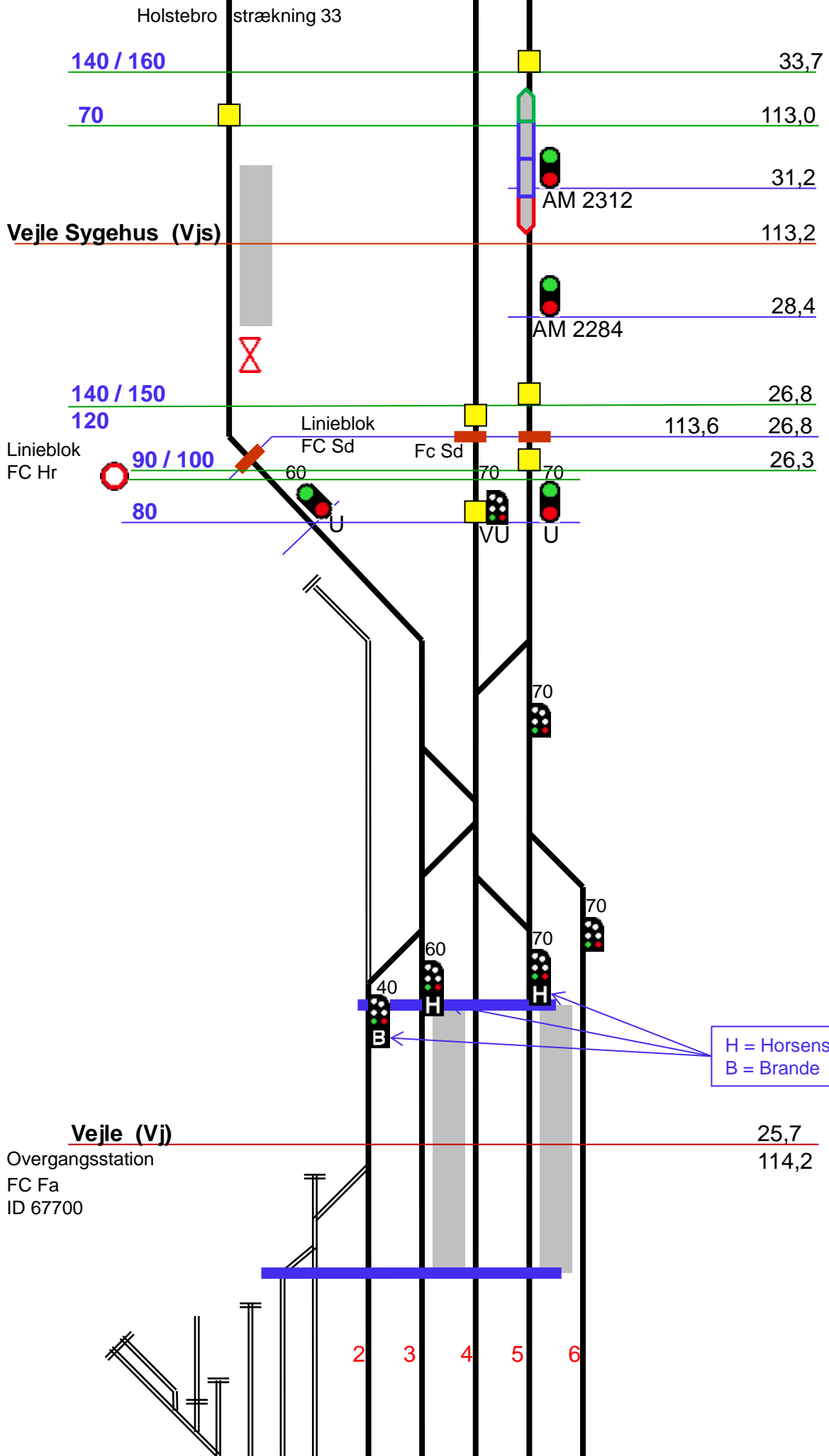

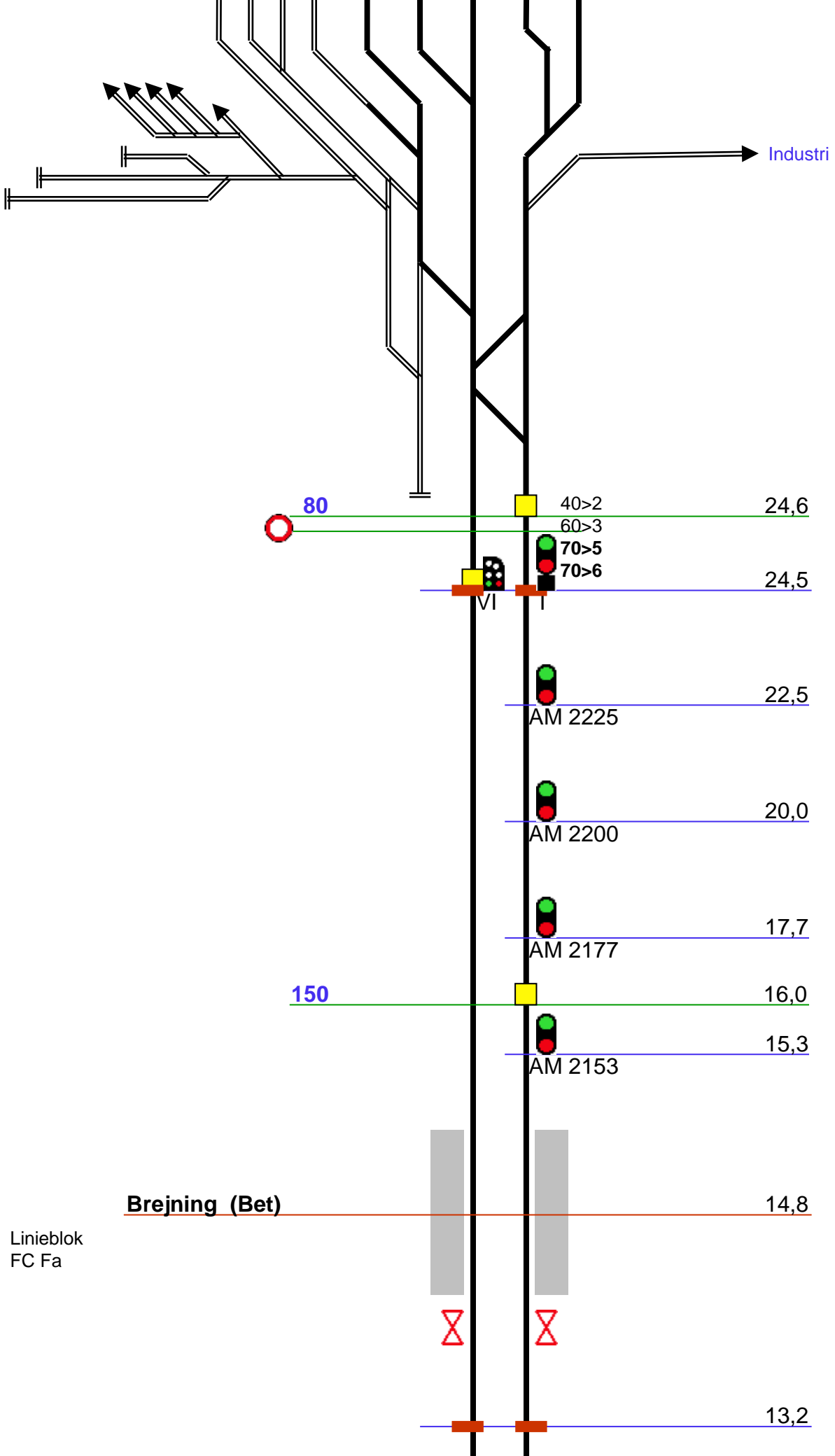

Linieblok
FC Fa

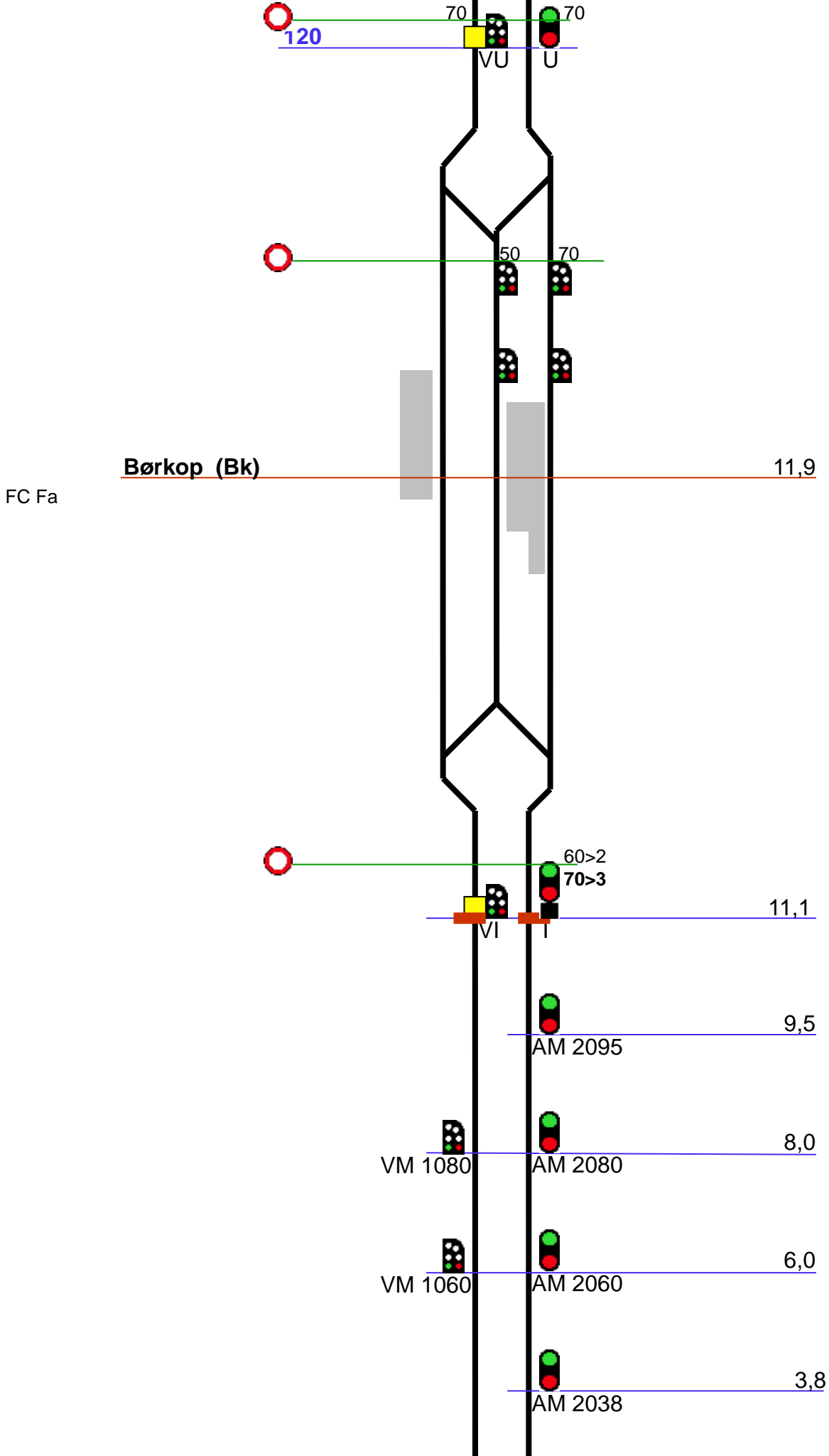

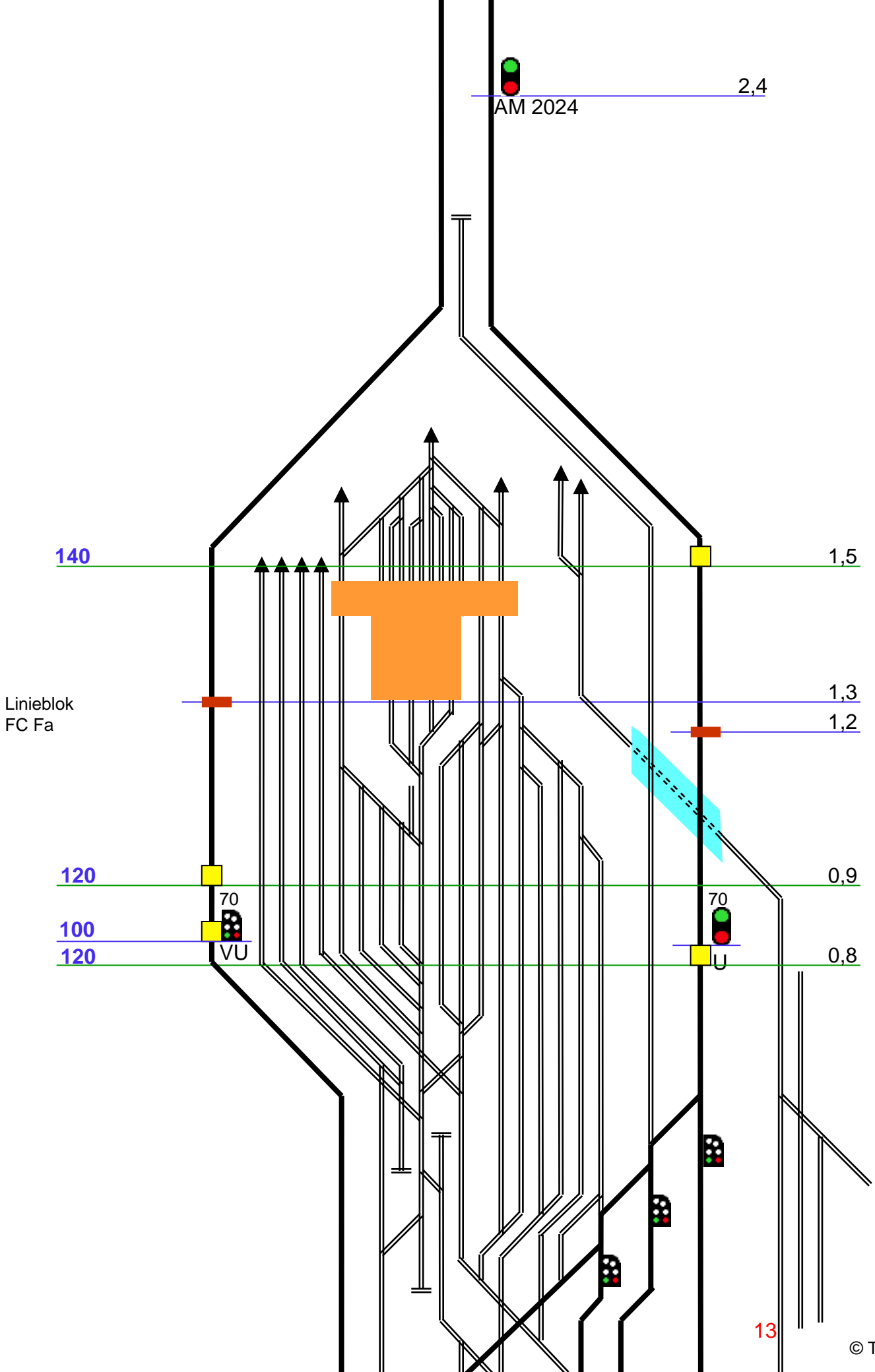

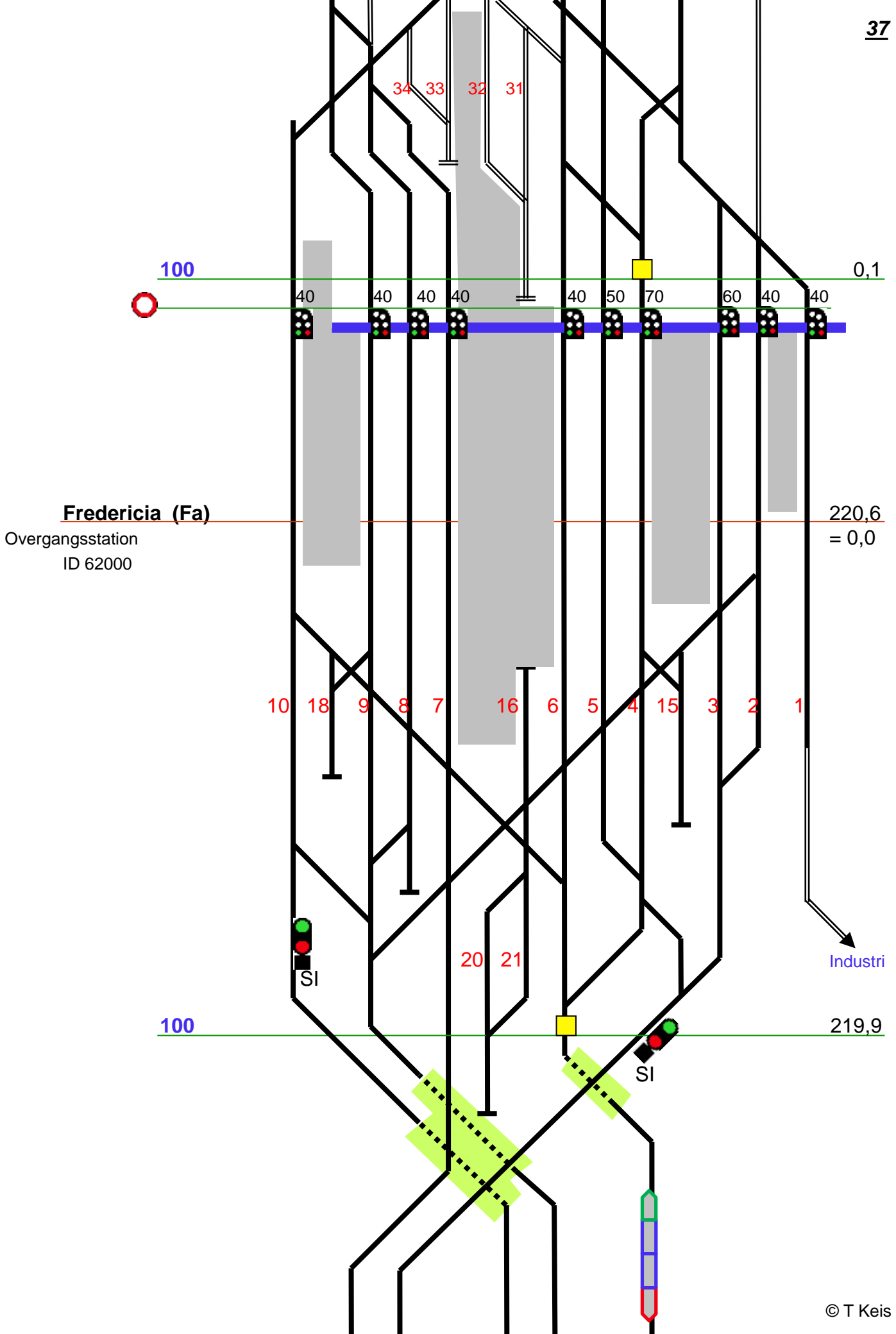

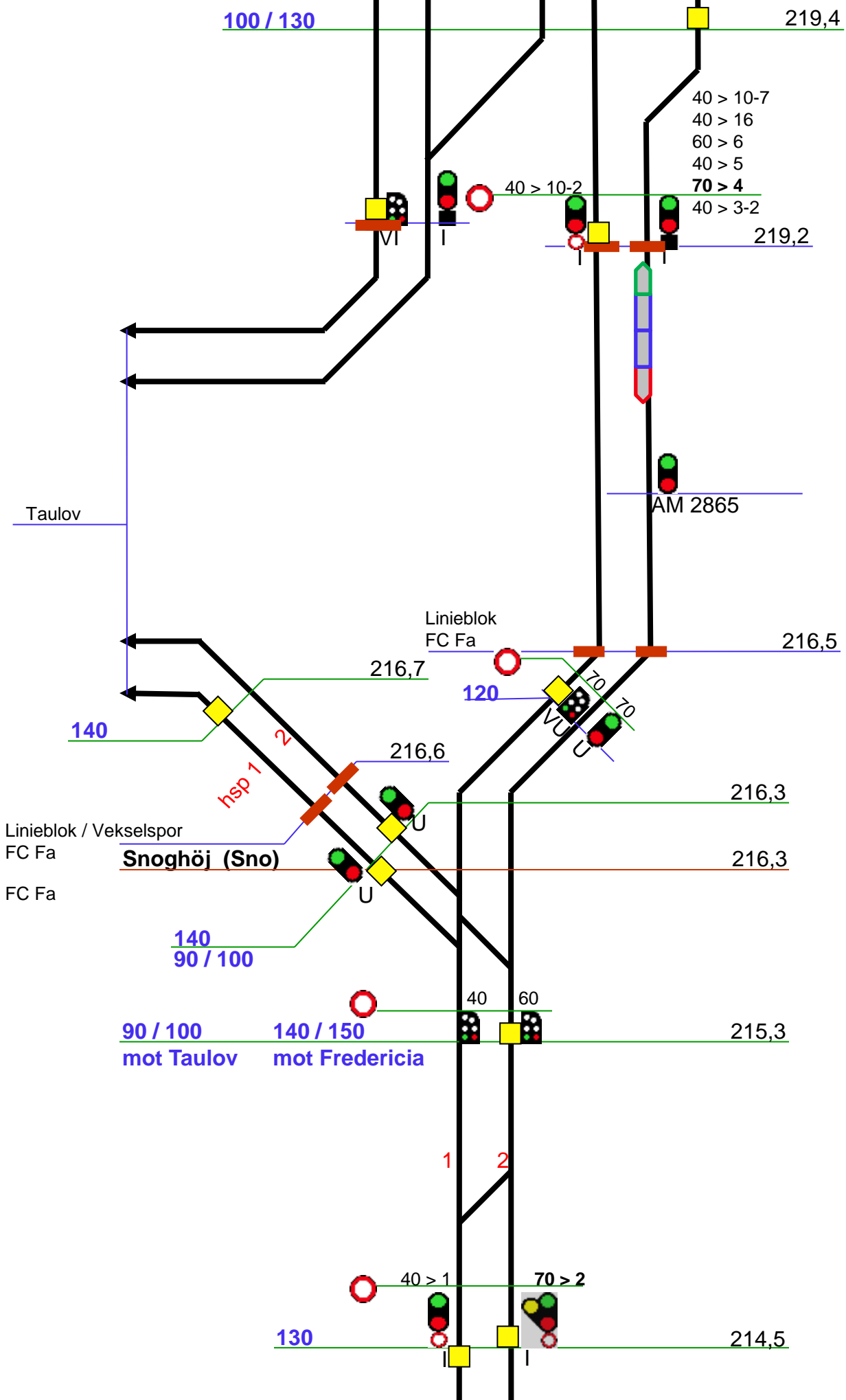

Linieblok
FC Fa

FC Fa

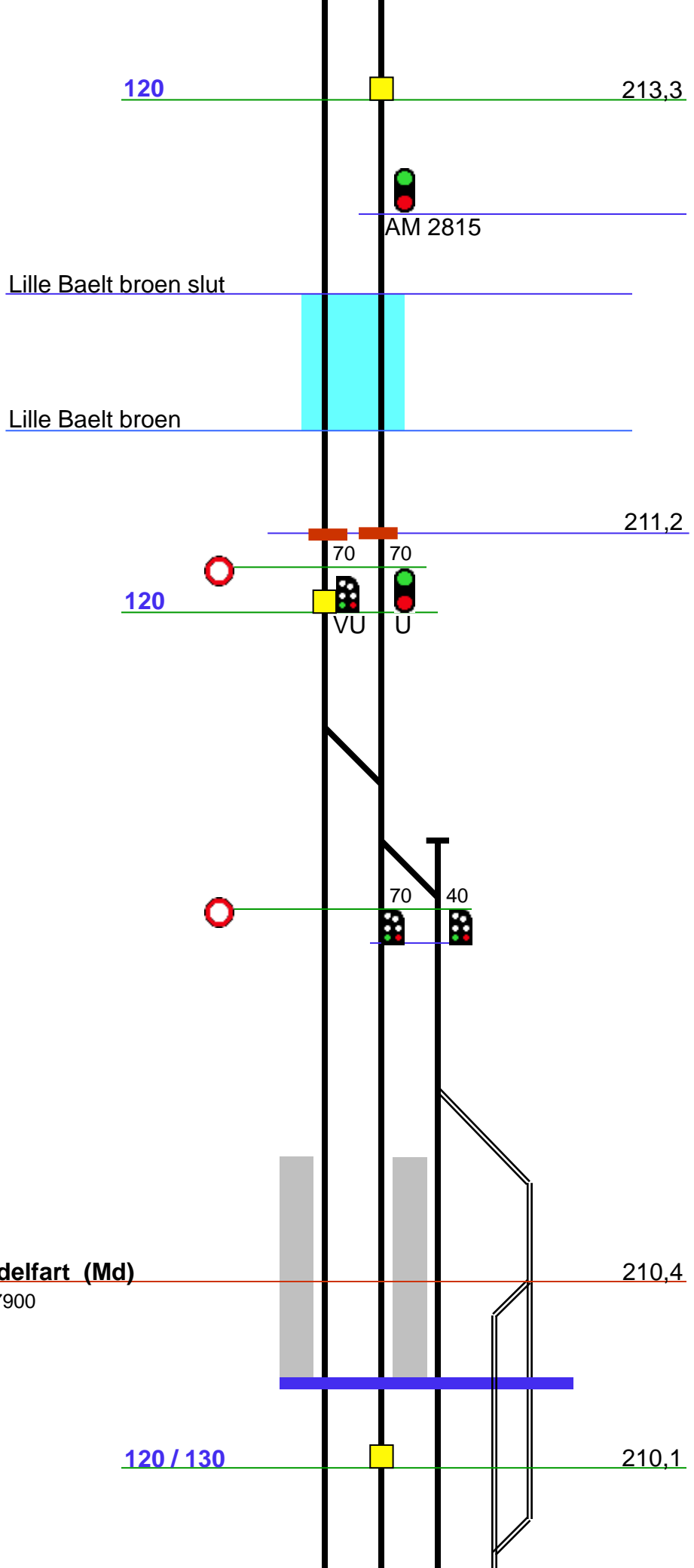

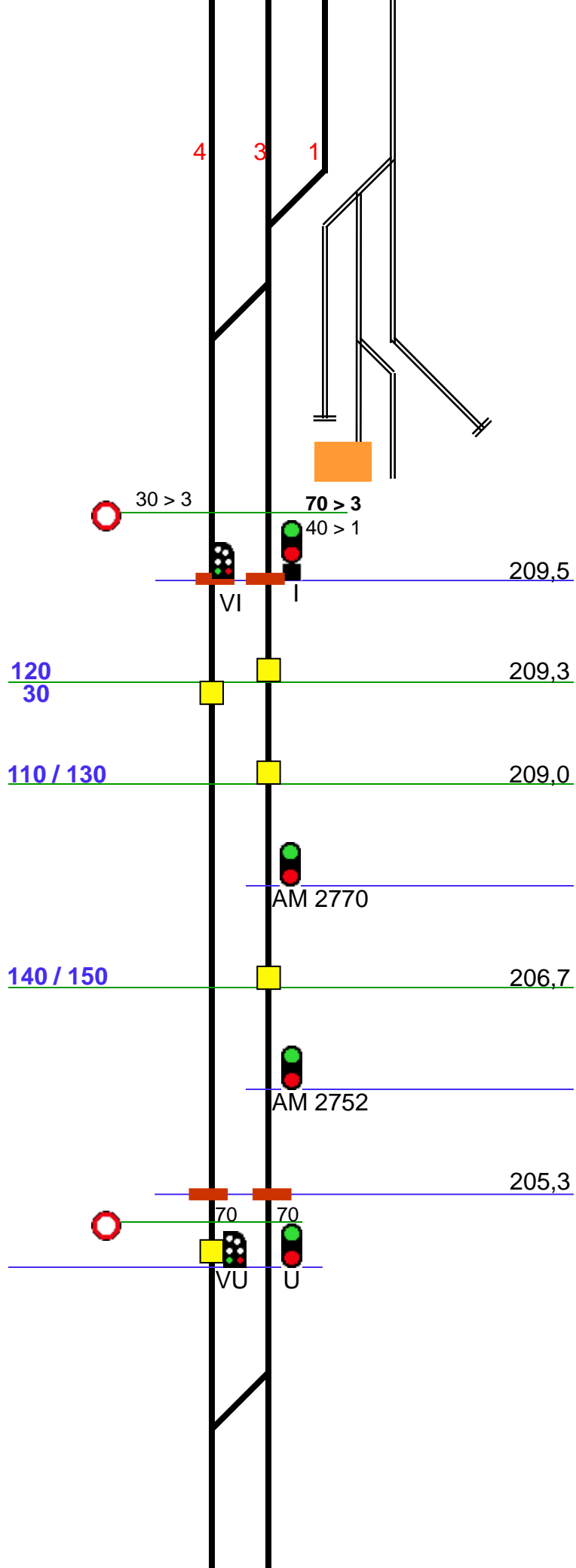

Linieblok
FC Fa

FC Fa

Kavslunde (Ka) 204,3

3 2 1

60 > 3
70 > 1

203,1

VM 1698 AM 2698

Nörre-Åby (Na) 200,1
200,0

VM 1676 AM 2676

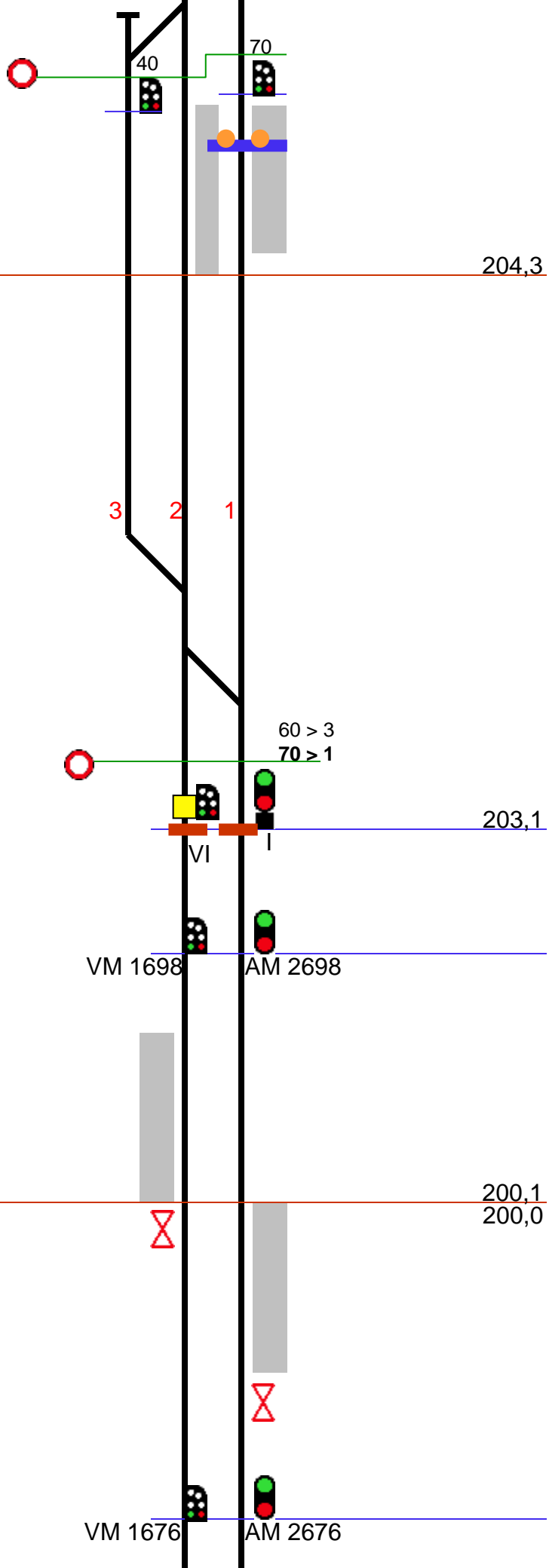

FC Fa

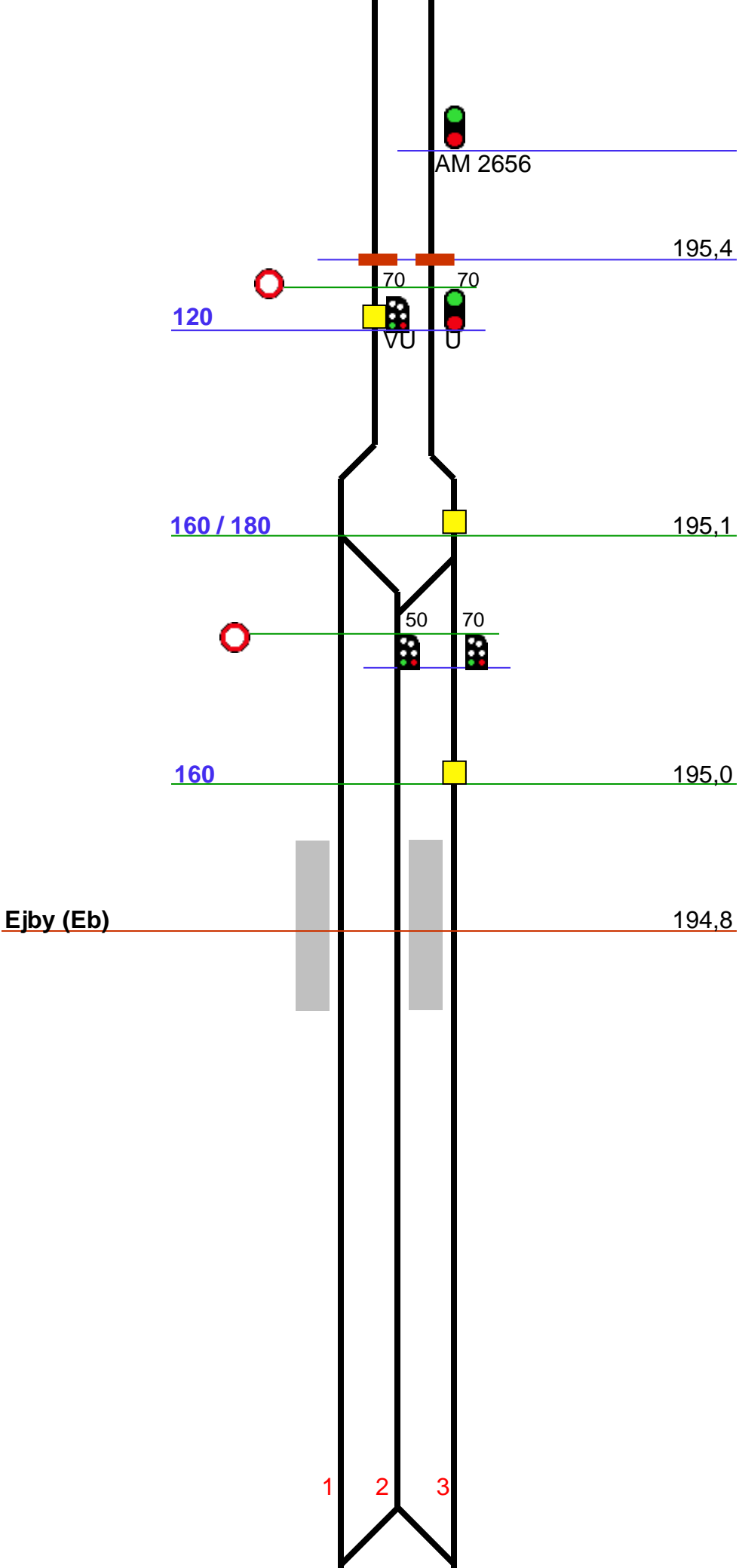

FC Fa

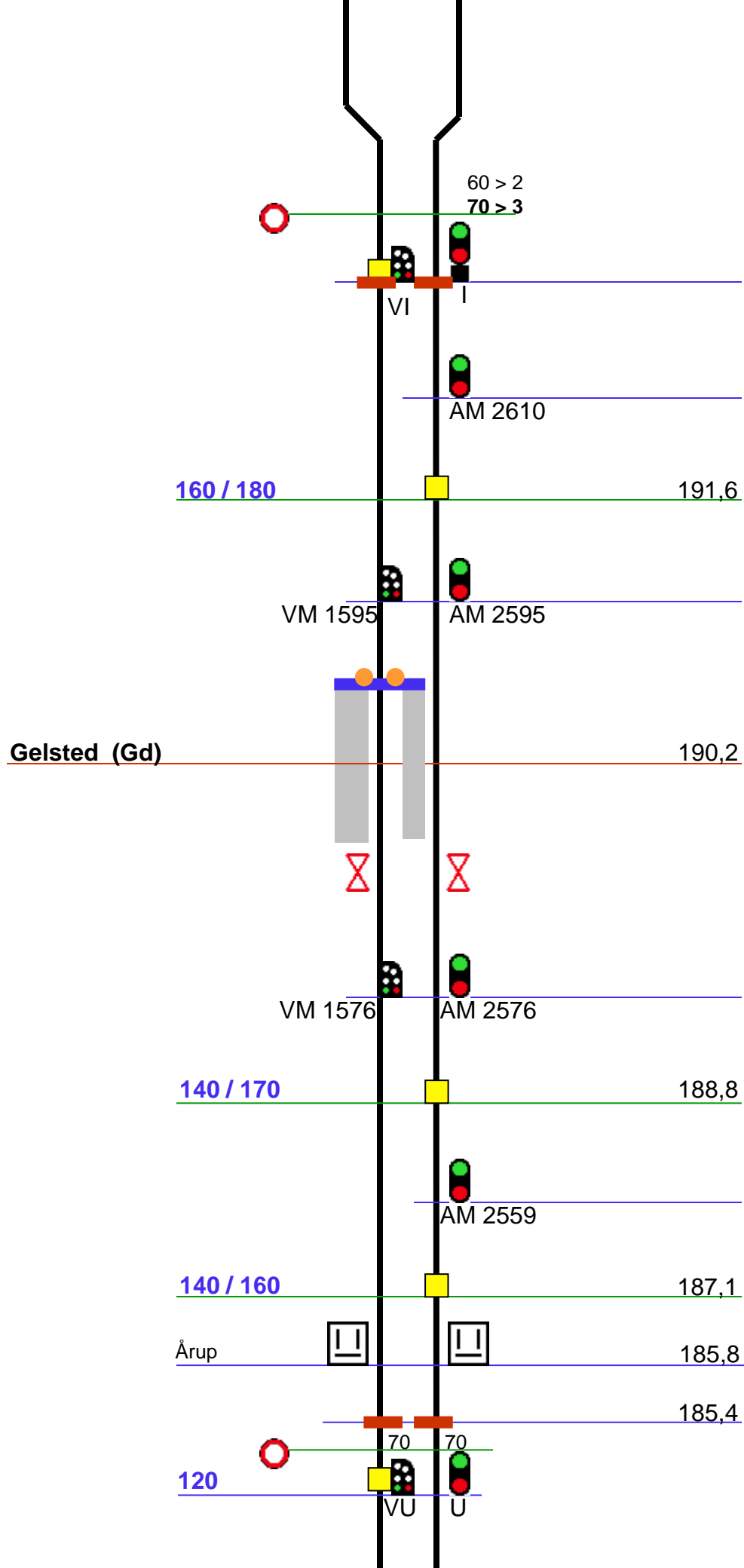

Linieblok
FC Fa

FC Fa

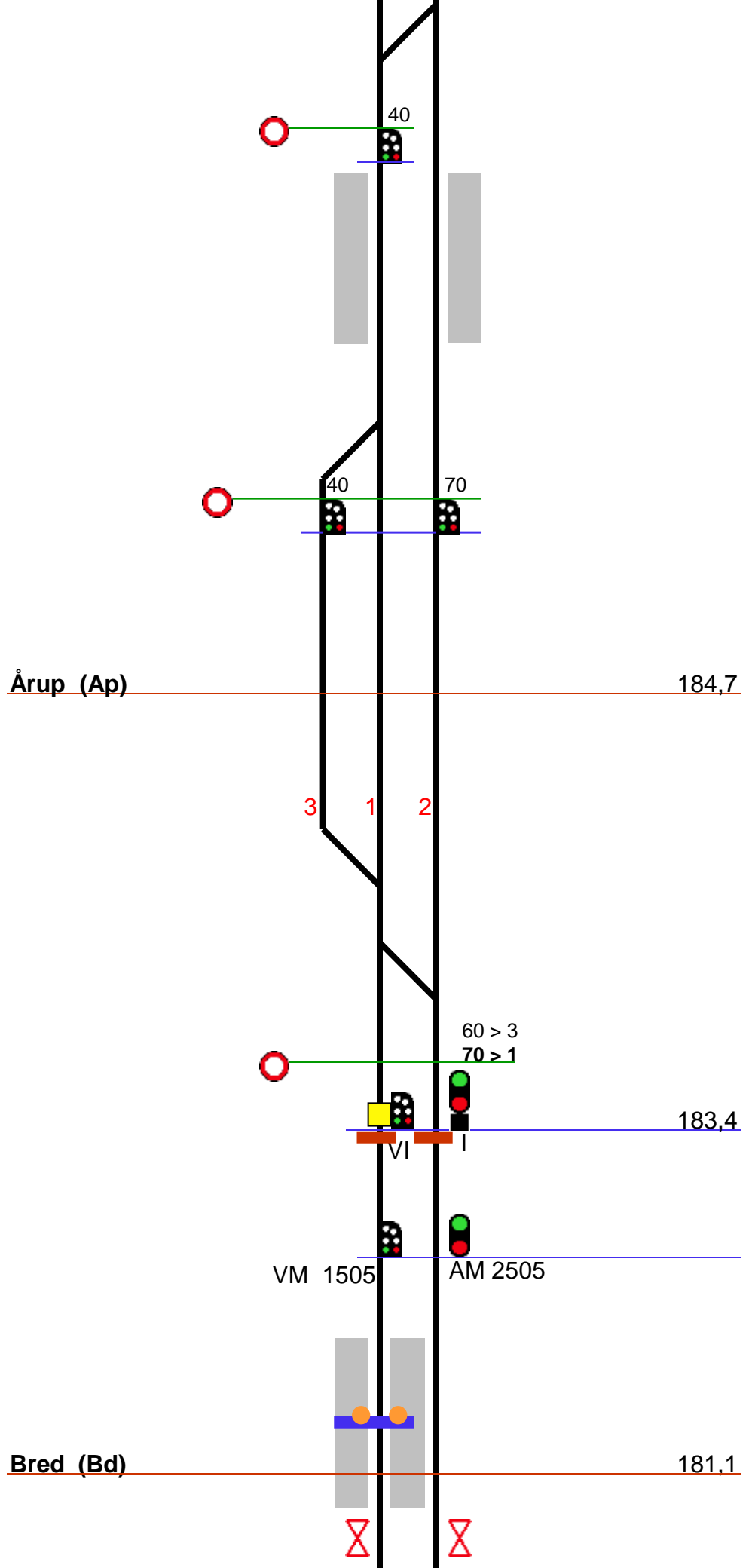

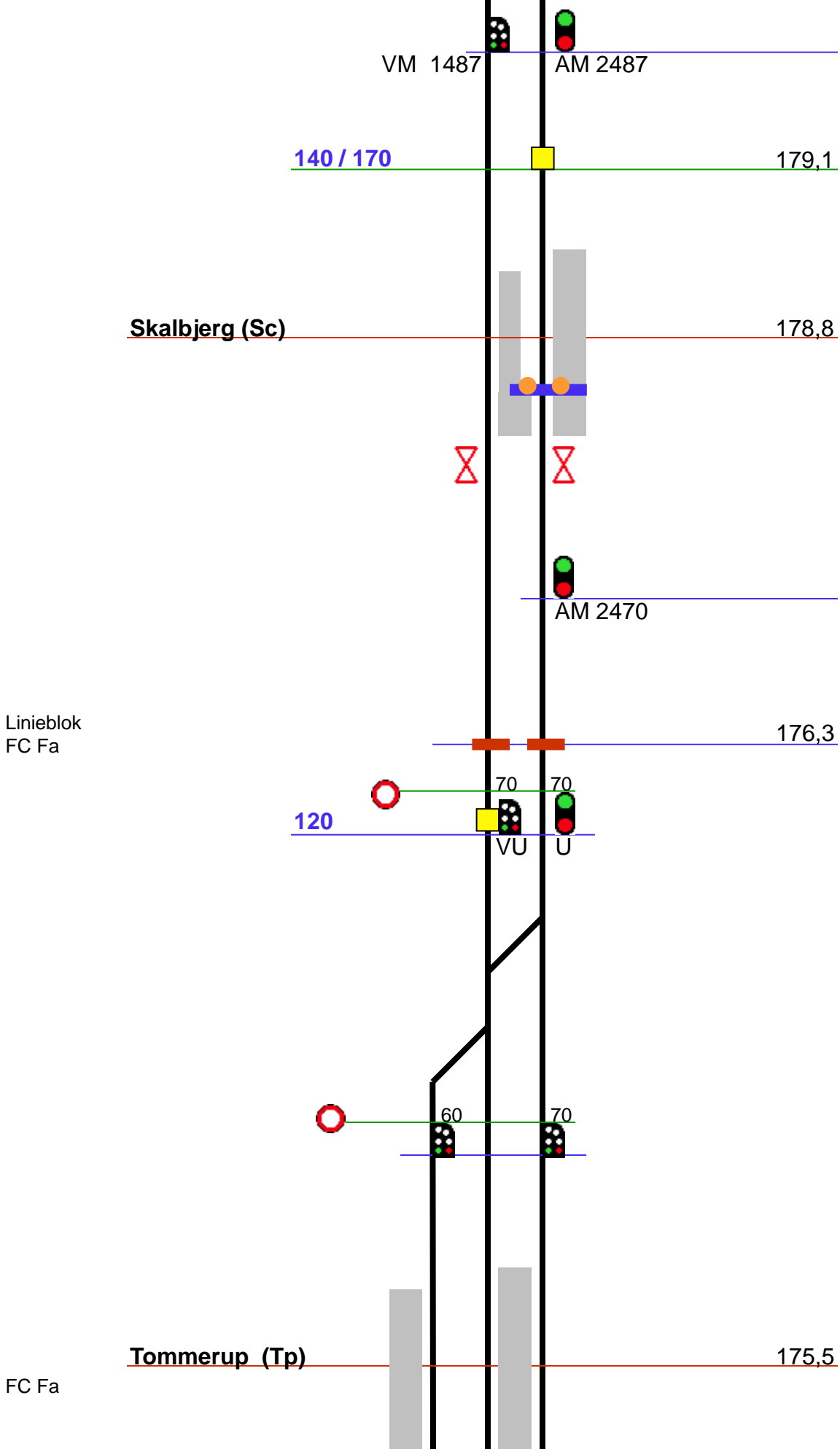

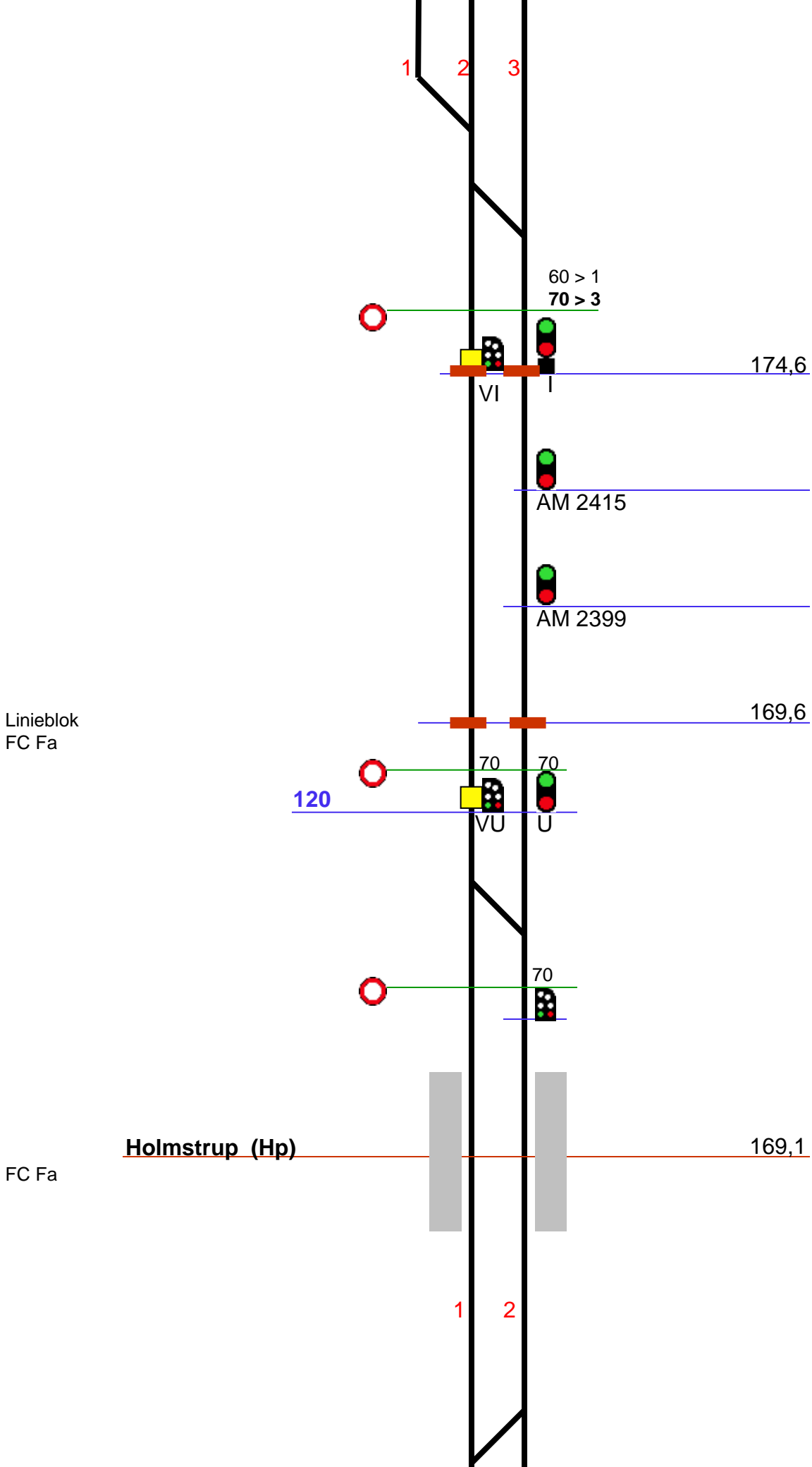

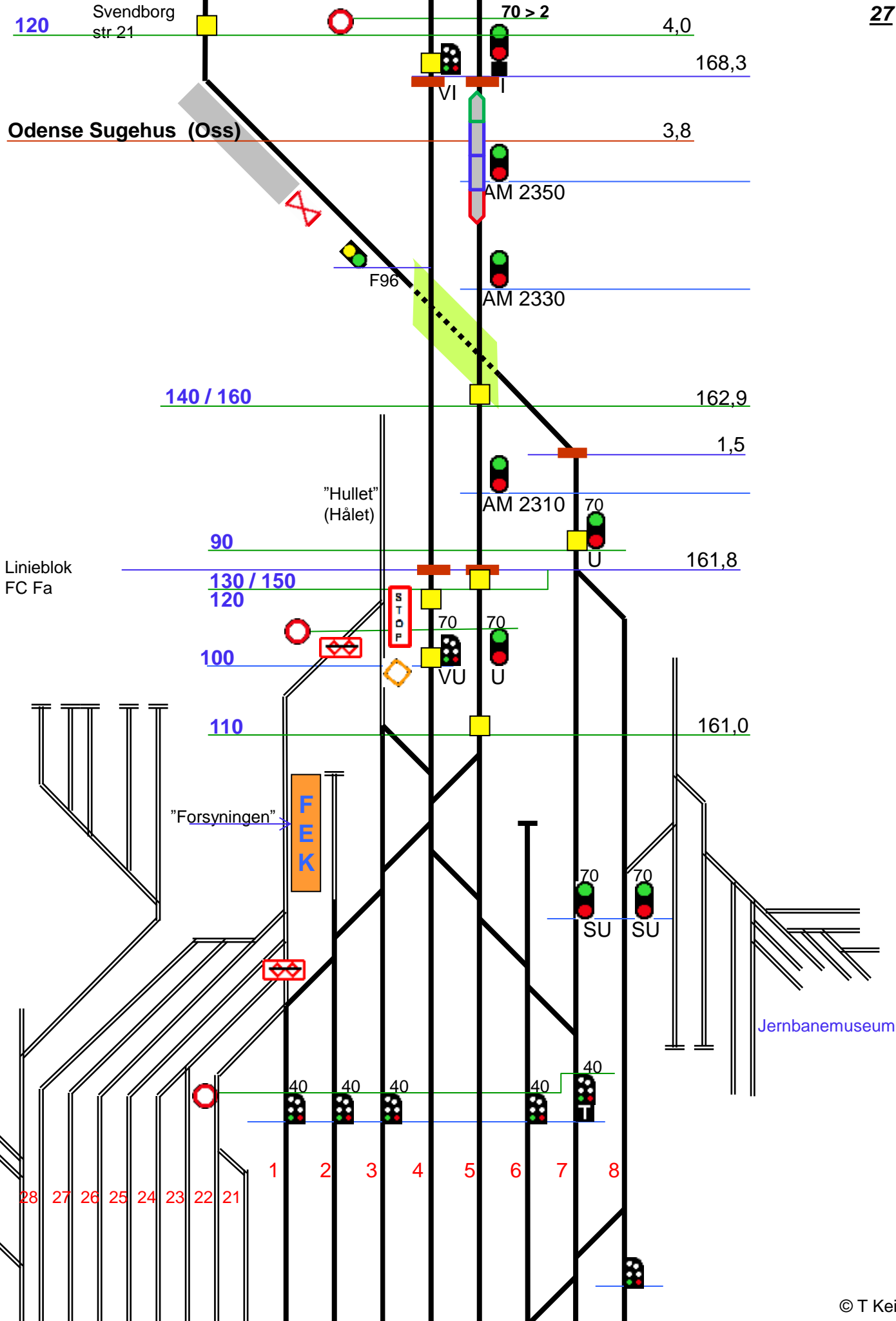

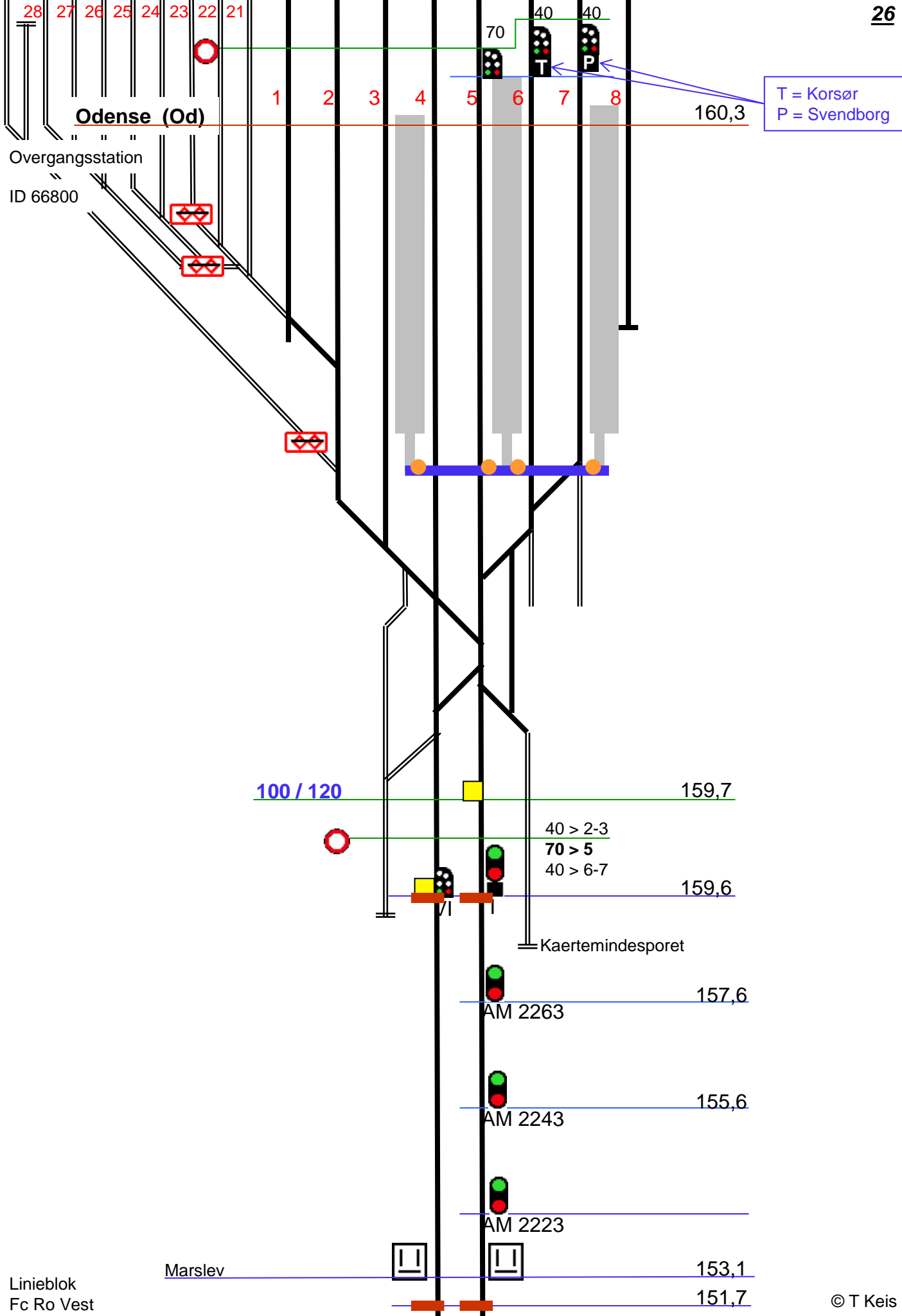

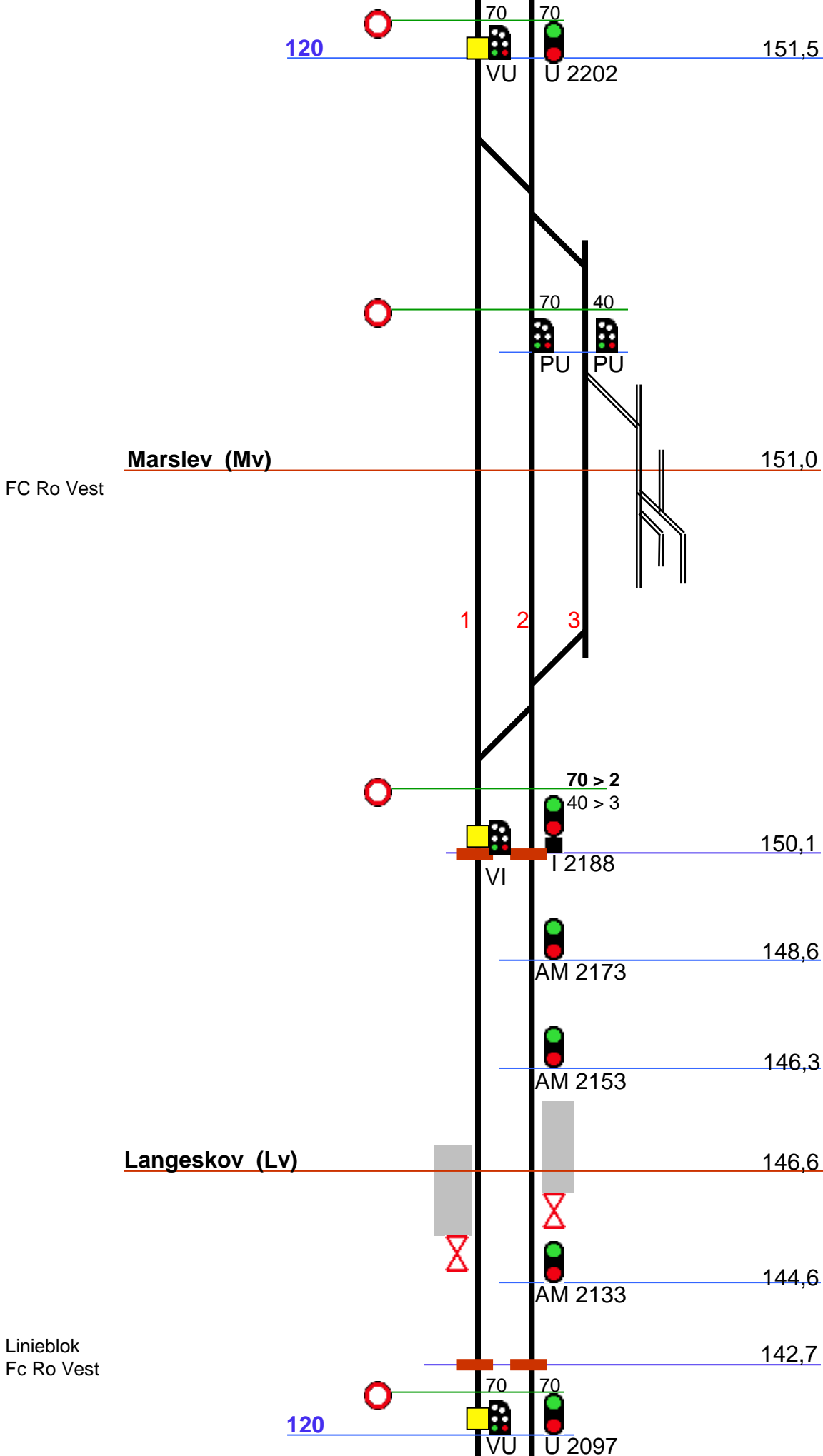

FC Ro Vest

Linieblok
Fc Ro Vest

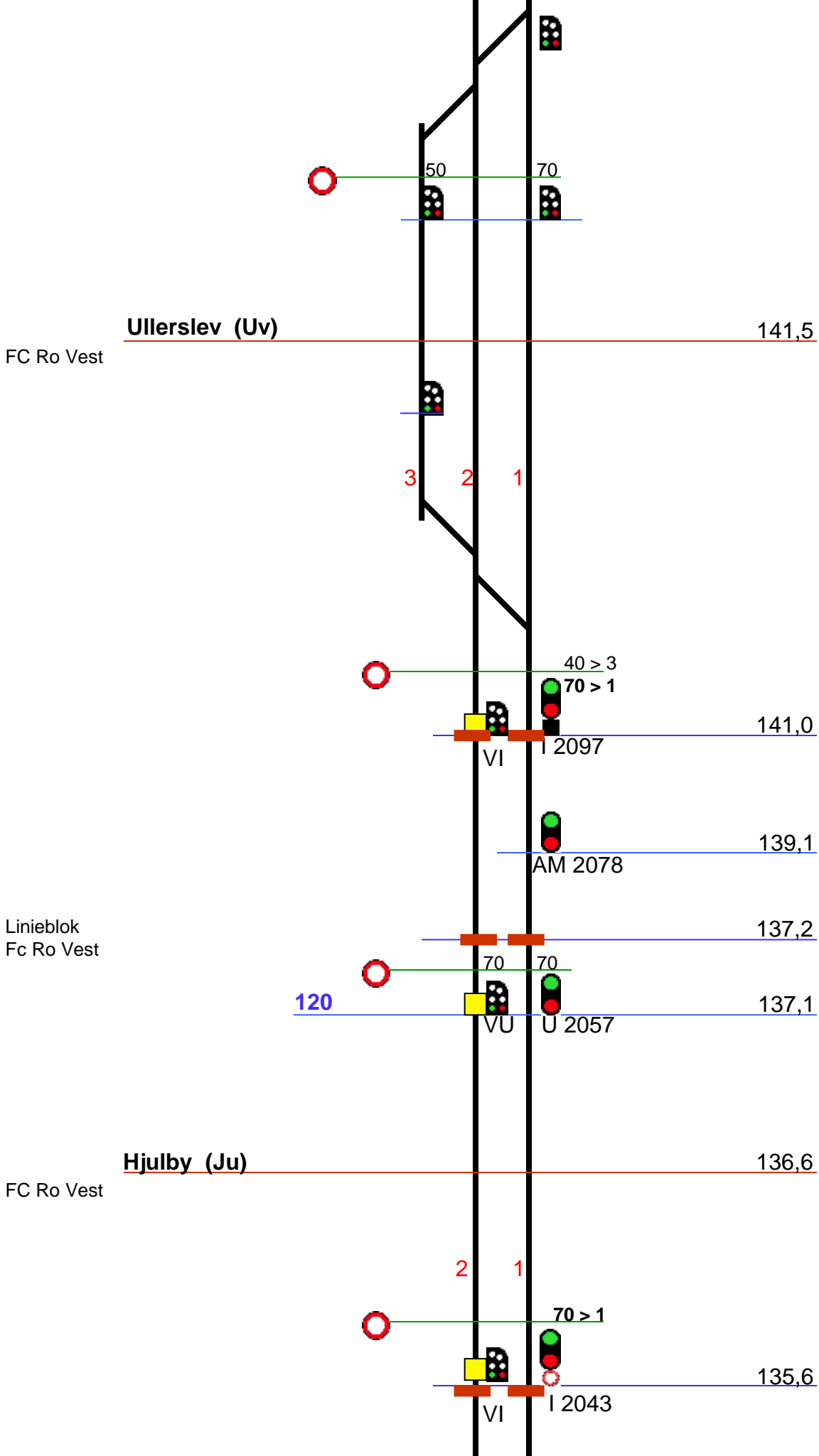

Linieblok
Fc Ro Vest

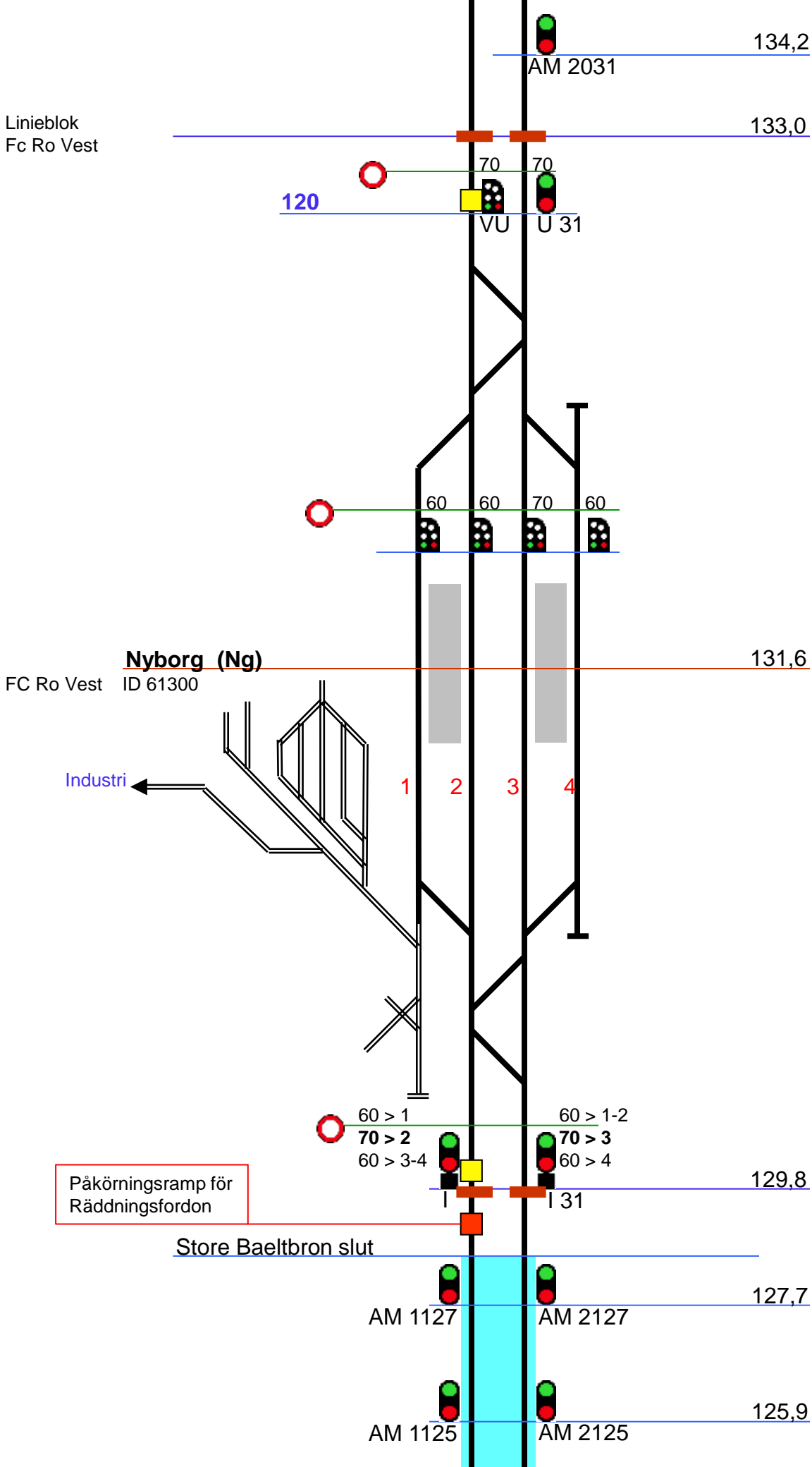

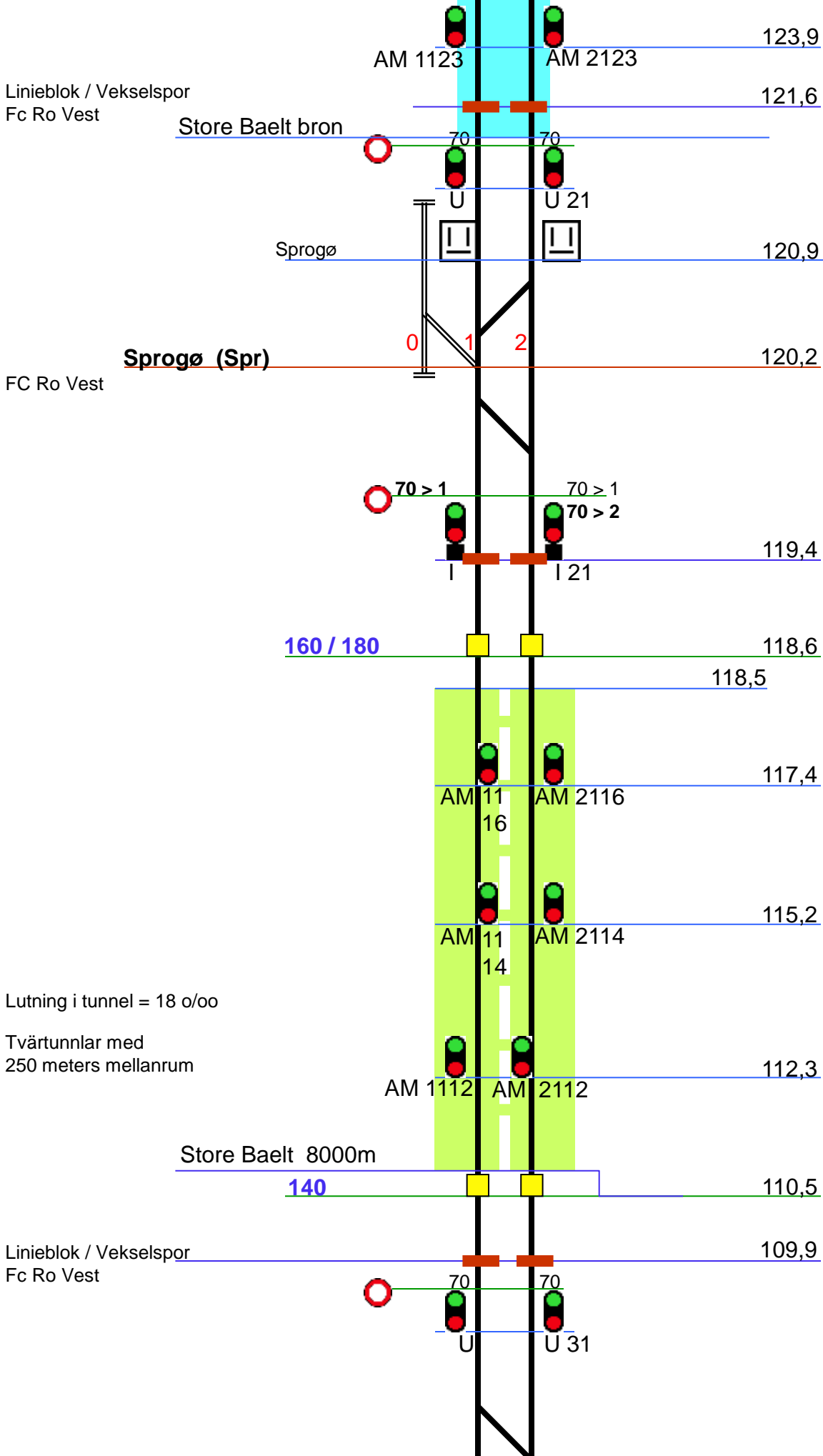

Lutning i tunnel = 18 o/oo
Tvärtunnlar med
250 meters mellanrum

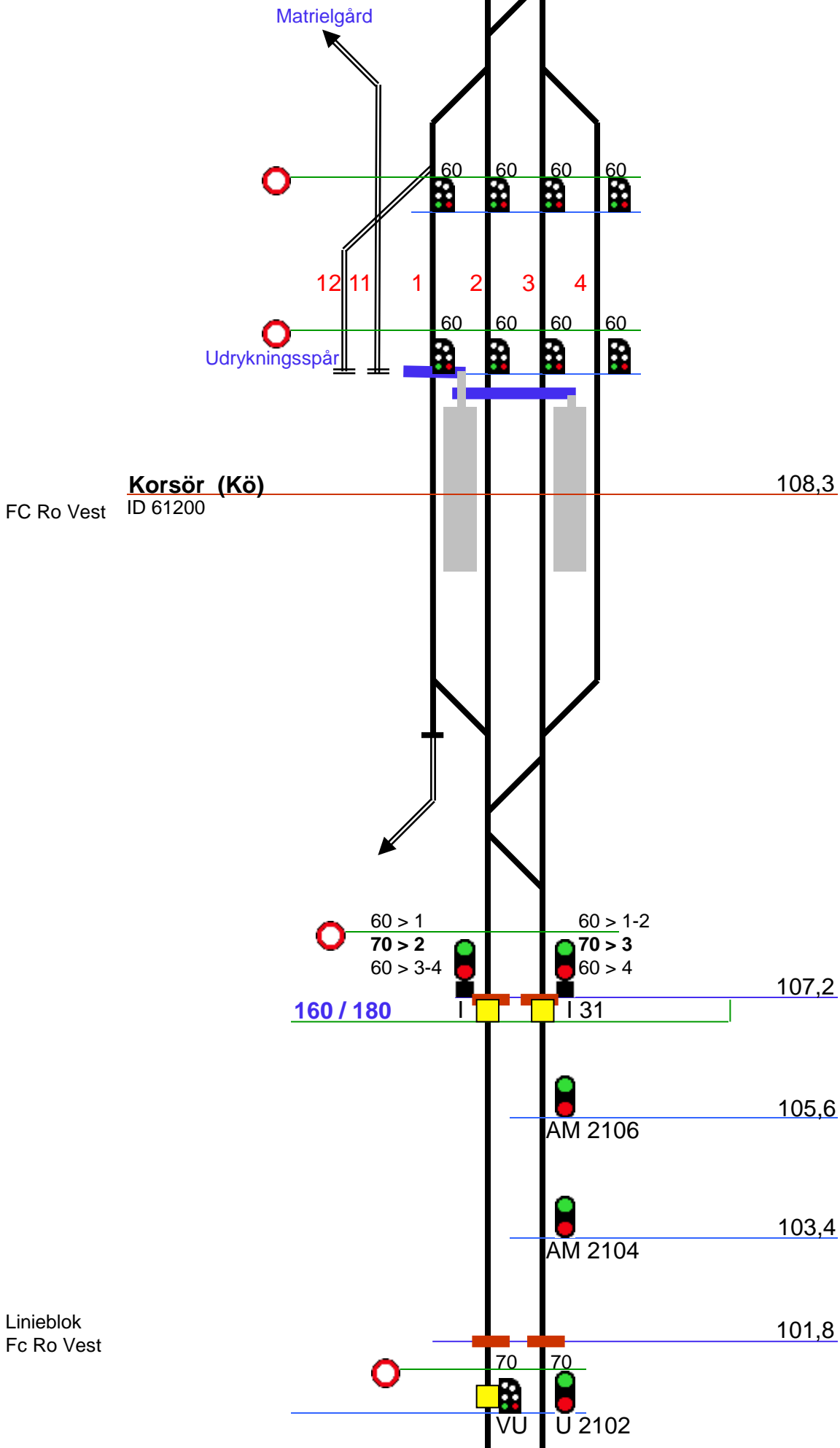

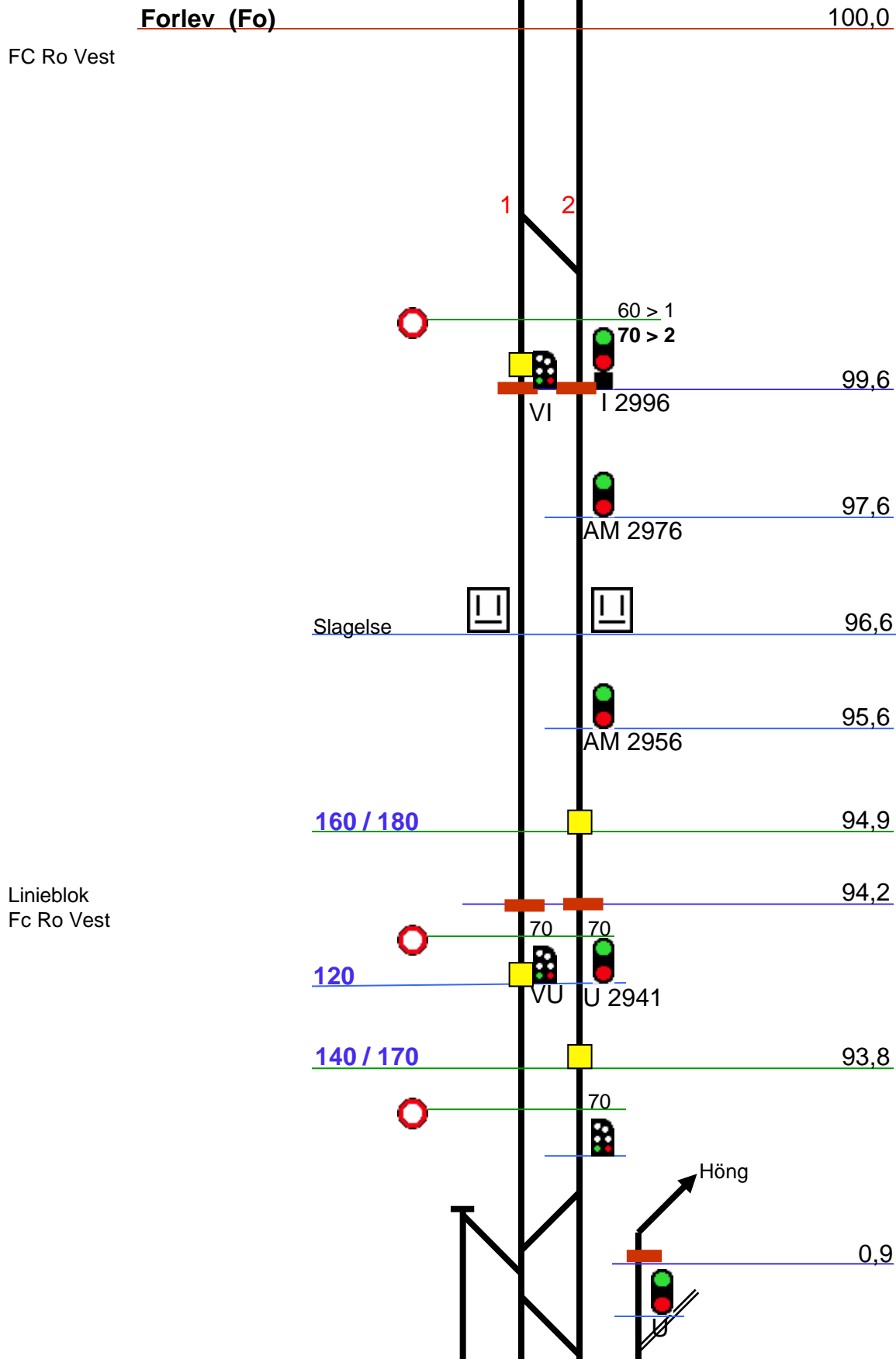

Slagelse (Sg)
Overgangsstation
FC Ro Vest ID 61051

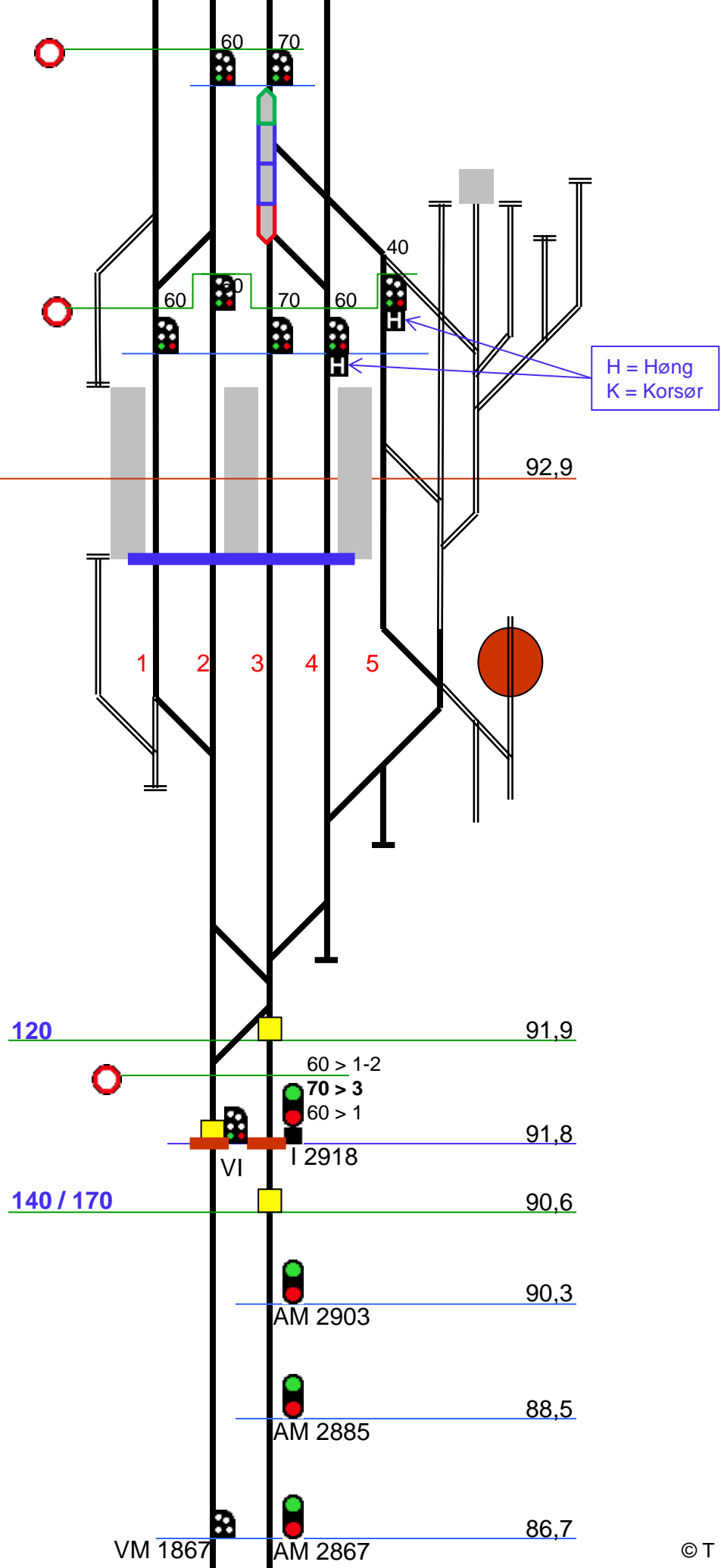

Linieblok
Fc Ro Vest

FC Ro Vest

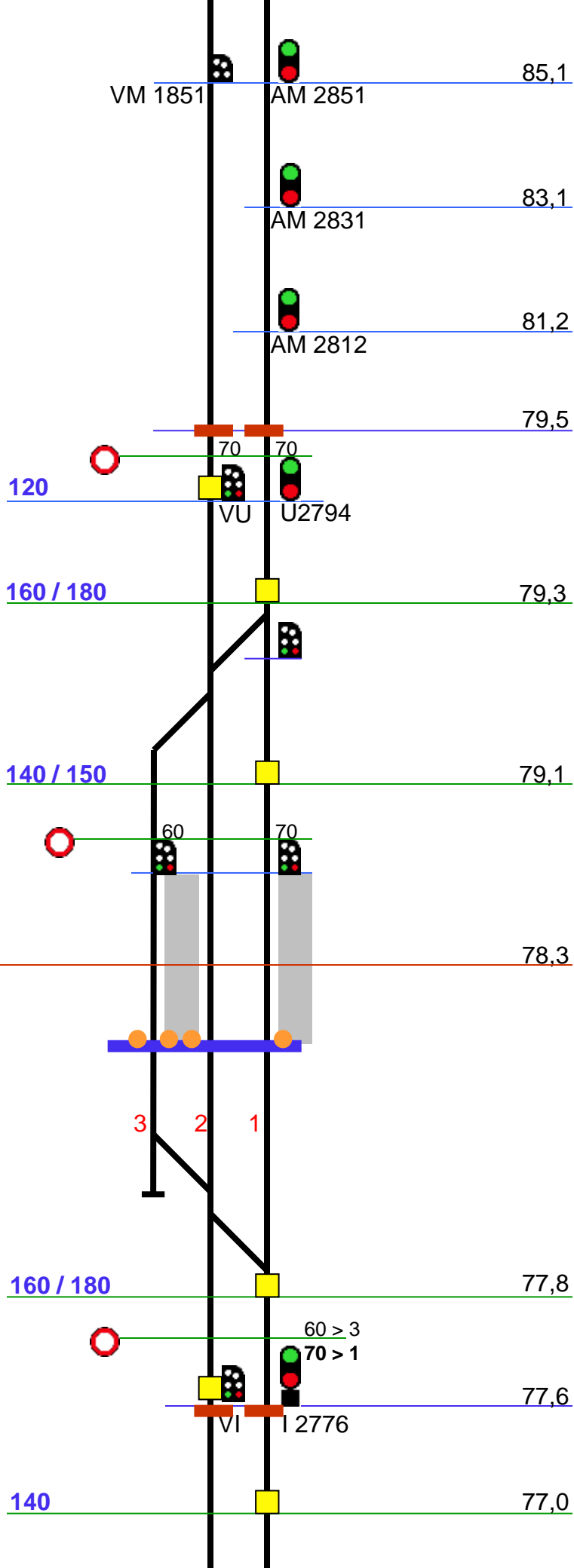

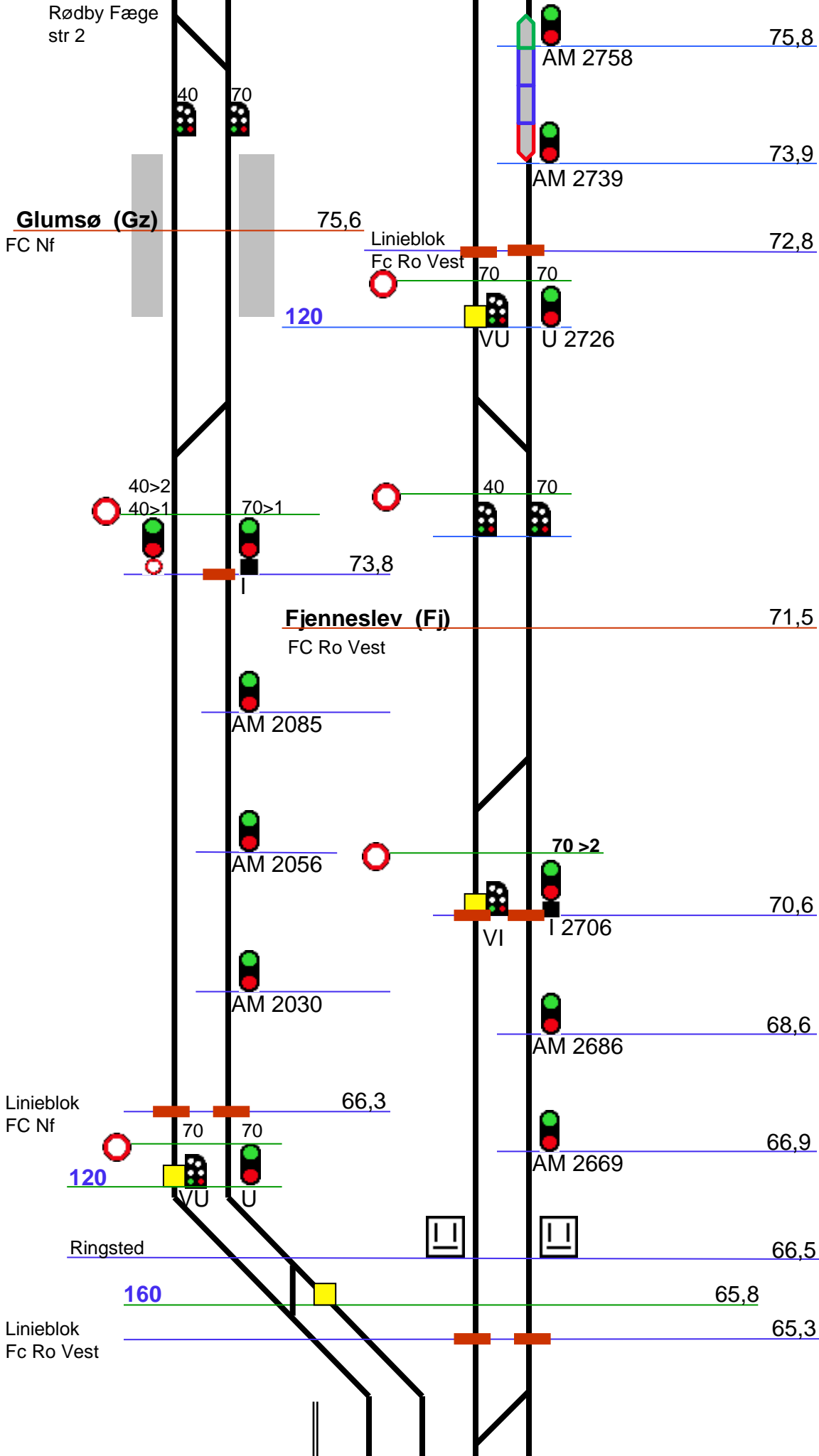

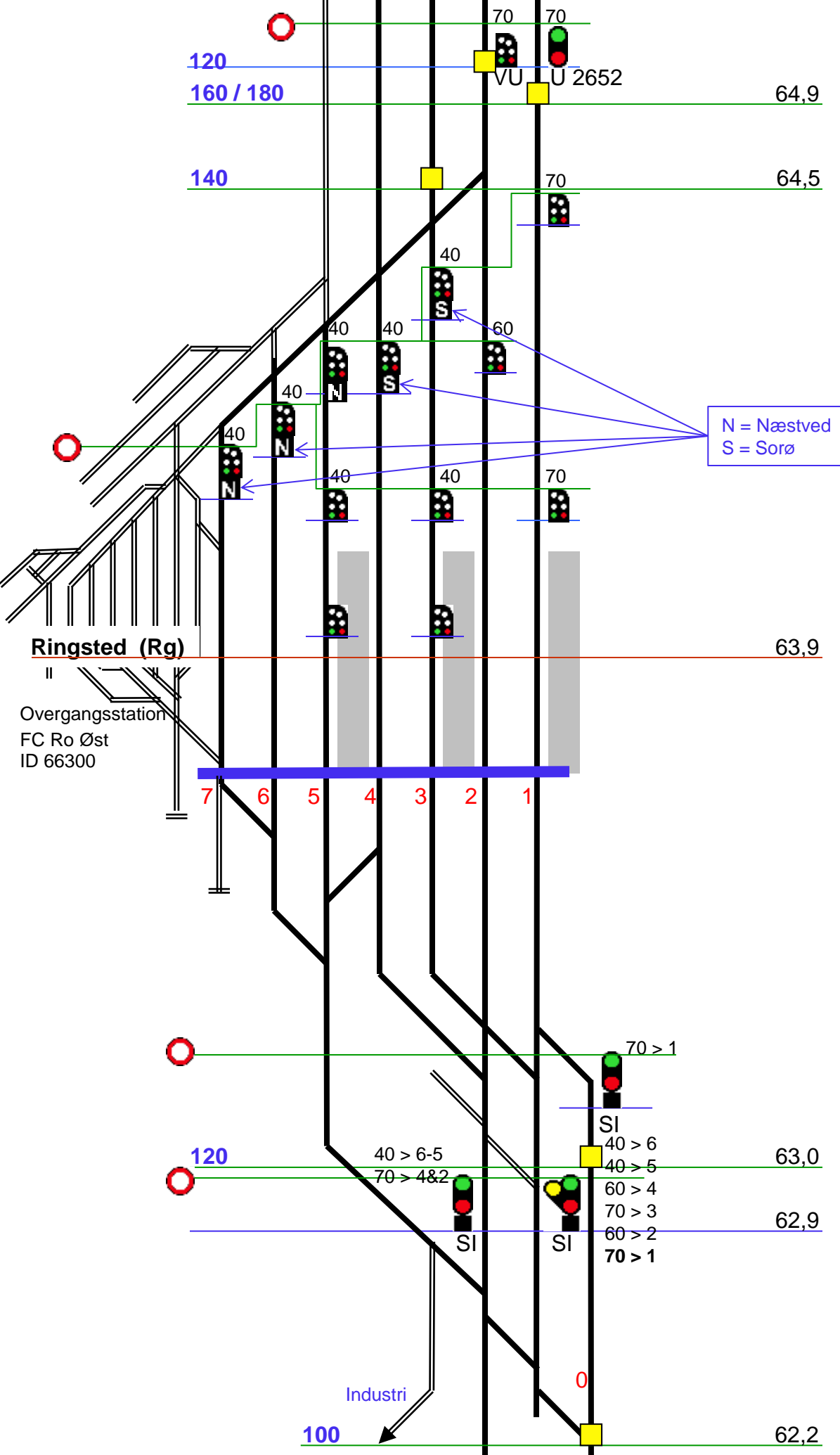

N = Næstved
S = Sorø

Linieblok
Fc Ro Øst

FC Ro Øst

Linieblok
Fc Ro Øst

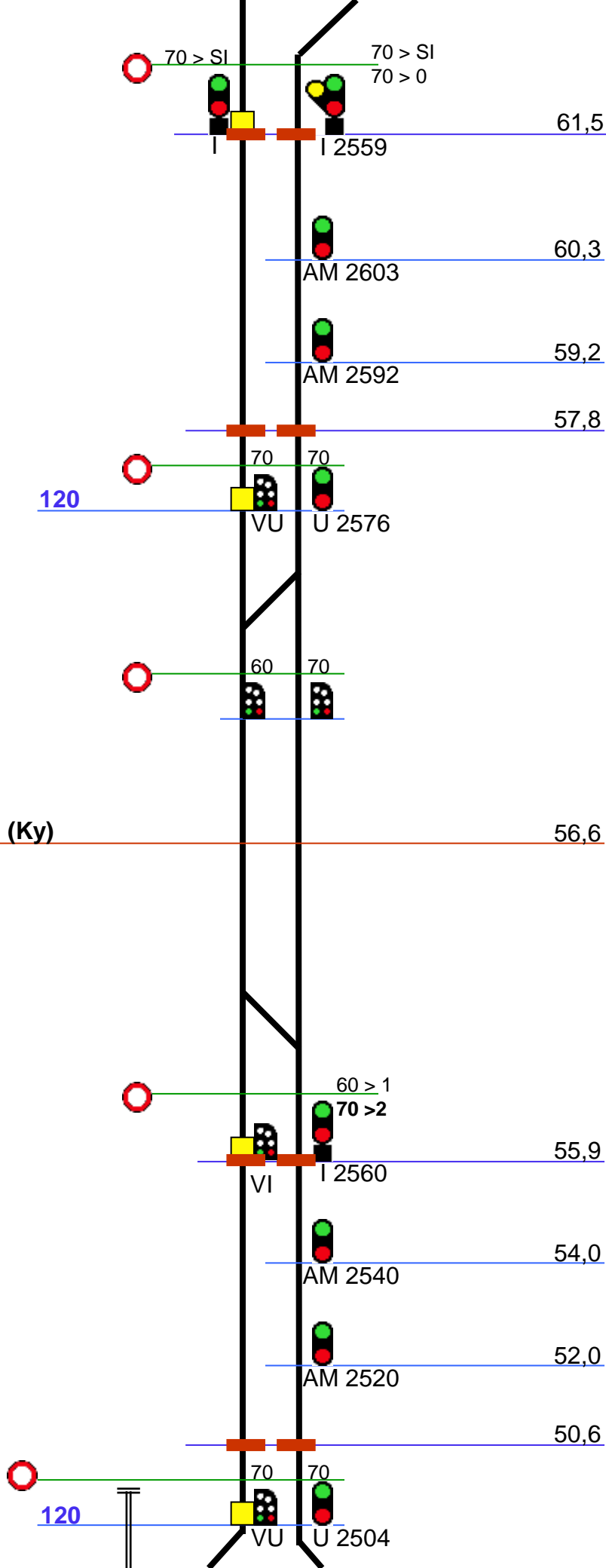

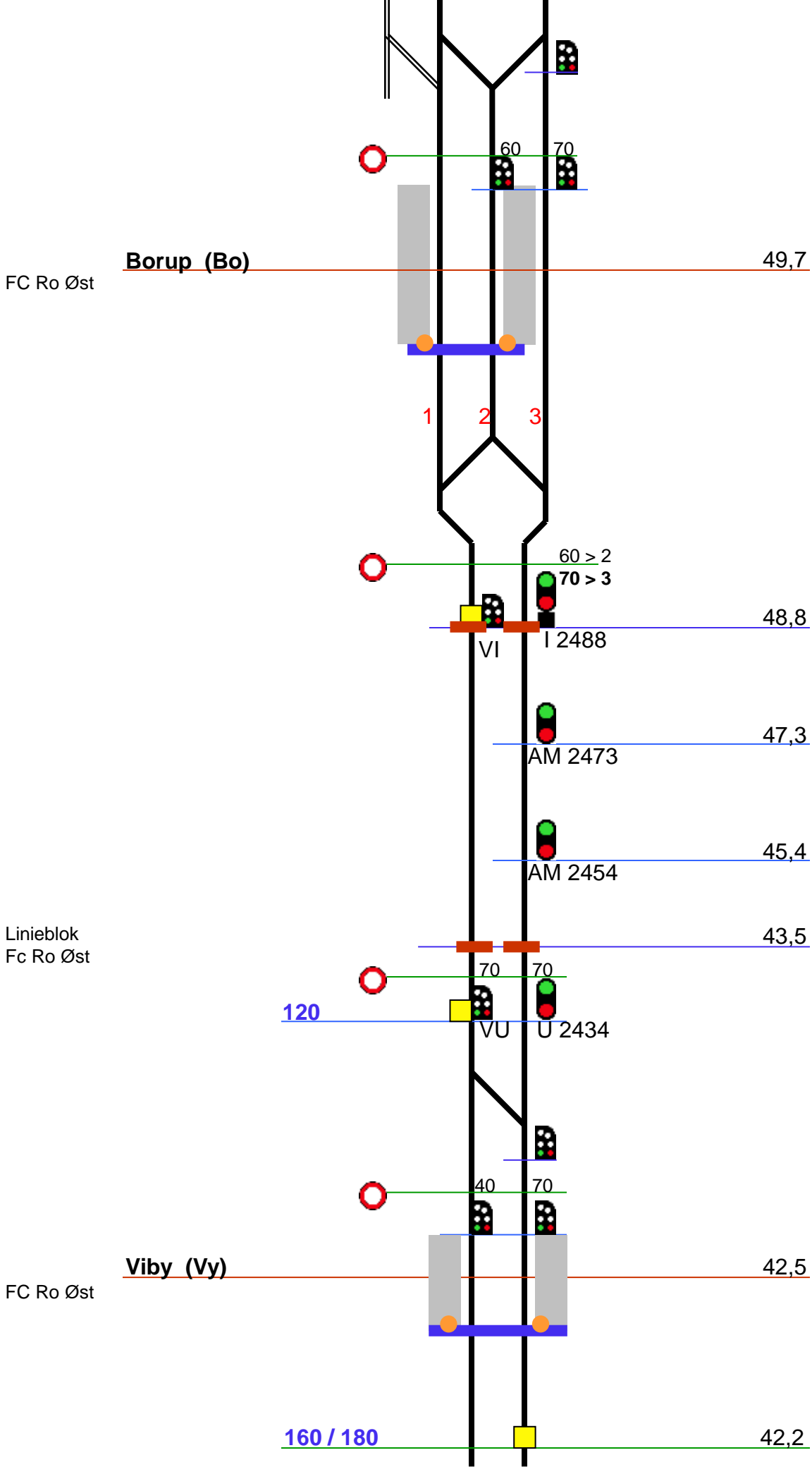

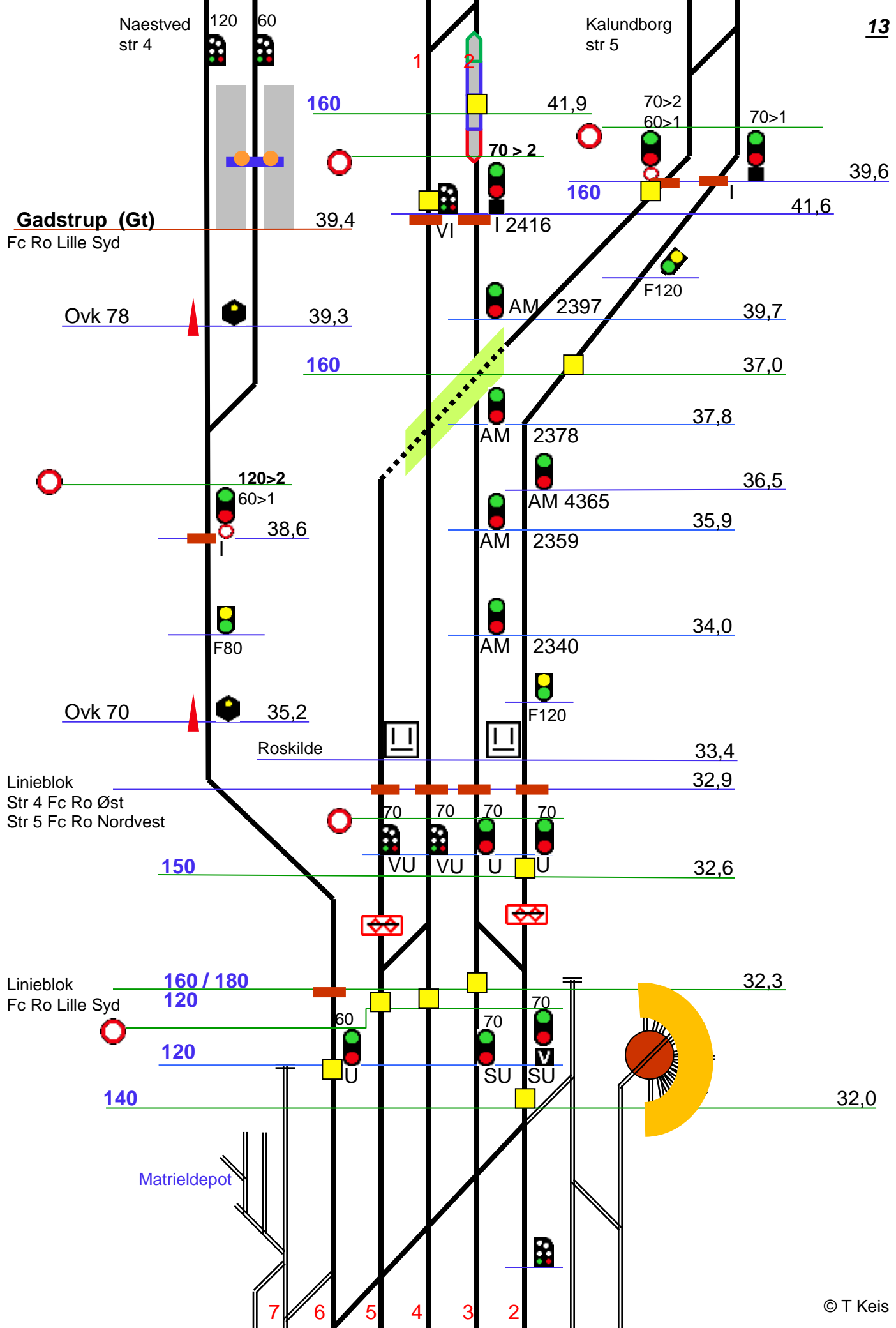

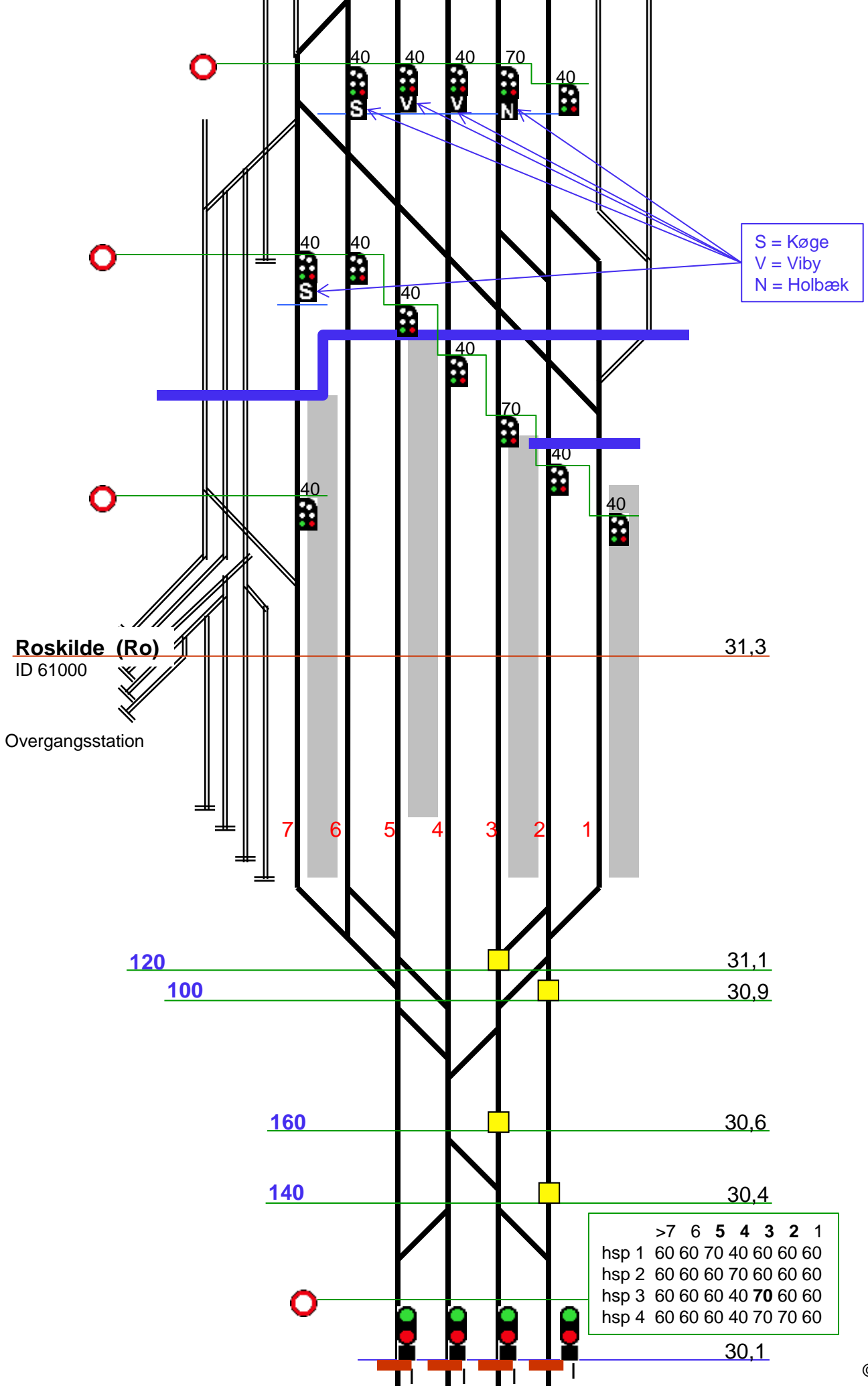

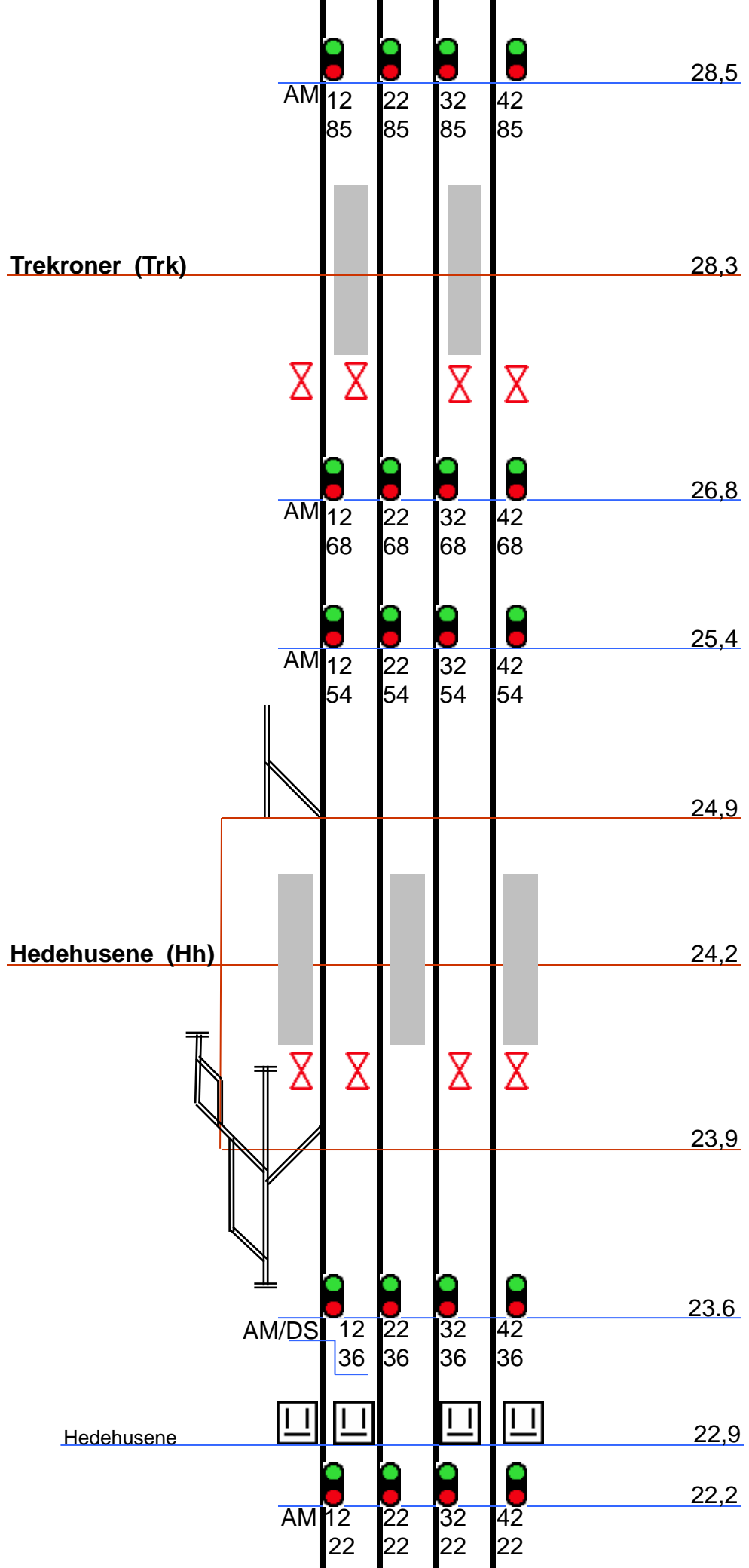

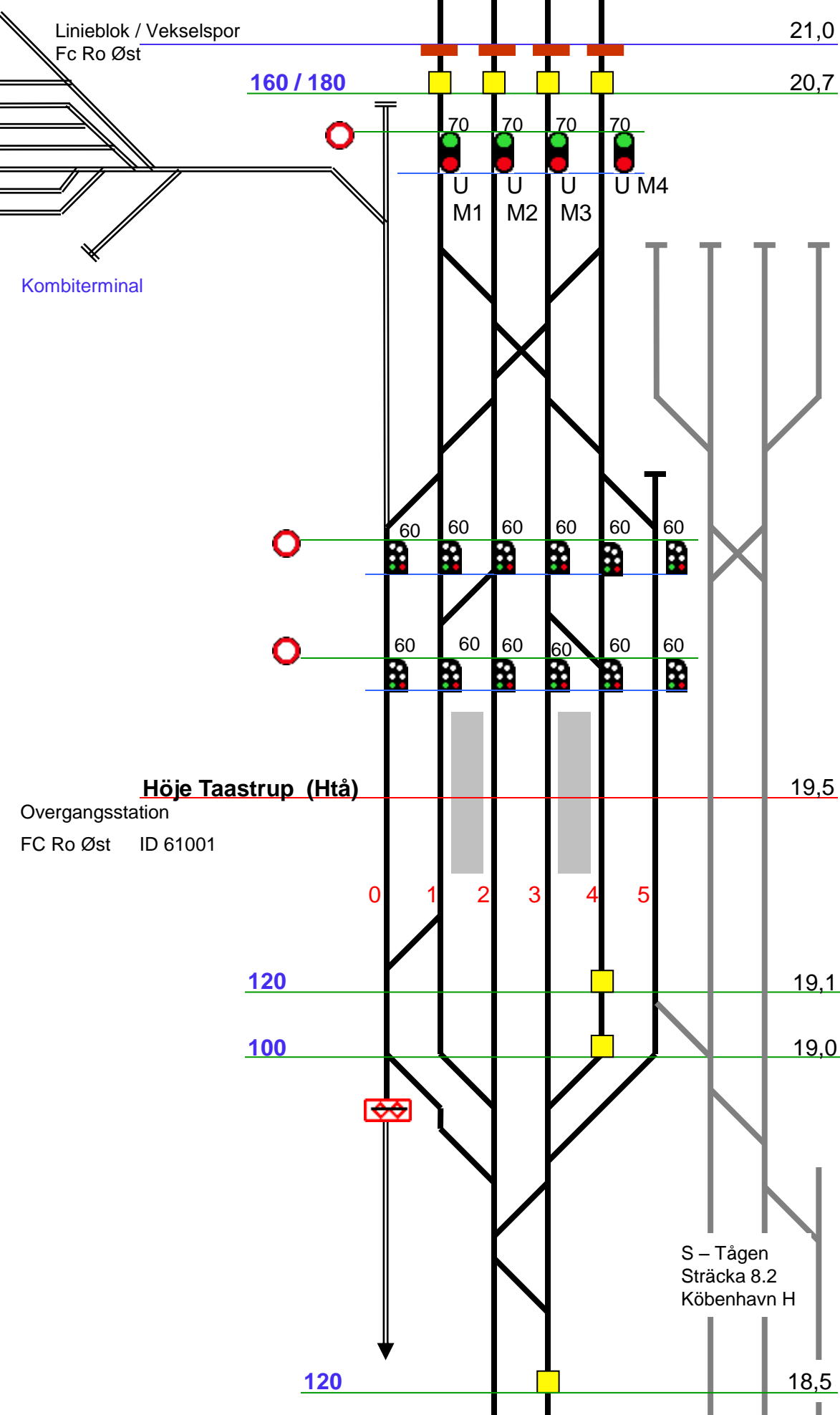

Linieblok
Fc Kh

FC Kh

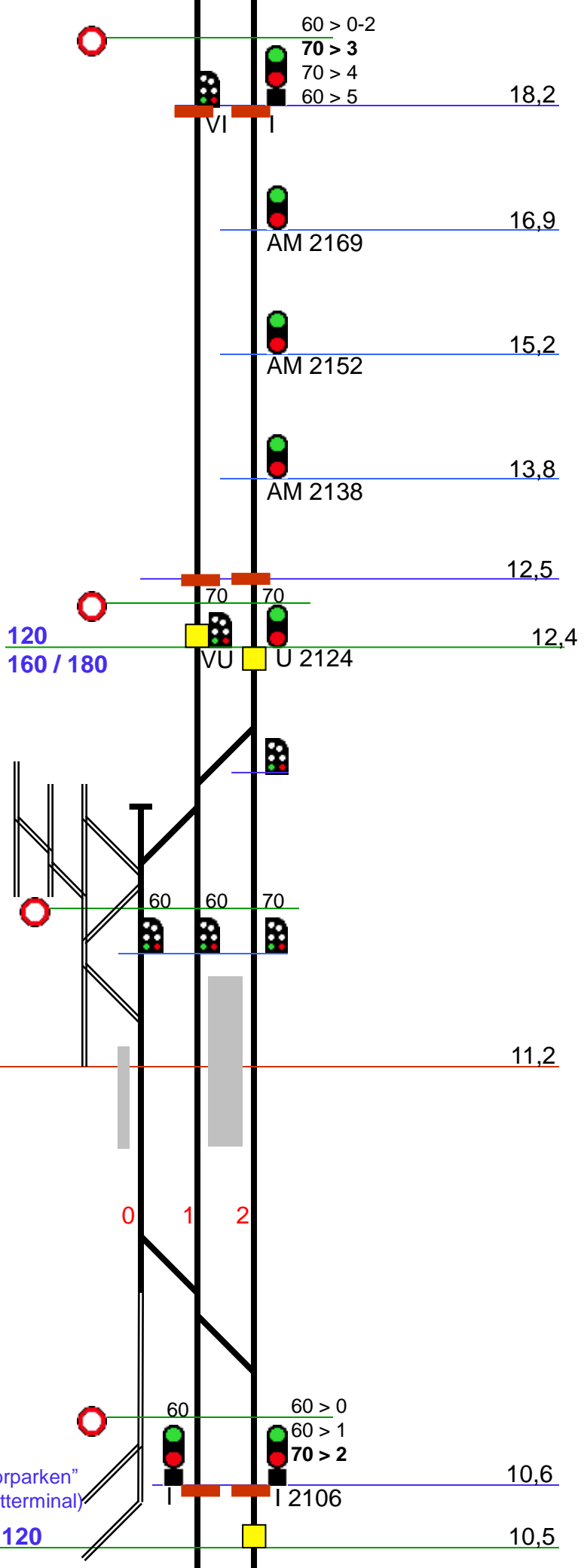

Linieblok
Fc Kh

FC Kh

Linieblok
Fc Kh

0 1 2

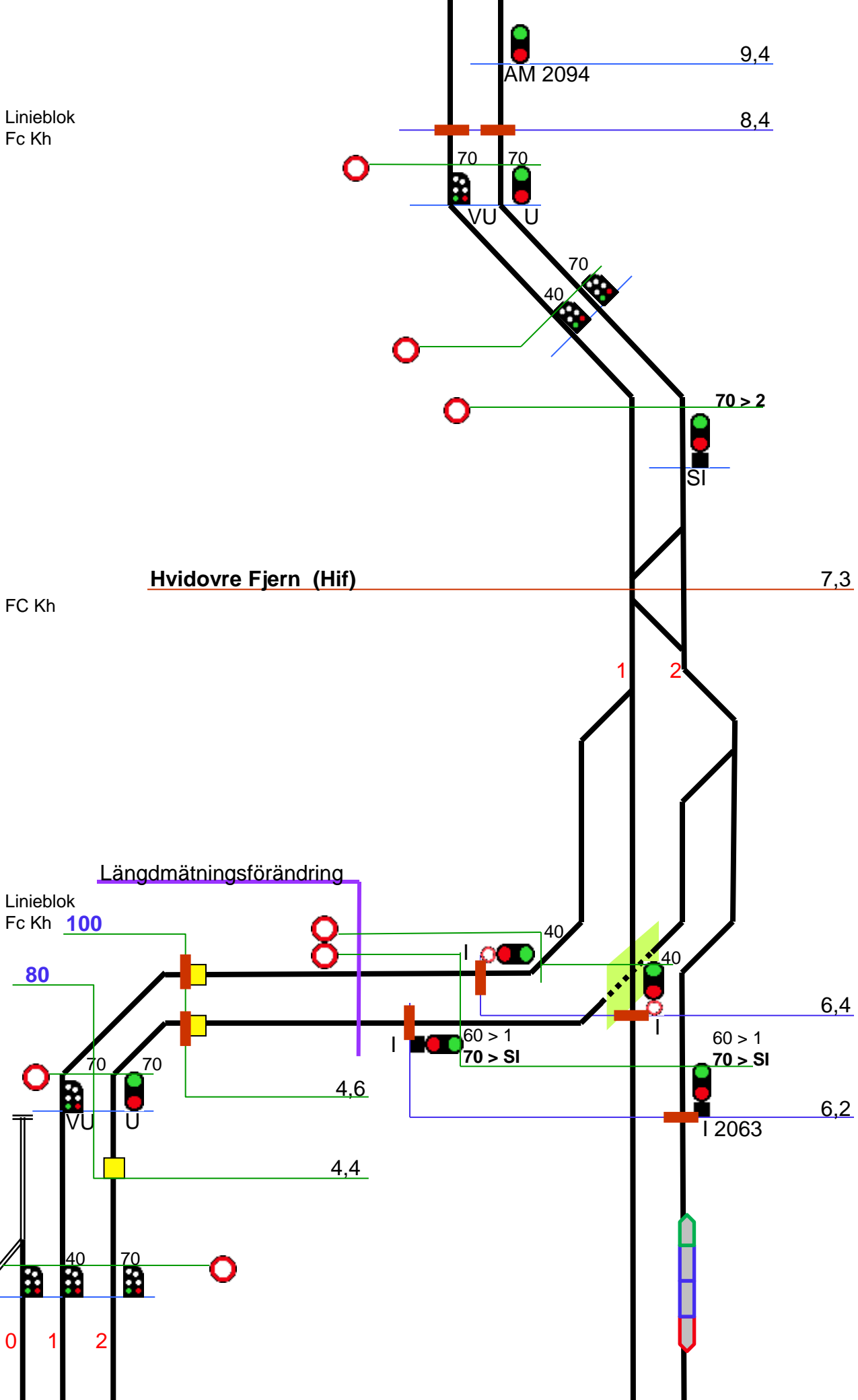

Vigerslev (lg) Fjern 0,0
FC Kh

Hvidovre Fjern 5,7

40 > 0
40 > 1
70 > 2

S - Tågen
Sträcka 8.6
Hellerup

5,2
AM 2052

100

4,2

160 / 180
4,2
AM 2042

Kalvebod
strækning 11

Valby (Val) 3,9

40
70 > SI
40 > HI
2,4

80
2,3

Linieblok
Fc Kh 1,2

60
60
1,1

København G 0.0

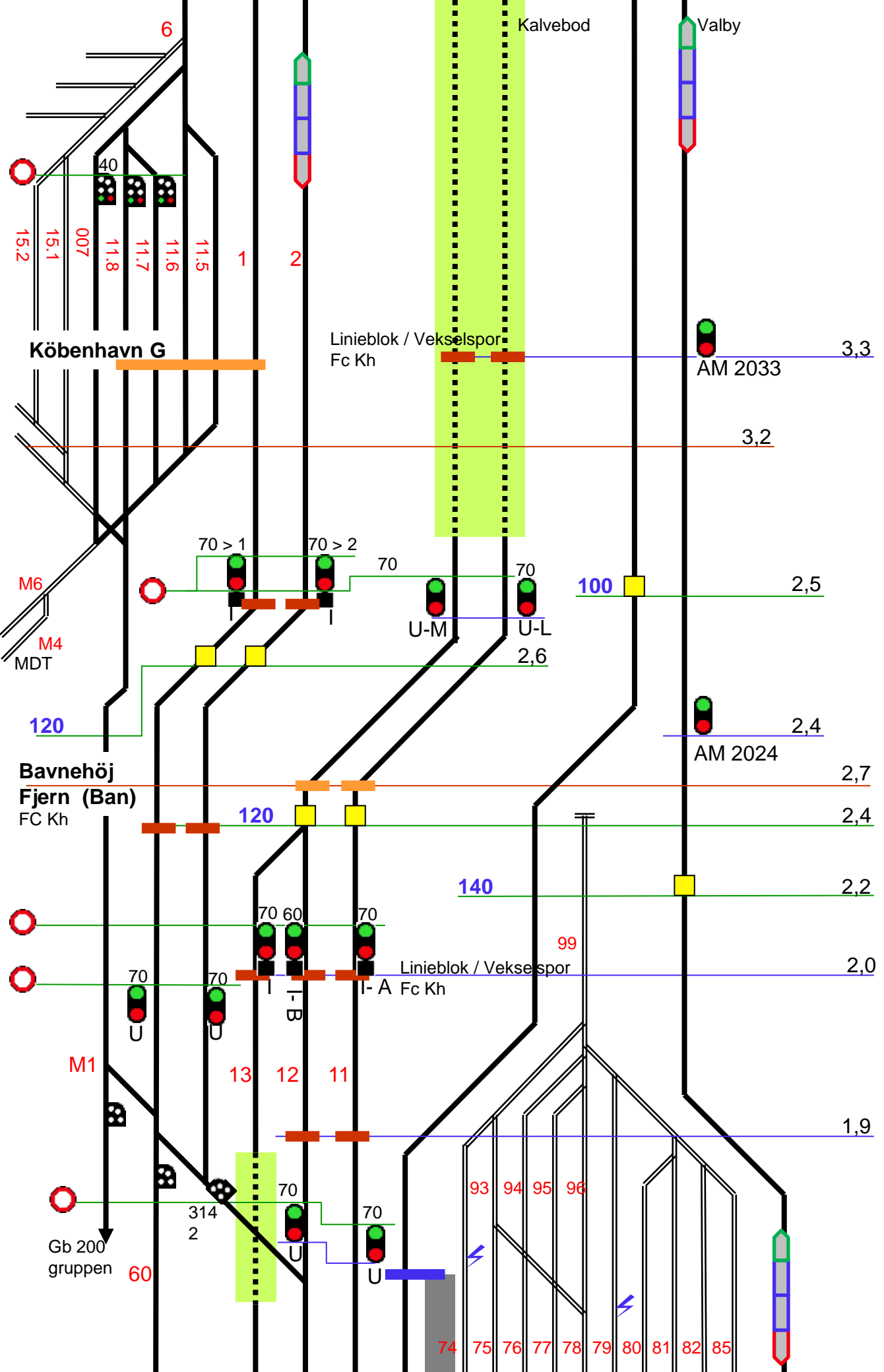

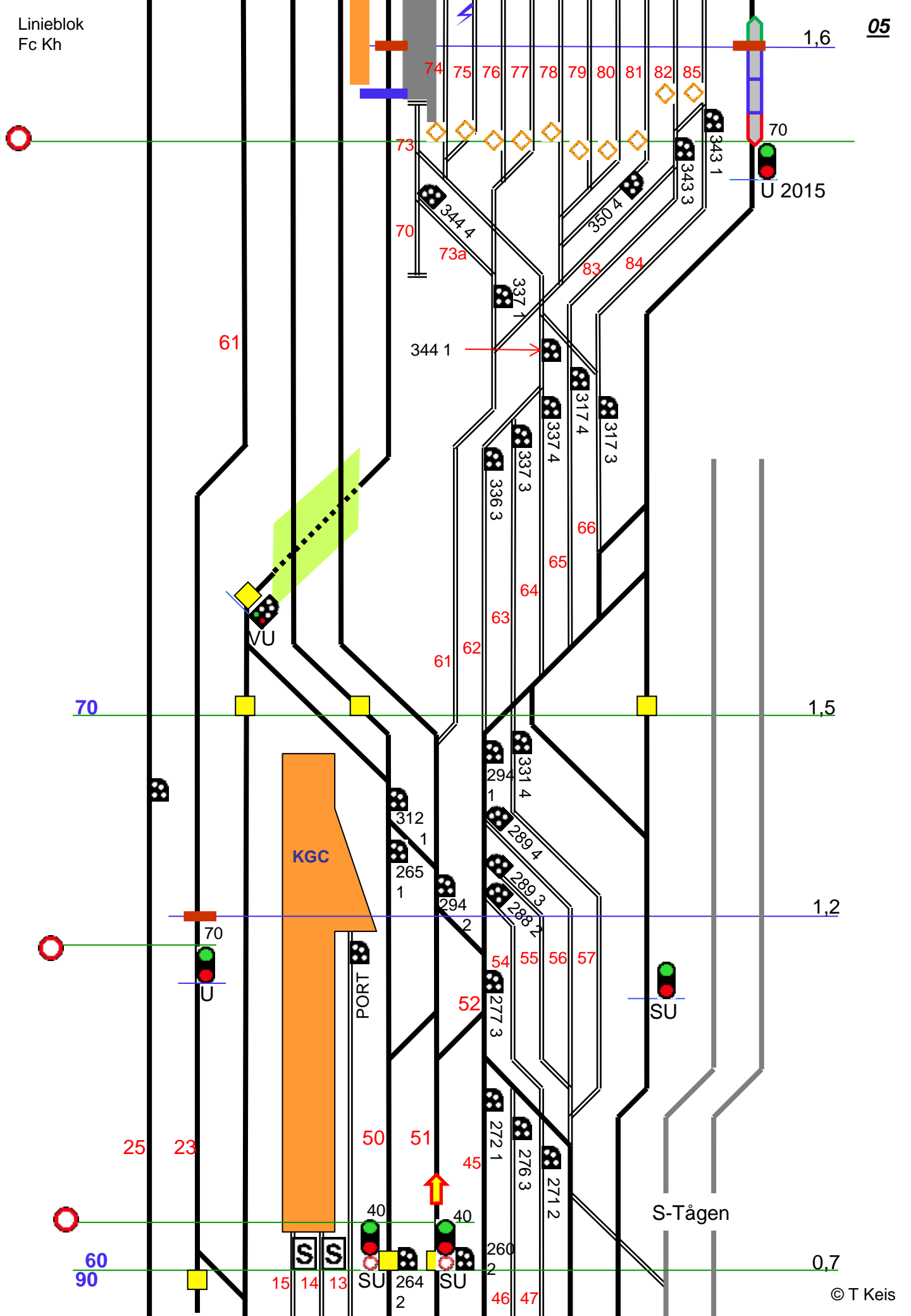

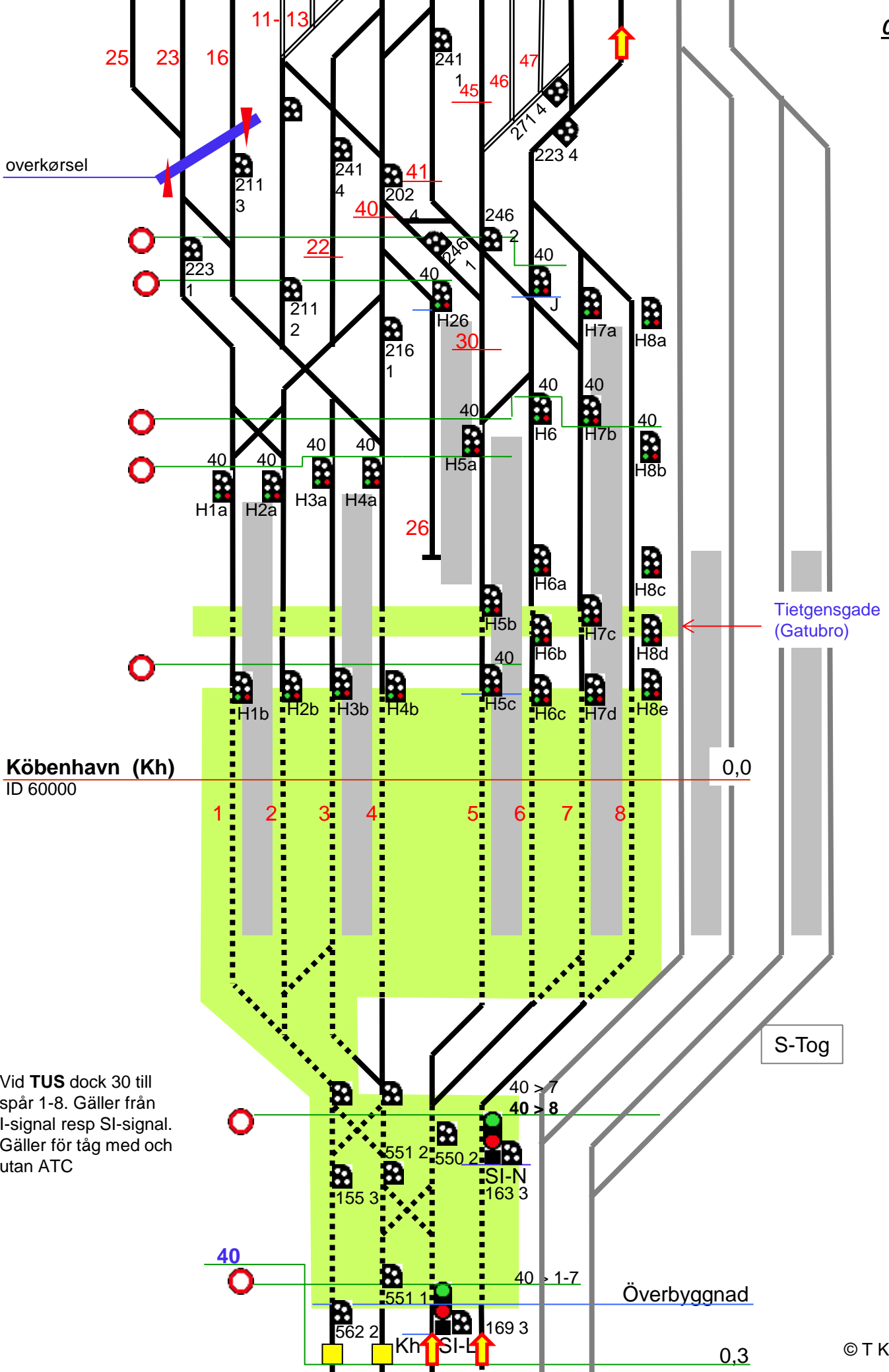

overkørsel

Tietgensgade (Gatubro)

Köbenhavn (Kh)
ID 60000

S-Tog

Vid TUS dock 30 till spår 1-8. Gäller från I-signal resp SI-signal. Gäller för tåg med och utan ATC

Överbyggnad

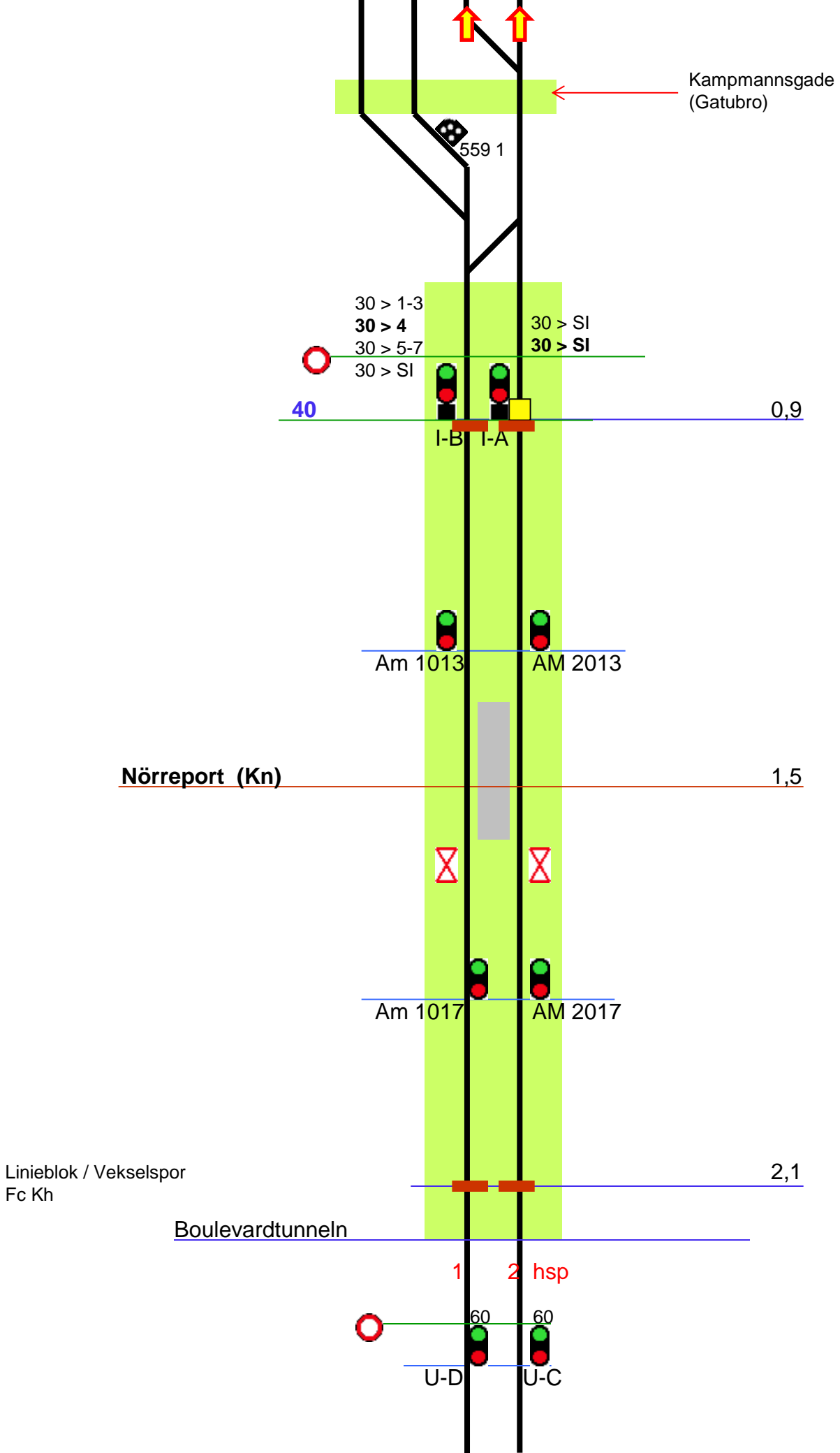

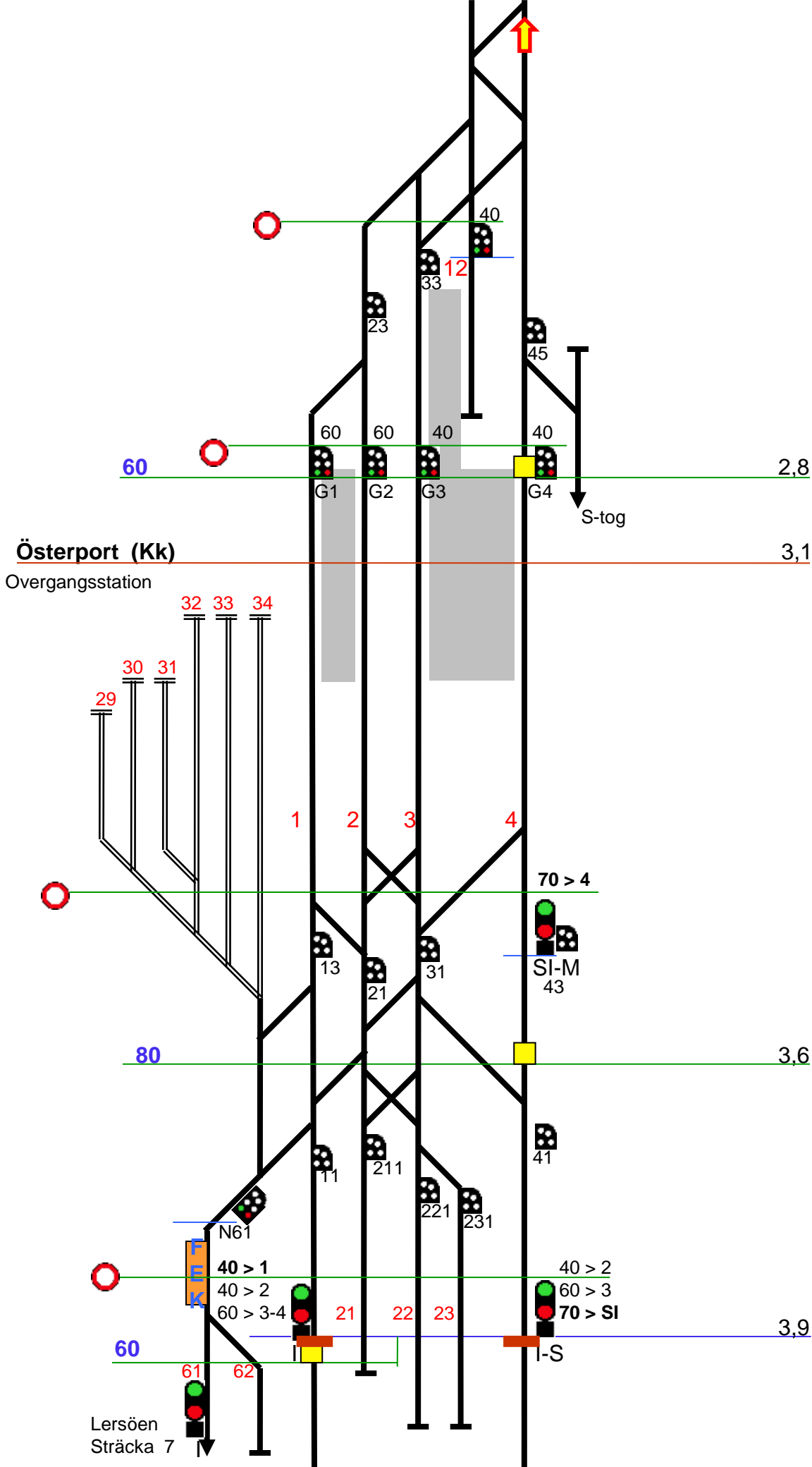

Österport (Kk)

Övergångsstation

Lersöen
Sträcka 7

