

Linieblok
FC Ar

Langå
str 32

FC Ar

Hjerm (Hm)

Ovk 377

120

100

Linieblok
FC Ar

Ovk 361

120

Holstebro (Ho)

Overgangsstation
FC Hr
ID 67200

5

70

70

195,3

195,1

195,1

194,5

187,5

187,1

186,8

186,6

60>1
70>2

F80

70

U

70

60

60

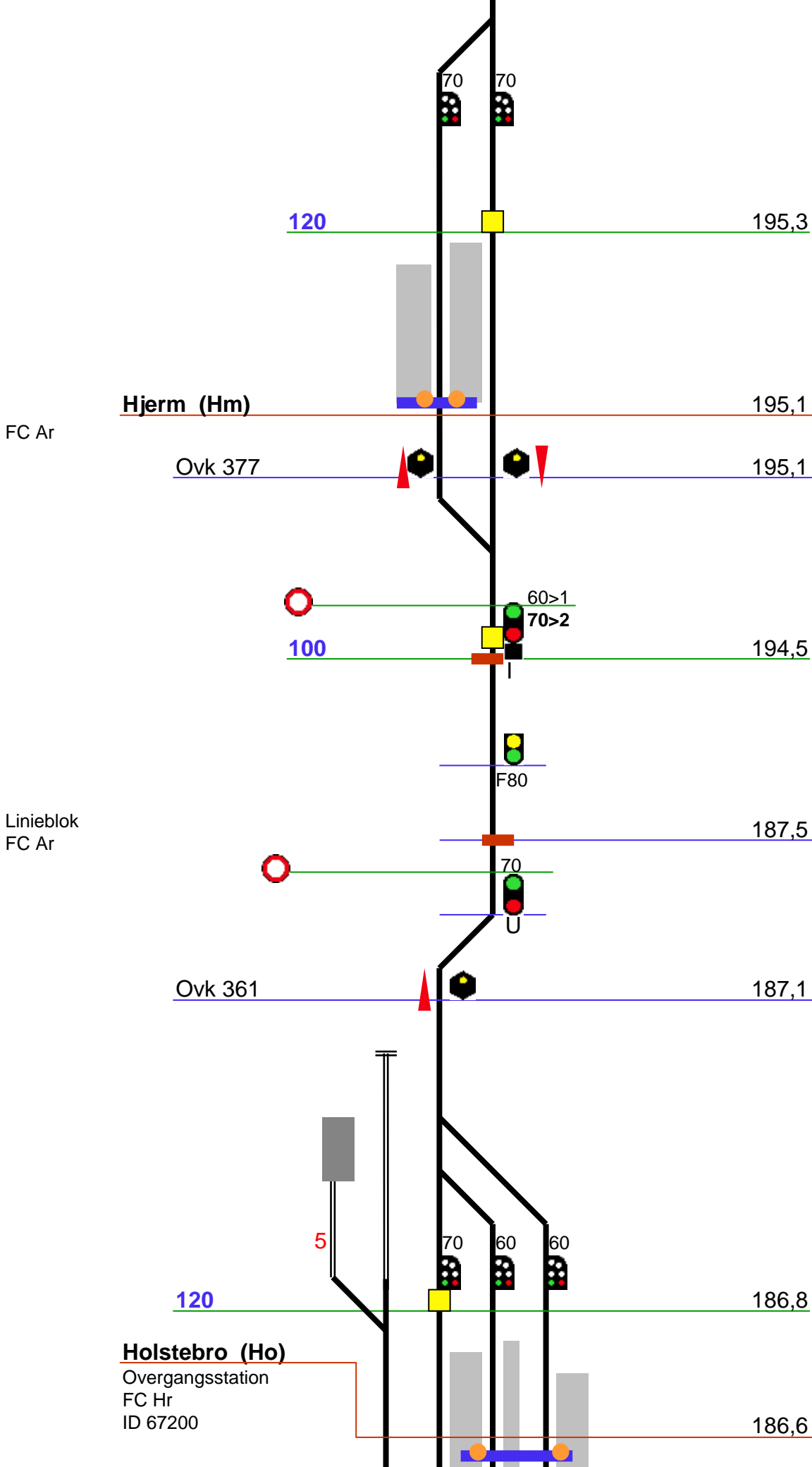

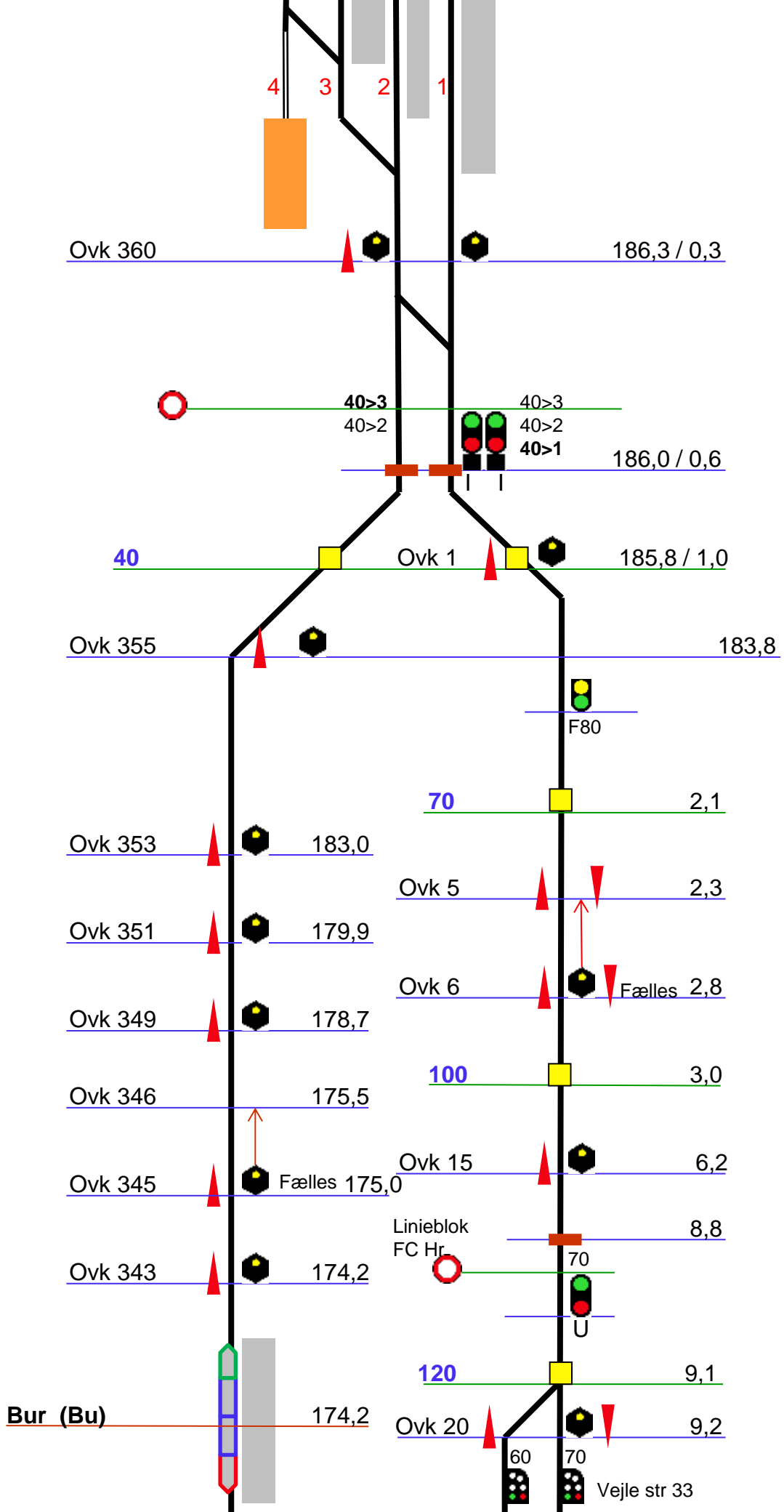

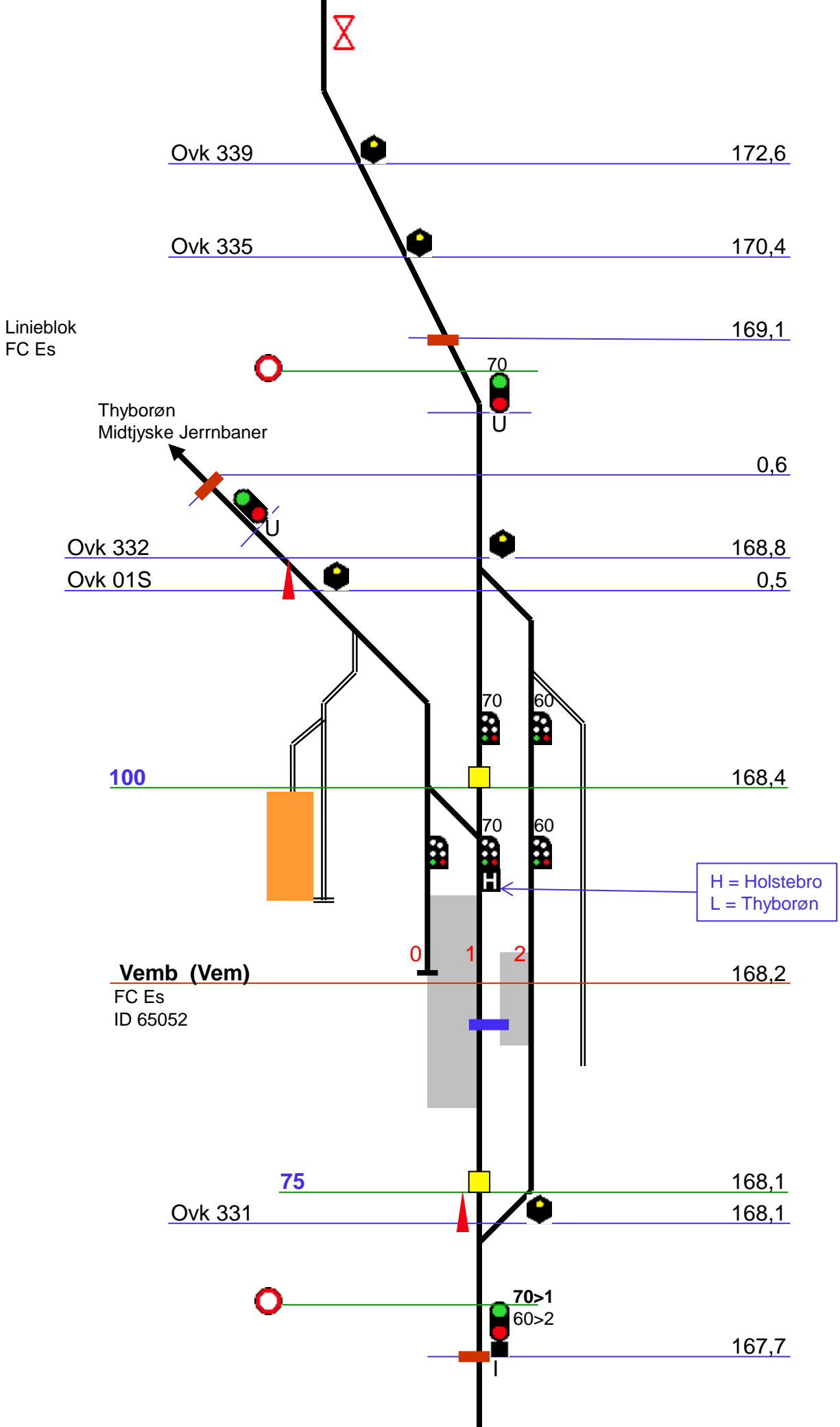

Linieblok
FC Es

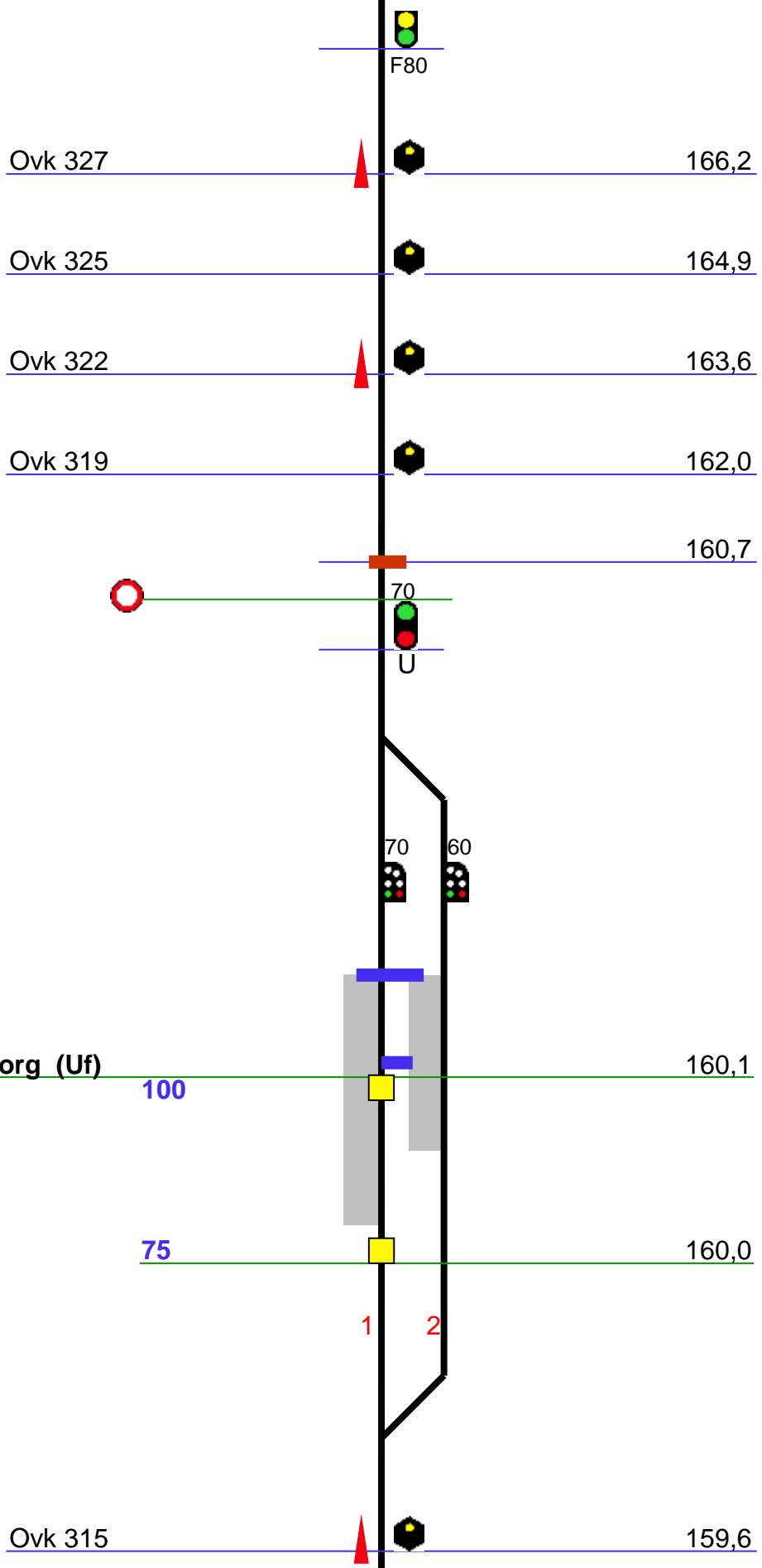

FC Es

Ulfborg (Uf)

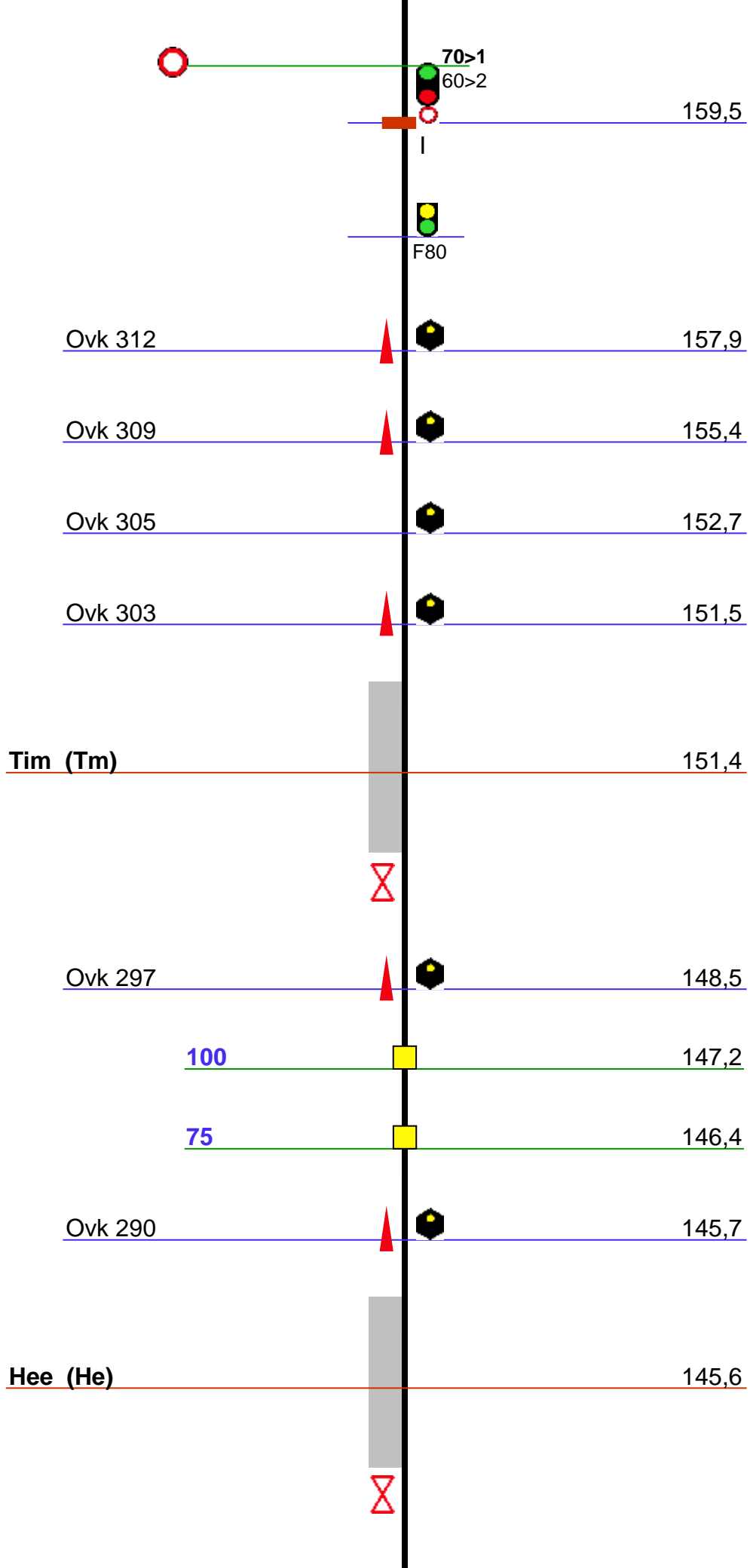

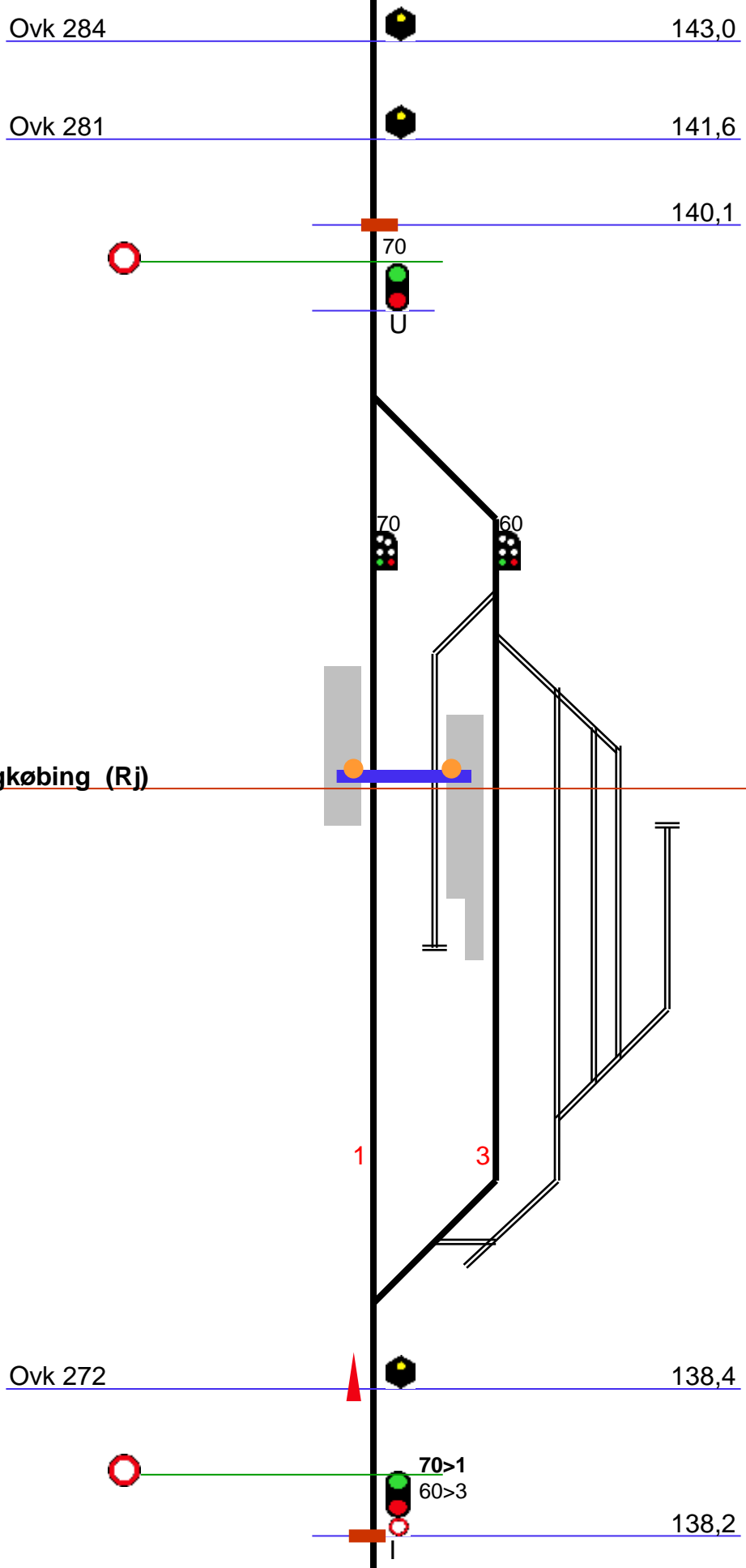

Linieblok
FC Es

FC Es

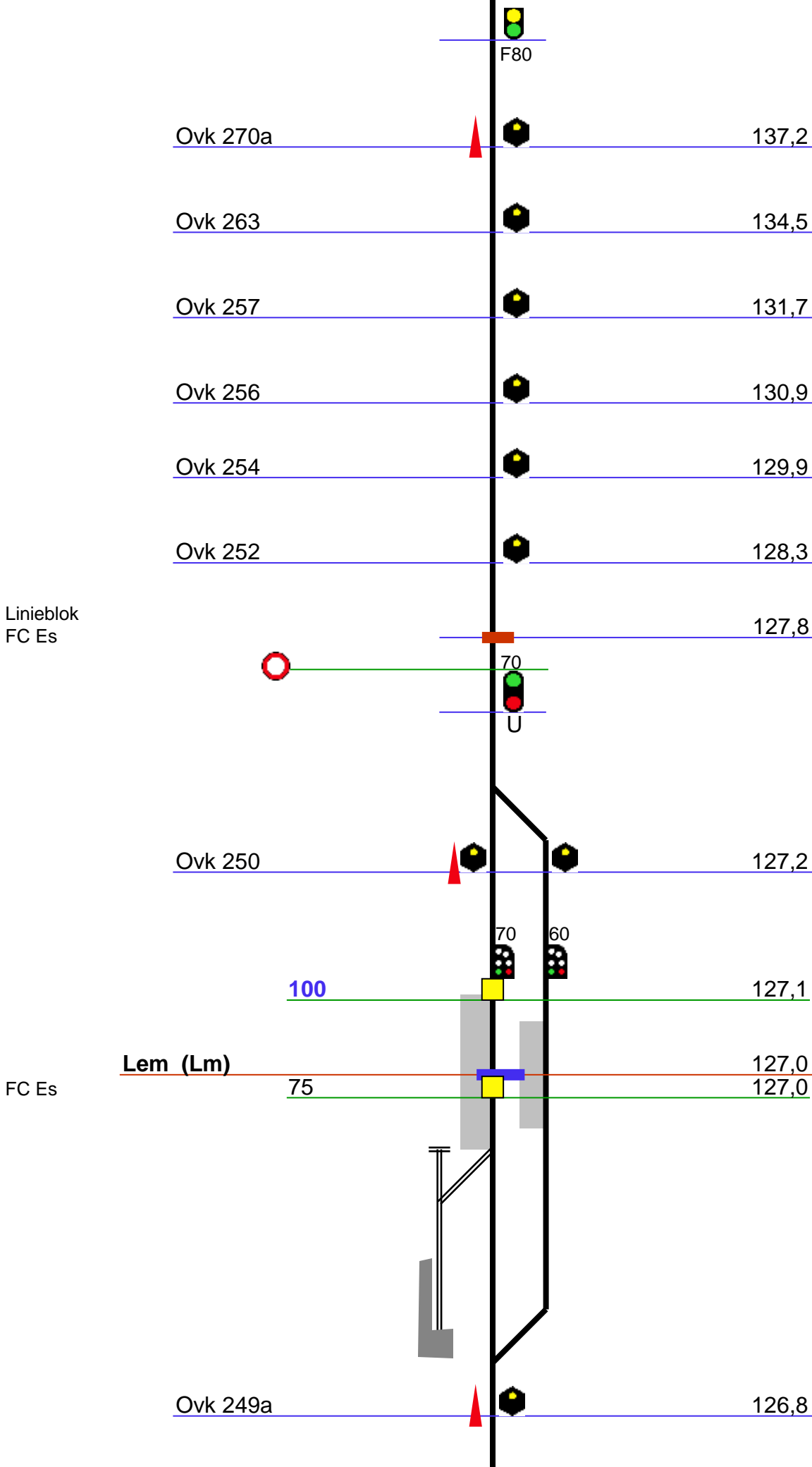

Linieblok
FC Es

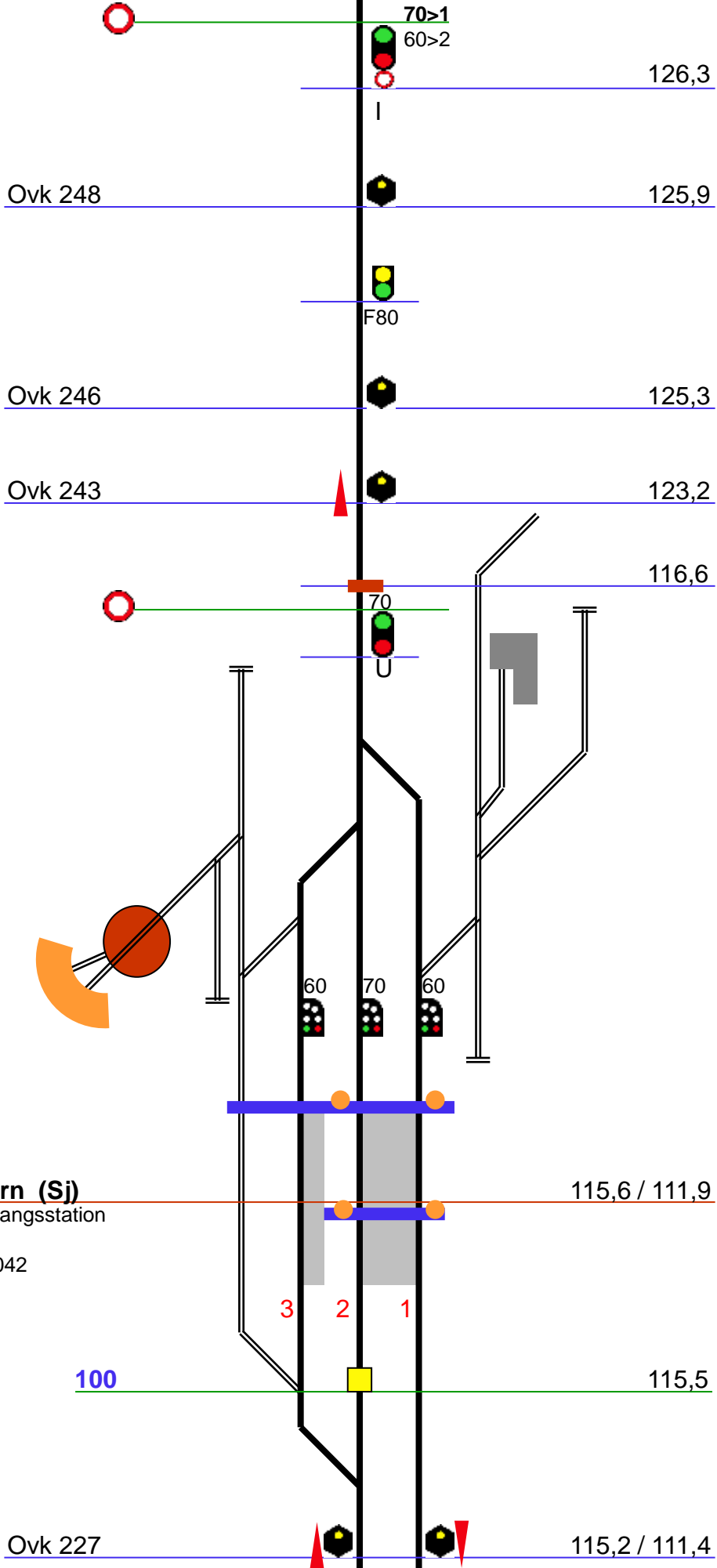

90

115,1

Ovk 226

114,8

Ovk 277

111,0



60>3
70>2



114,6

Ovk 276

110,9

Ovk 225

114,1

Ovk 275

60>3
60>2
70>1



90

110,7

F80

Ovk 221

111,9

F80

Tarm (Ta)

111,1 Ovk 272

109,8

Ovk 269

109,0

Ovk 218

111,0

Ovk 264

107,9

Ovk 212

108,2

Ovk 260

107,1

Ovk 208

105,9

Ovk 255

106,0

Ovk 207a

105,1

Ovk 252

105,1

Ovk 198

99,7

Ovk 247

103,7

Linieblok
FC Es



70



98,8

Ovk 241

102,6



Skanderborg str 35

FC Es

Ølgod (Øg) 98,0



1 2

Ovk 195 97,6



97,3



Ovk 190 95,4

Ovk 188 94,2

Gårde (Gå) 92,9



Linieblok
FC Es

87,8

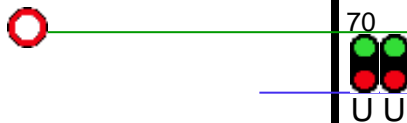

FC Es

Tistrup (Tr)

87,4

70

60



70>2
60>1



I

86,7



F80

Sig (Is)

81,5



Varde Nord (Vno)

75,2



Ovk 145



75,0

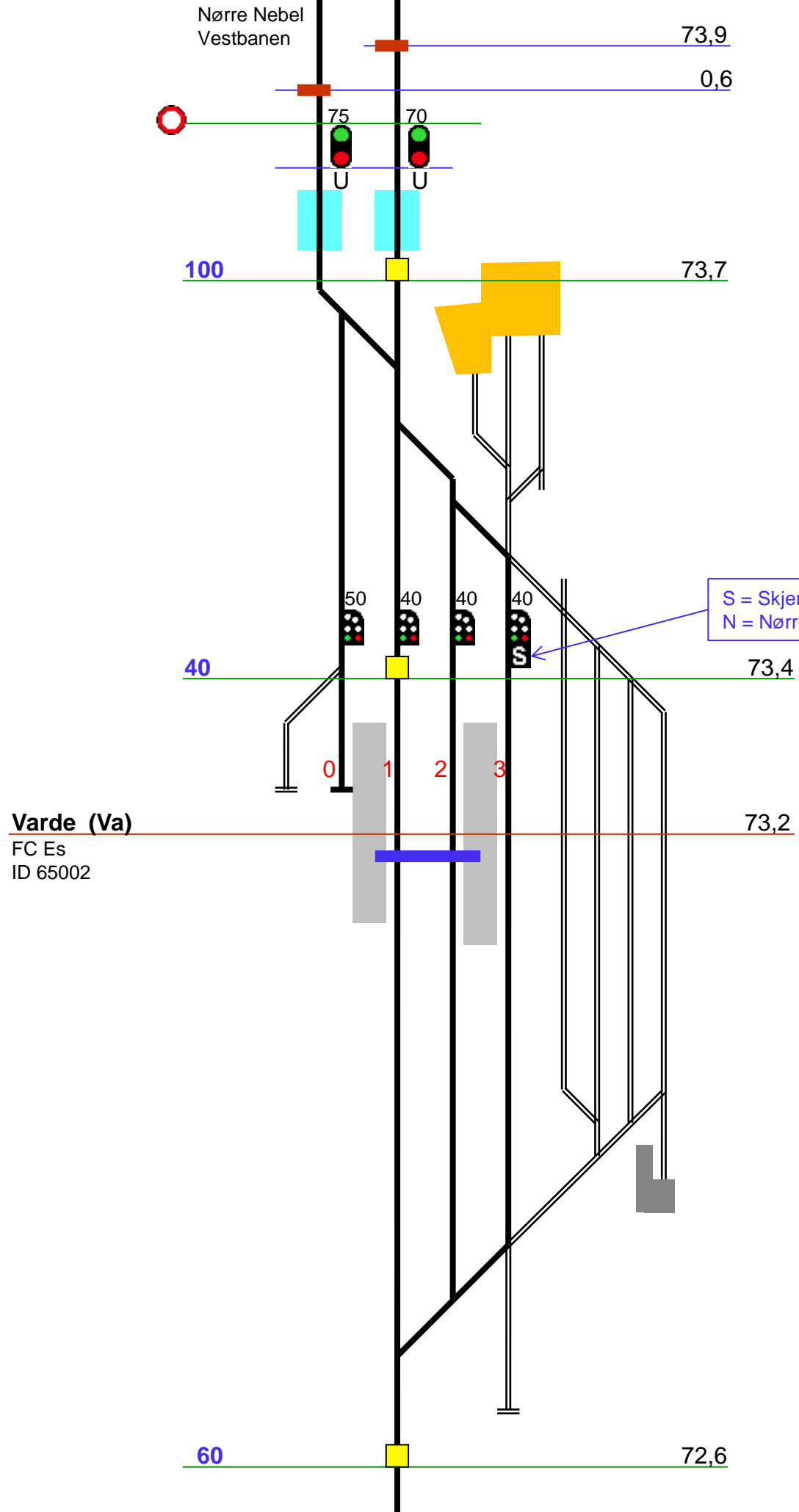

S = Skjern
N = Nørre Nebel

Varde kaserne (Vka)

72,4



60>1
60>2
60>3



71,8

I



F80

Linieblok
FC Es

63,8



70
U

Guldager (Gu)

63,3

FC Es

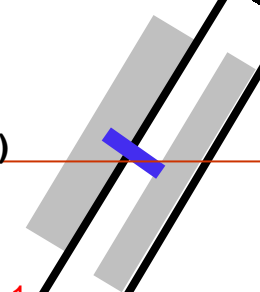

60

70

1

2

Ovk 119



62,6

60>1
70>2



62,6

I



F80

Bramming

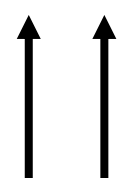

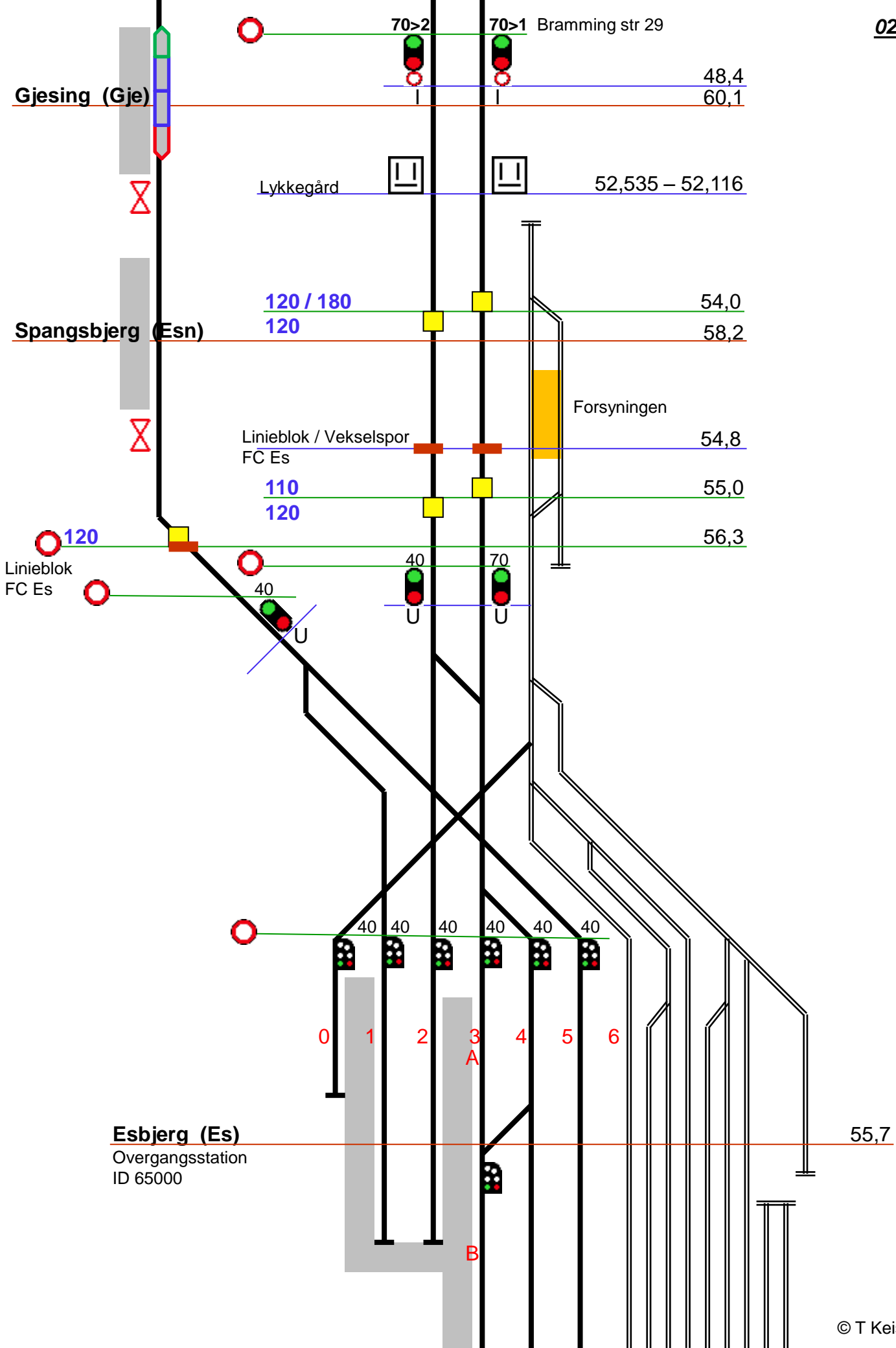

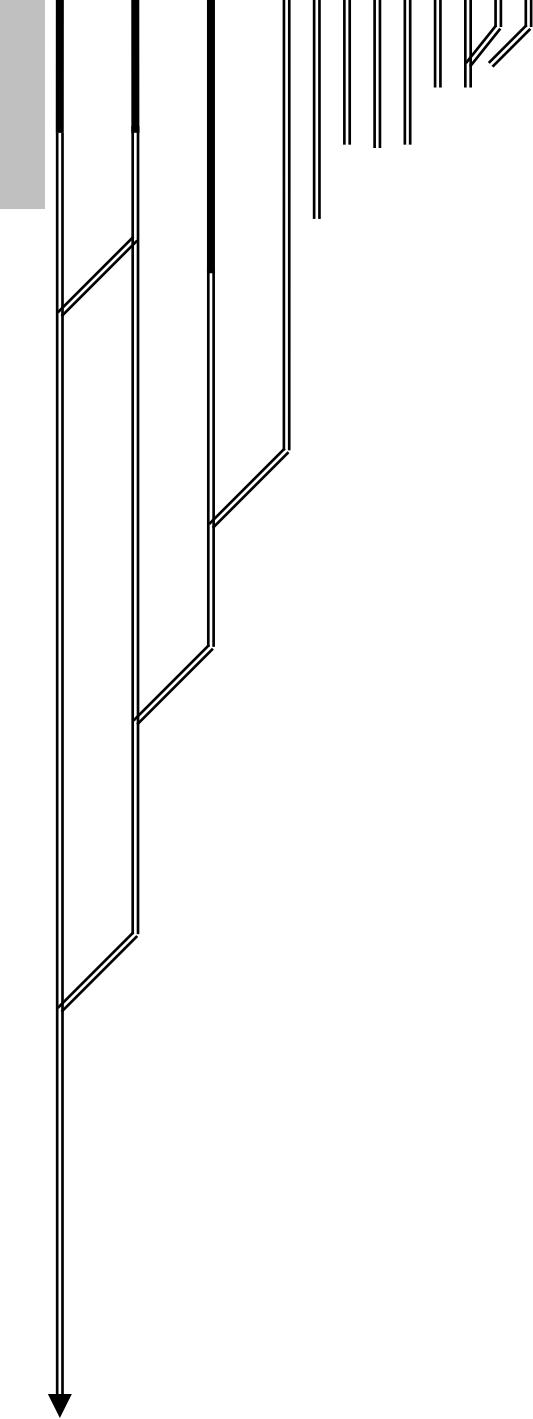

Havnen