

Linieblok  
FC Es

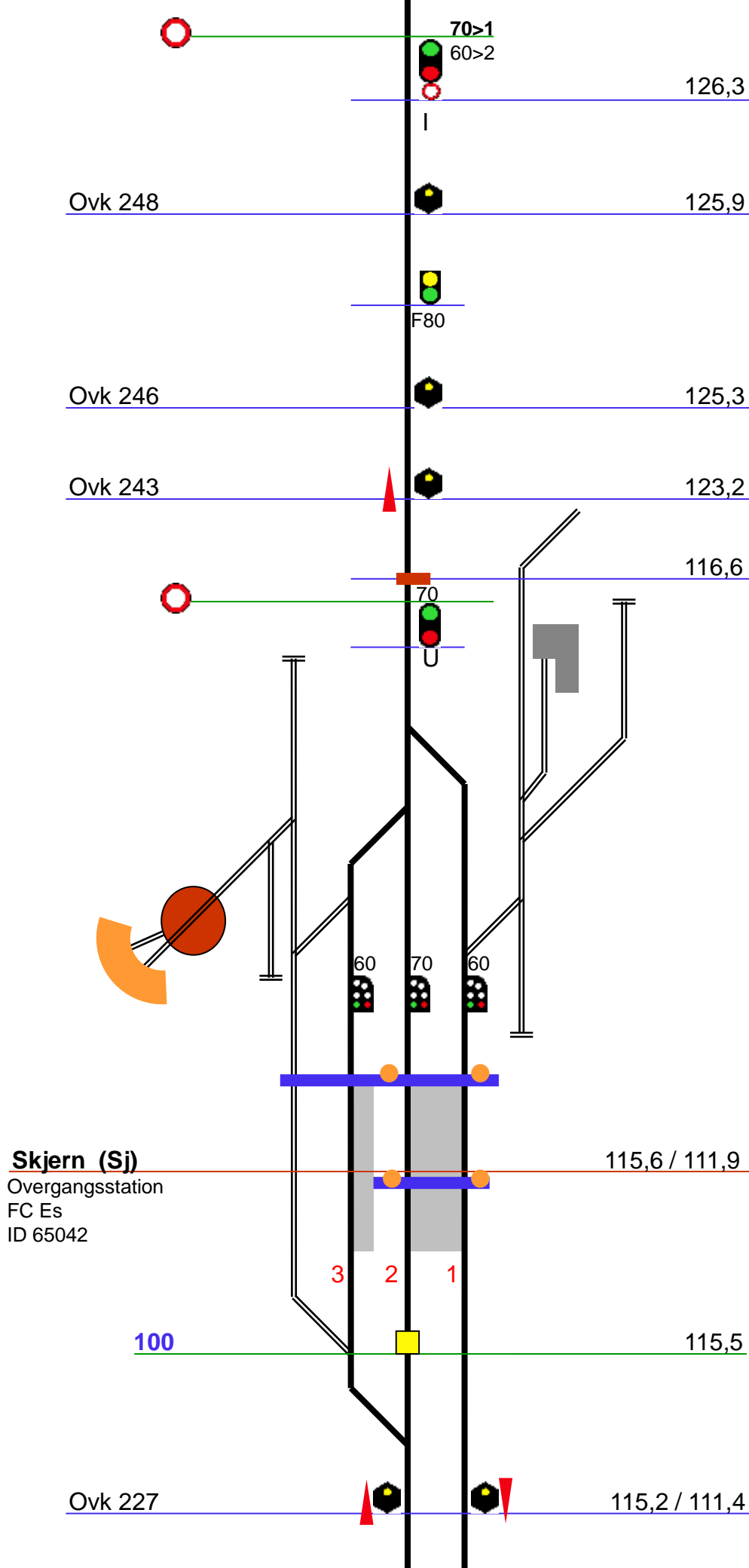

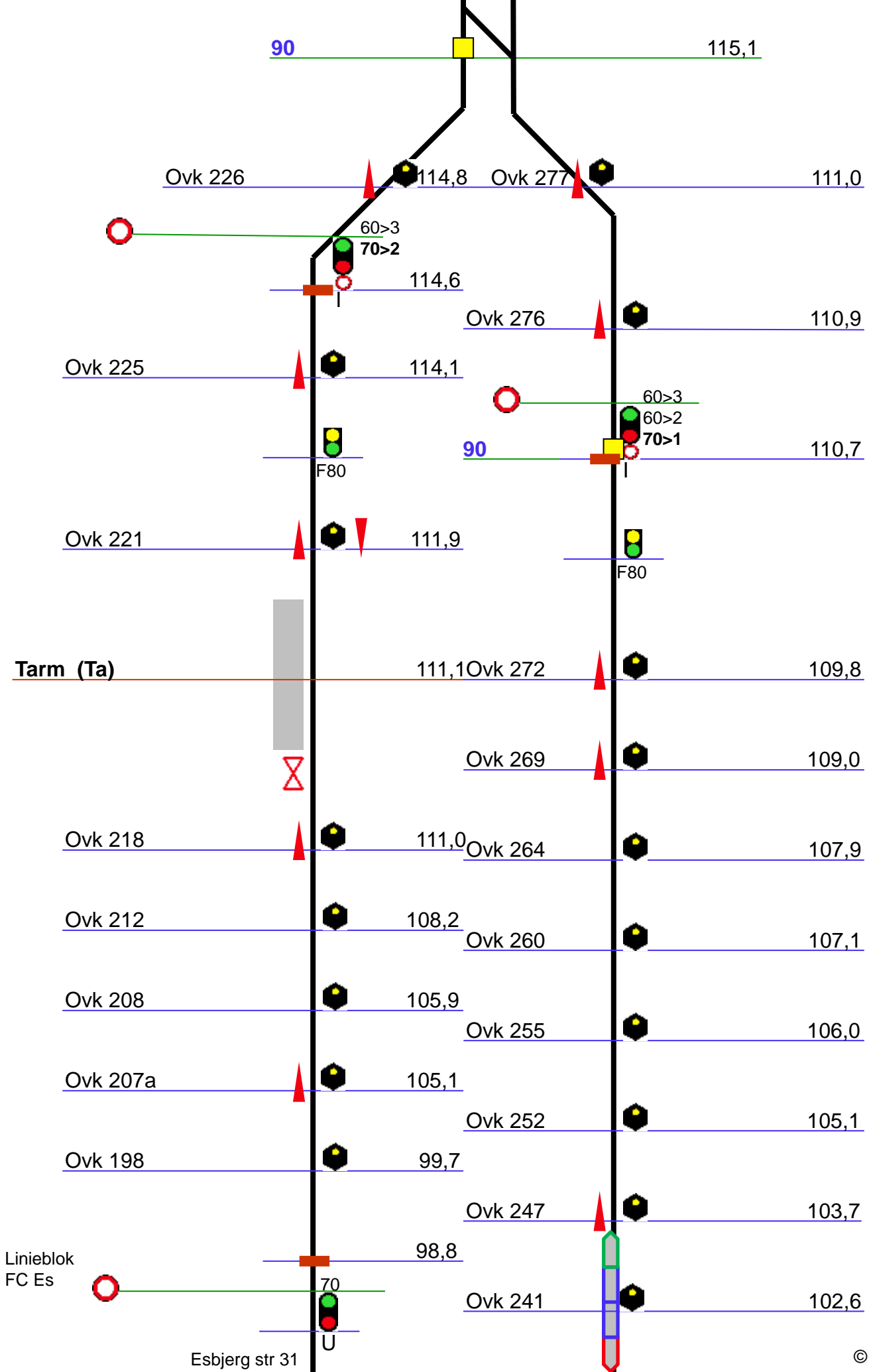

Linieblok  
FC Es

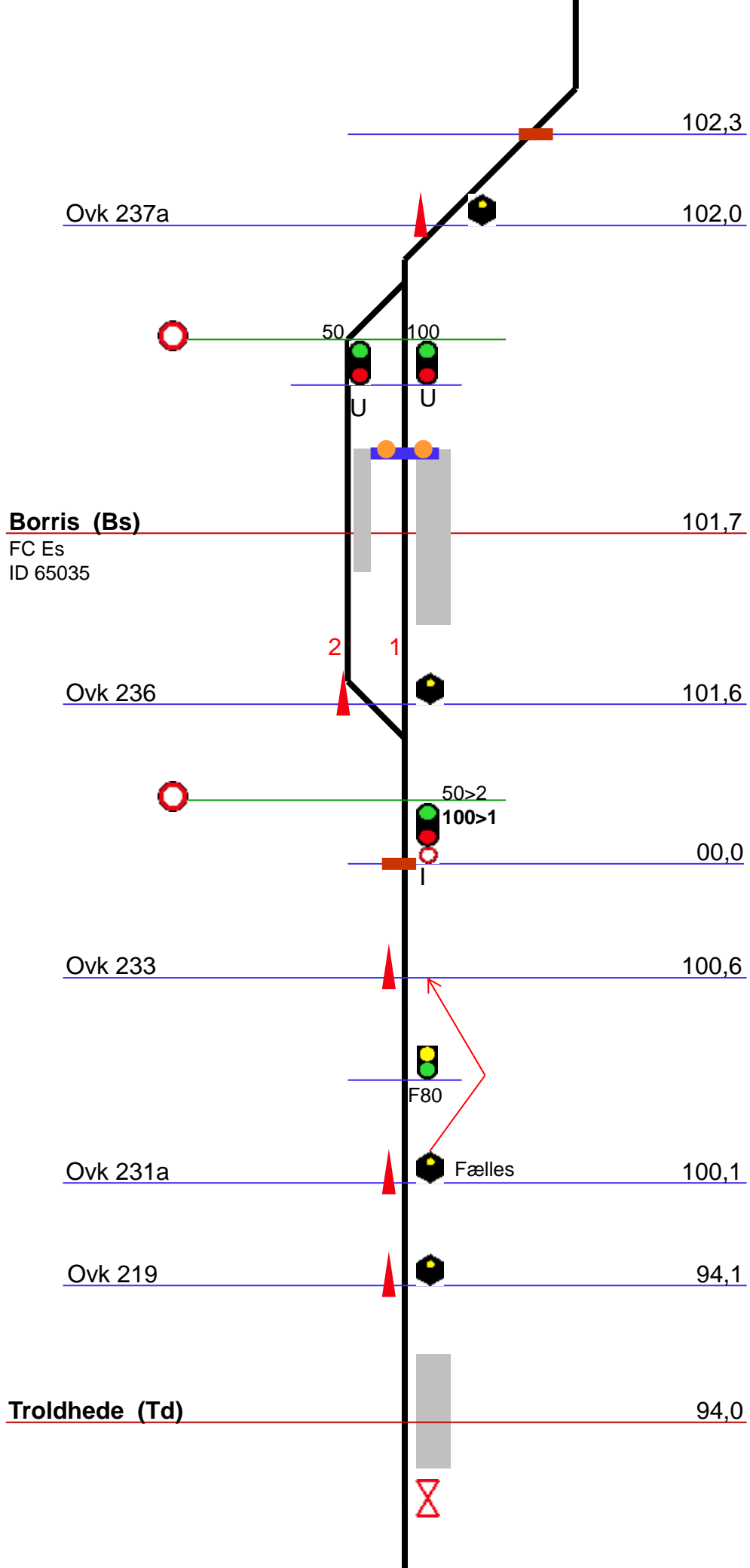

Linieblok  
FC Es

FC Es

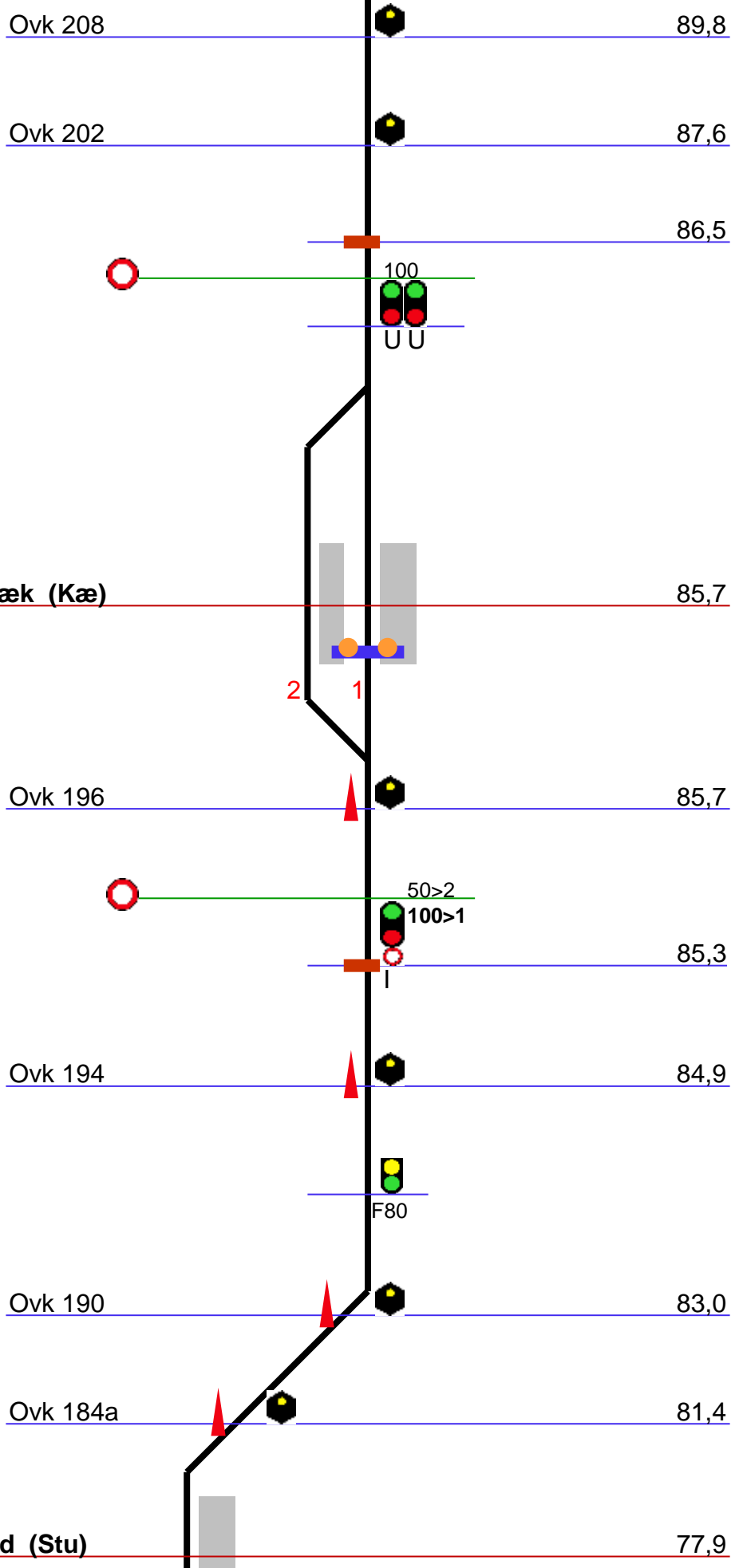

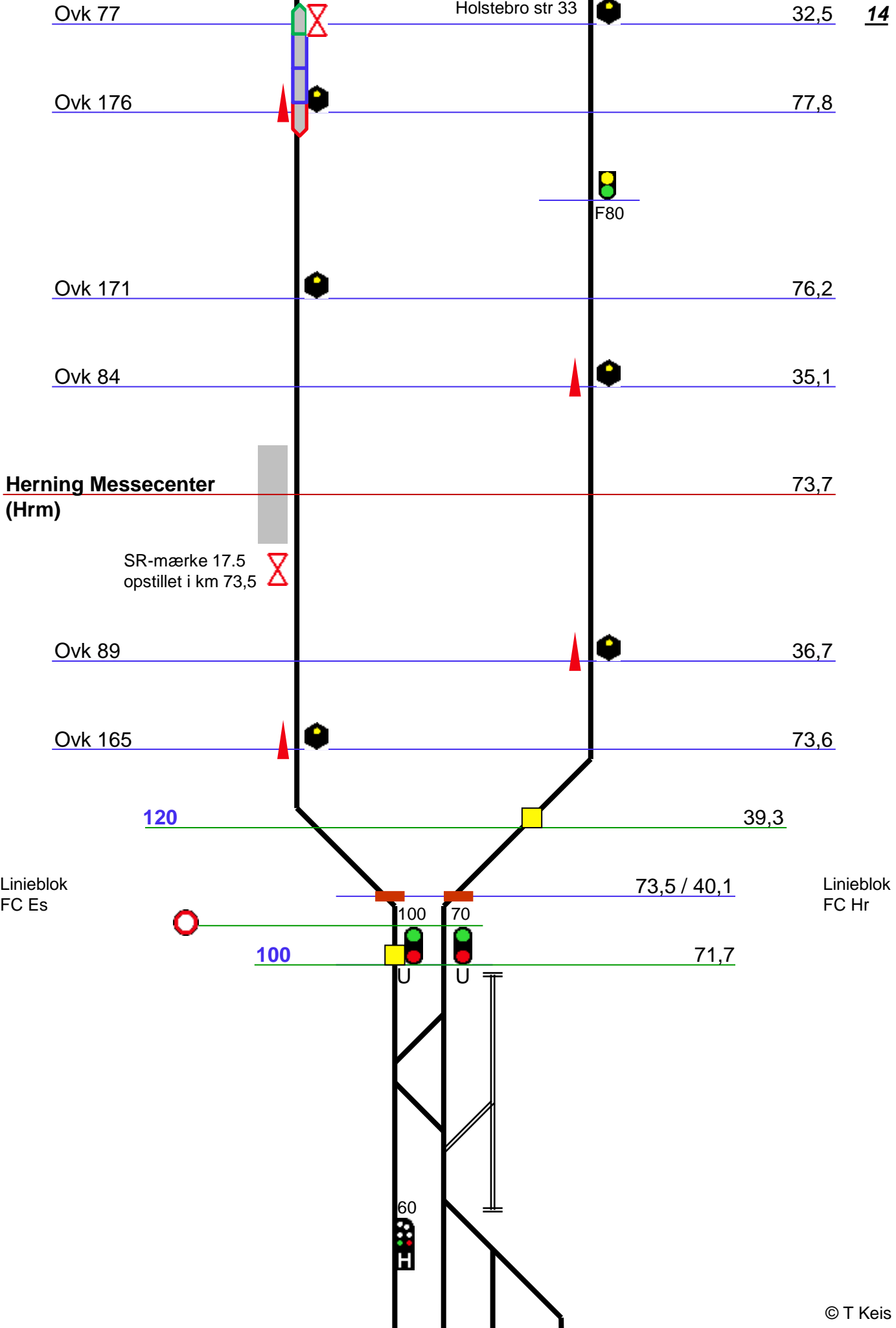

**Herning (Hr)**  
Overgangsstation  
ID 63700

71,2

H = Holstebro  
S = Skjern

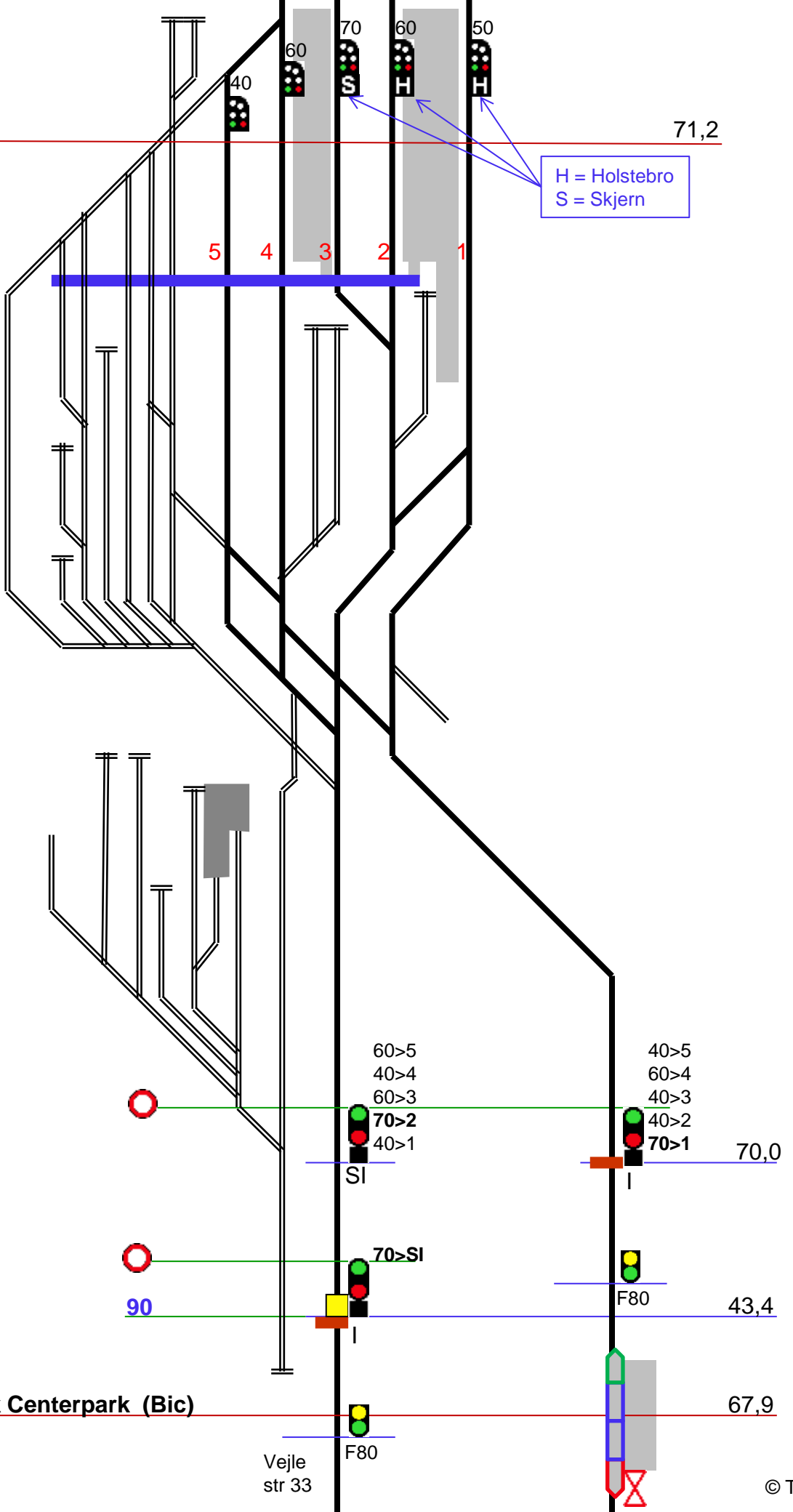

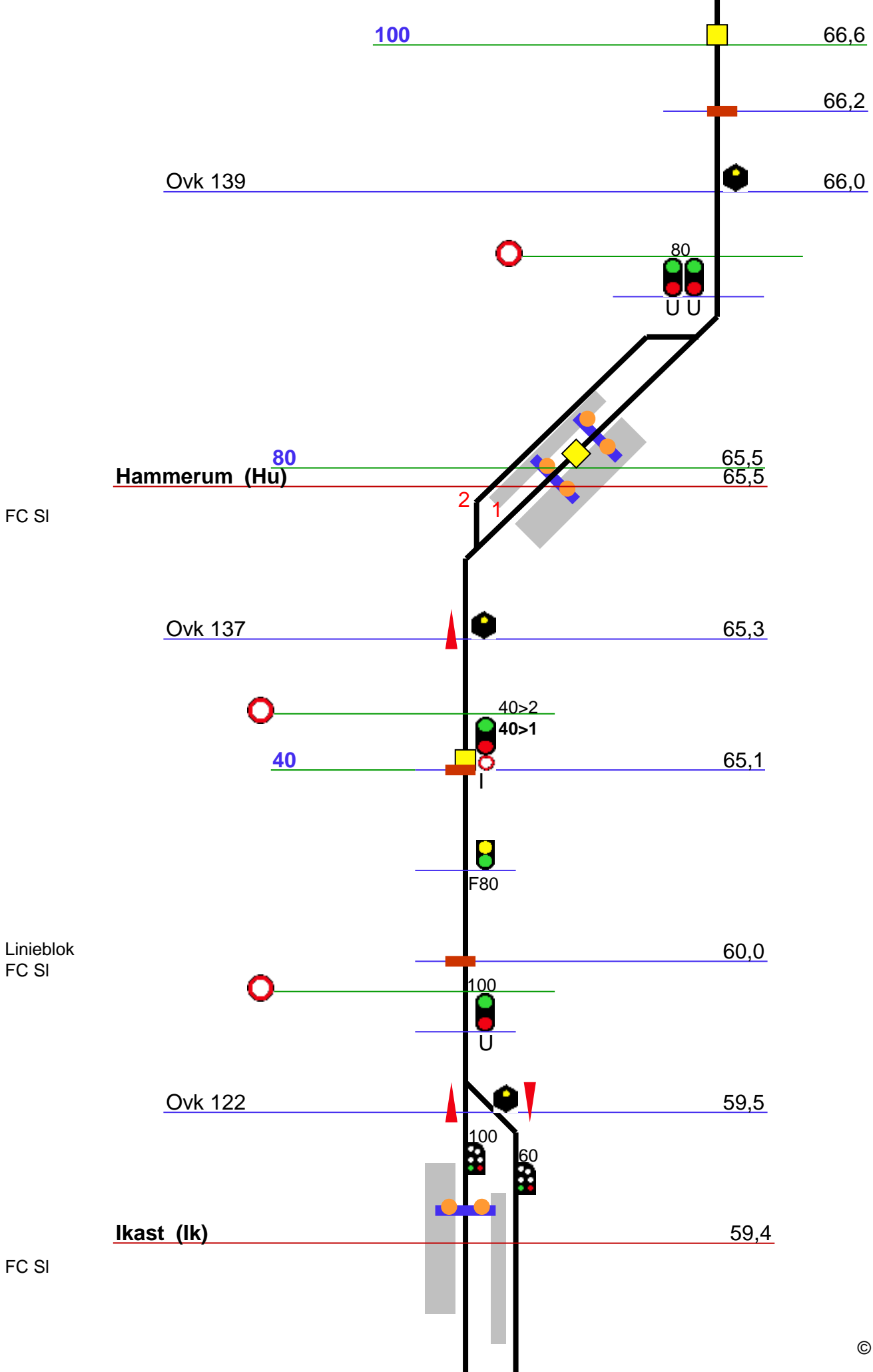

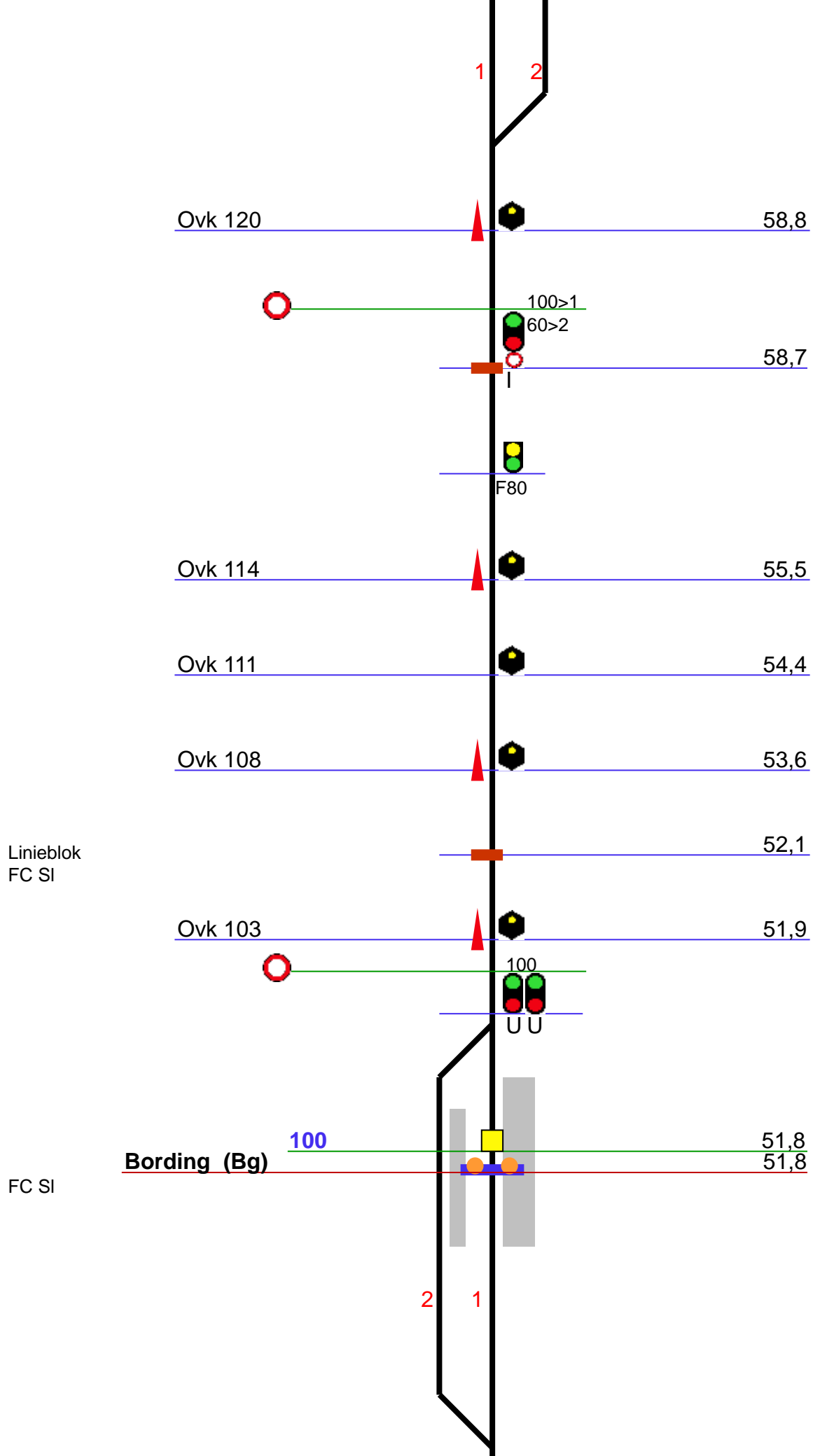



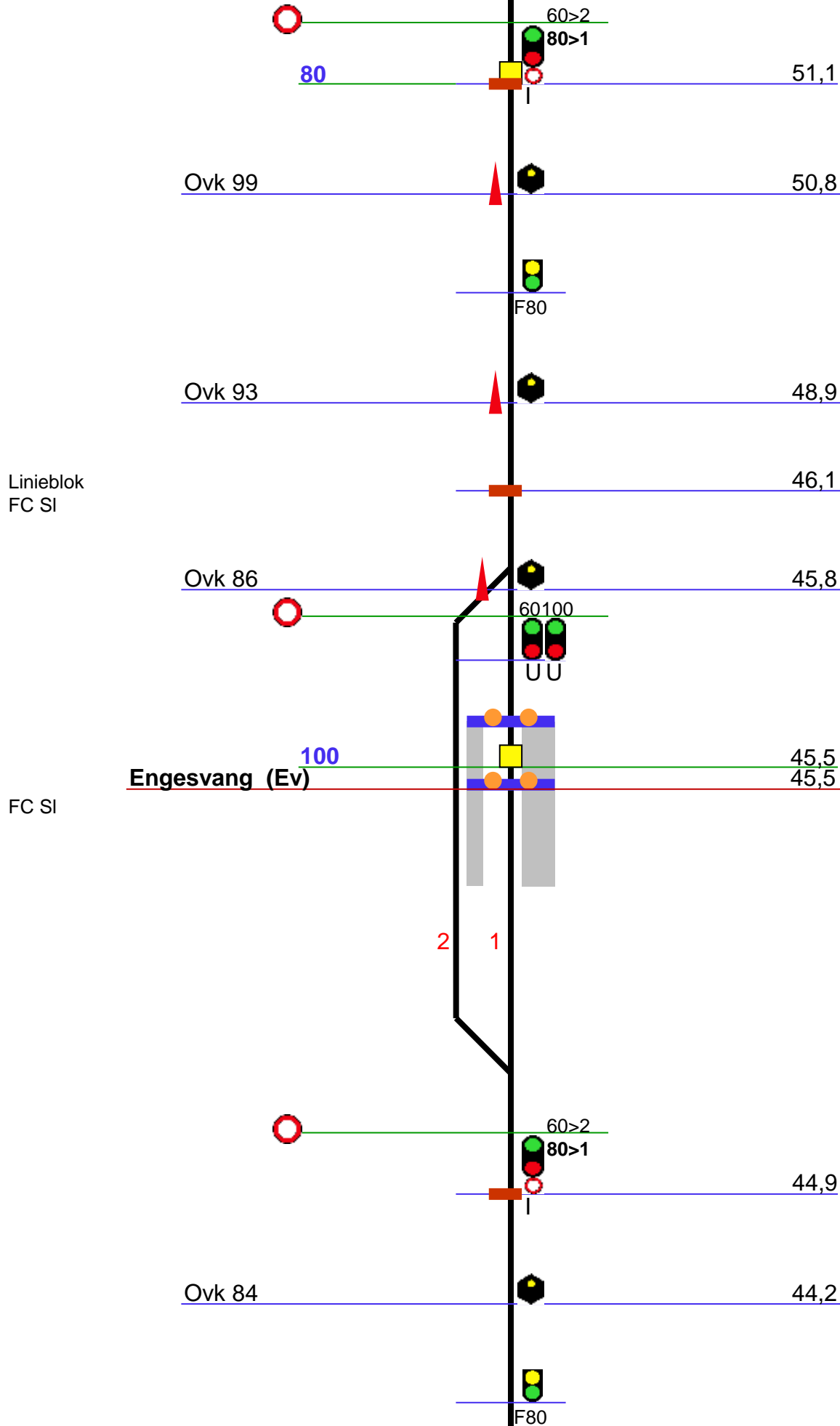

Linieblok  
FC SI

FC SI

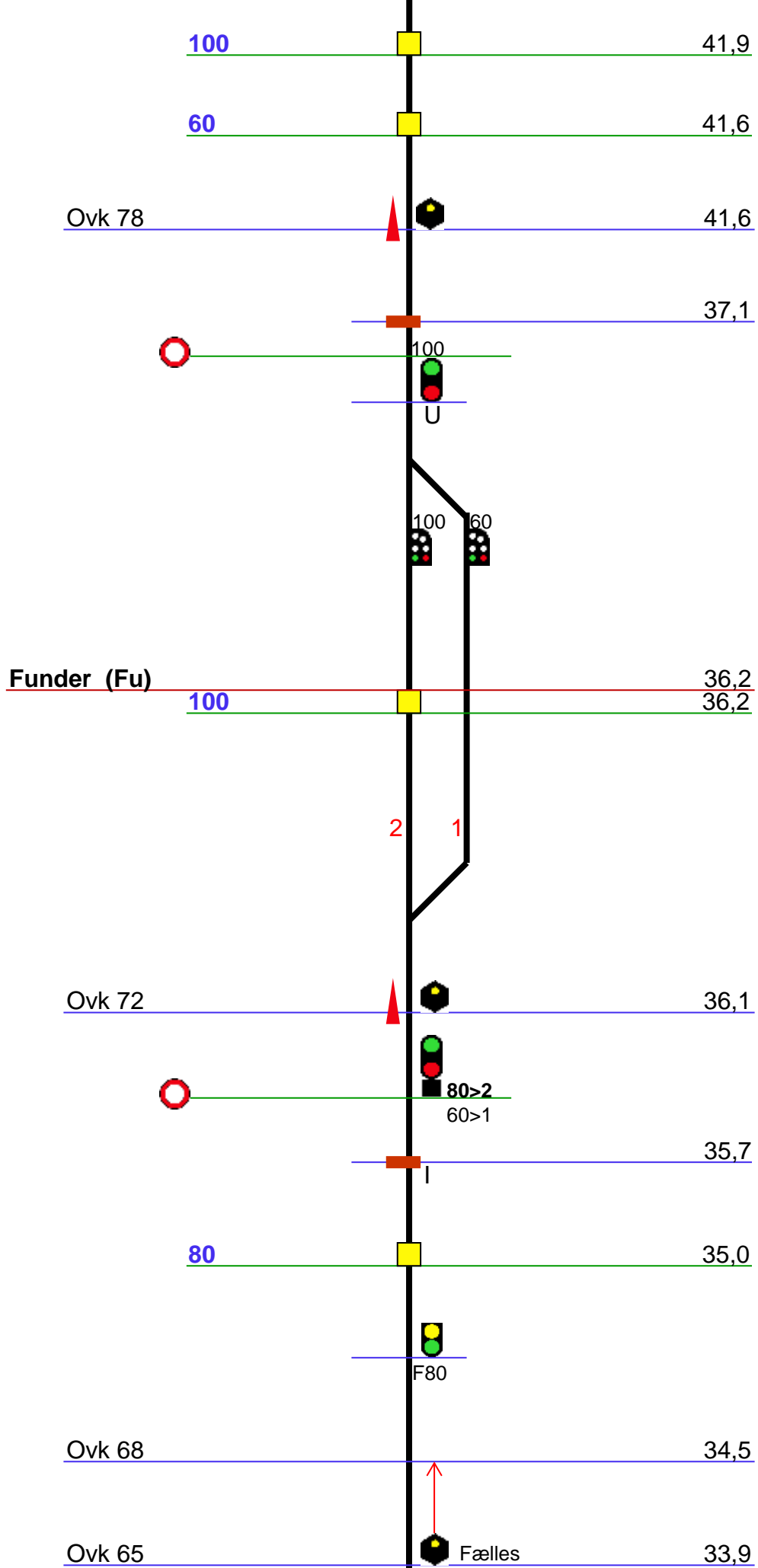

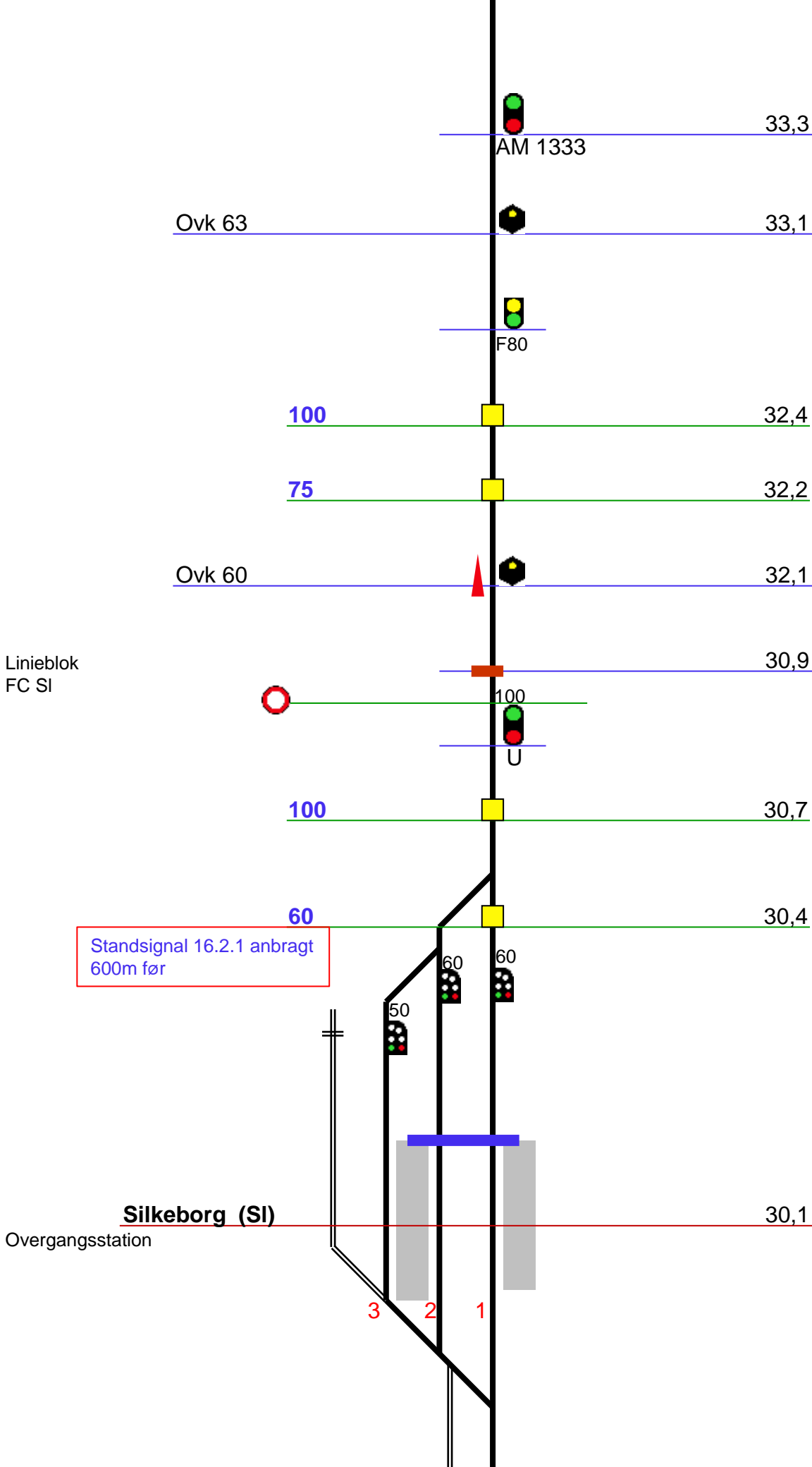

Linieblok  
FC SI

FC SI

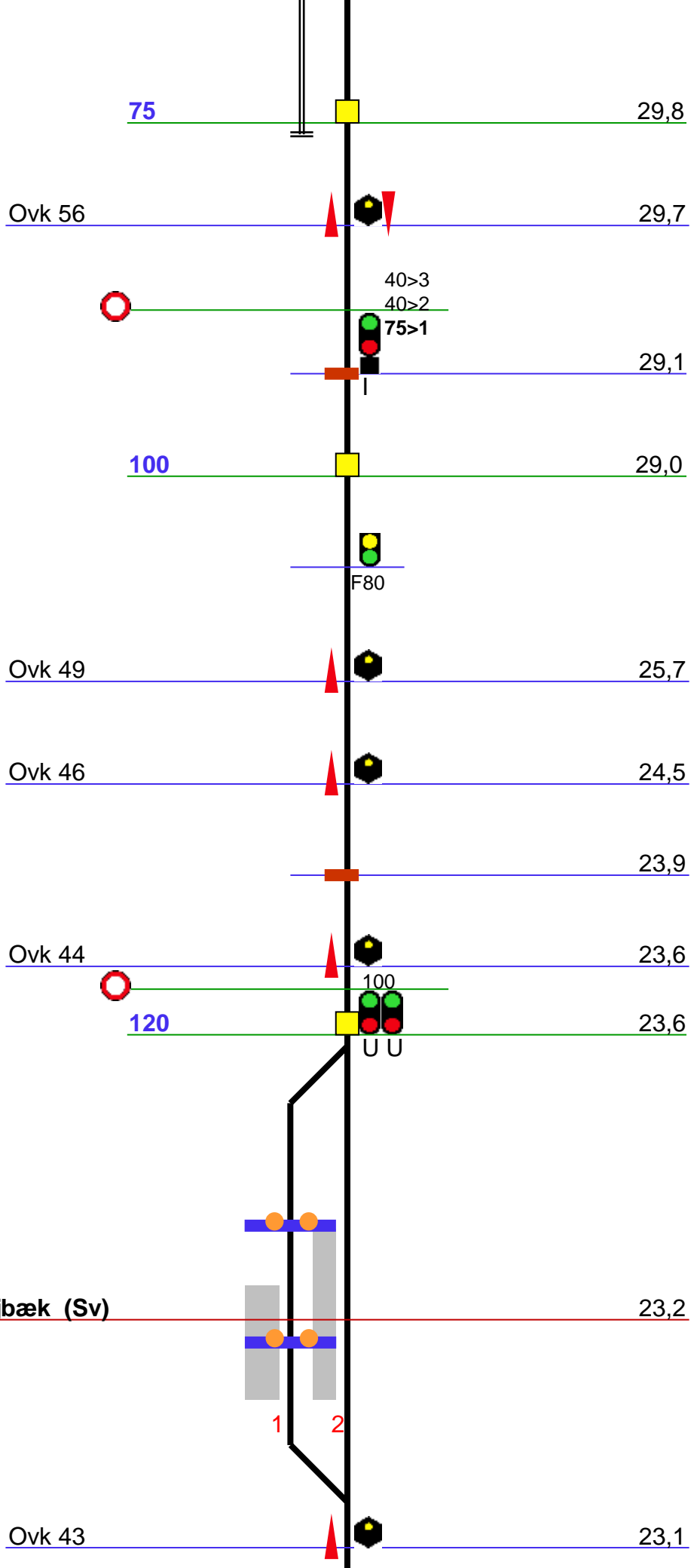

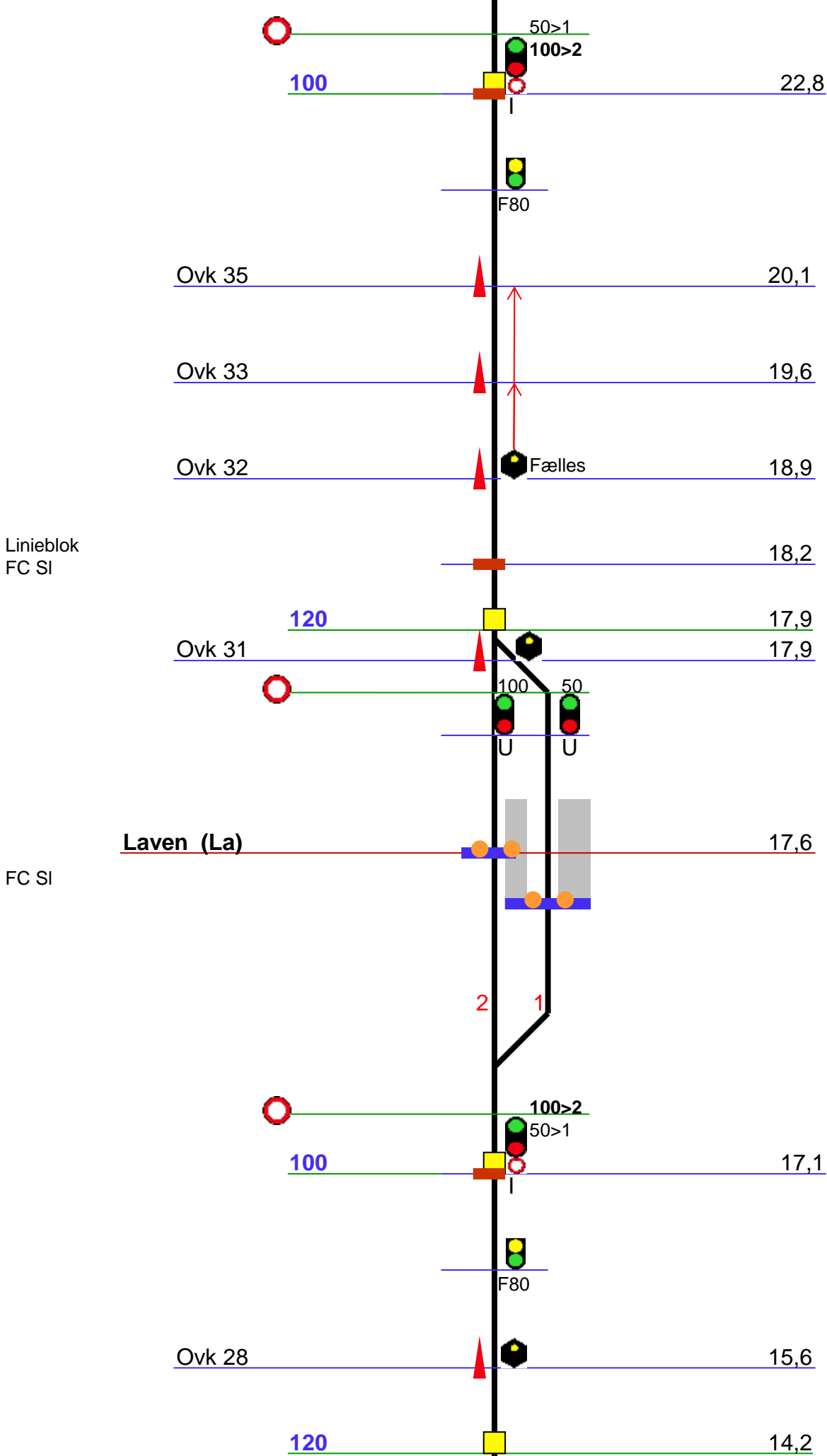

Linieblok  
FC SI

Ovk 25 13,9



Ovk 24 12,6



Ovk 23 12,4

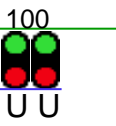

Ry (Ry) 12,3

FC SI

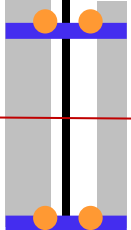

1 2

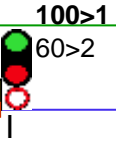

100

11,5

I



Alken (Ak) 5,1

Ovk 14 5,0



120

0,7



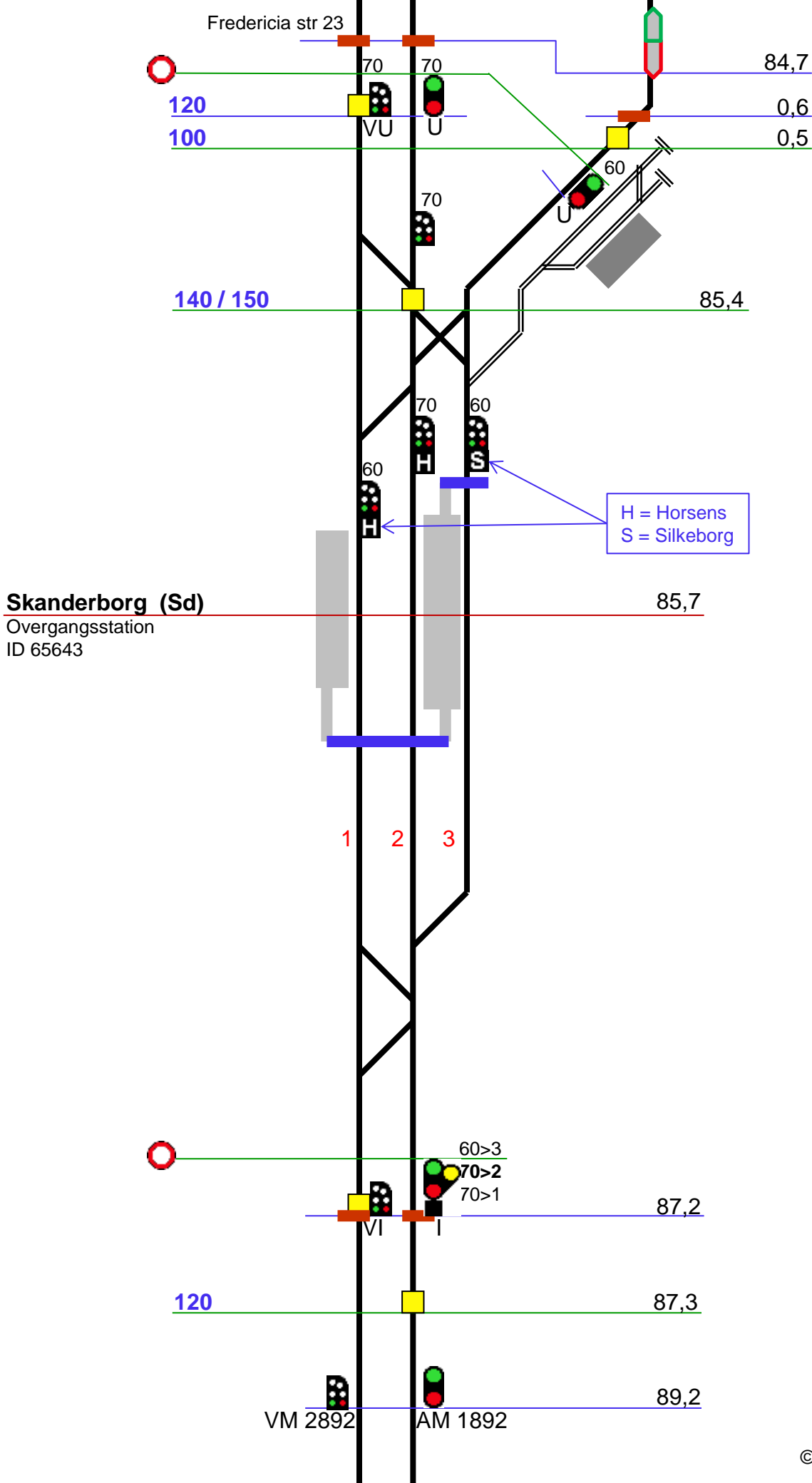

Linieblok  
FC Sd

FC Sd

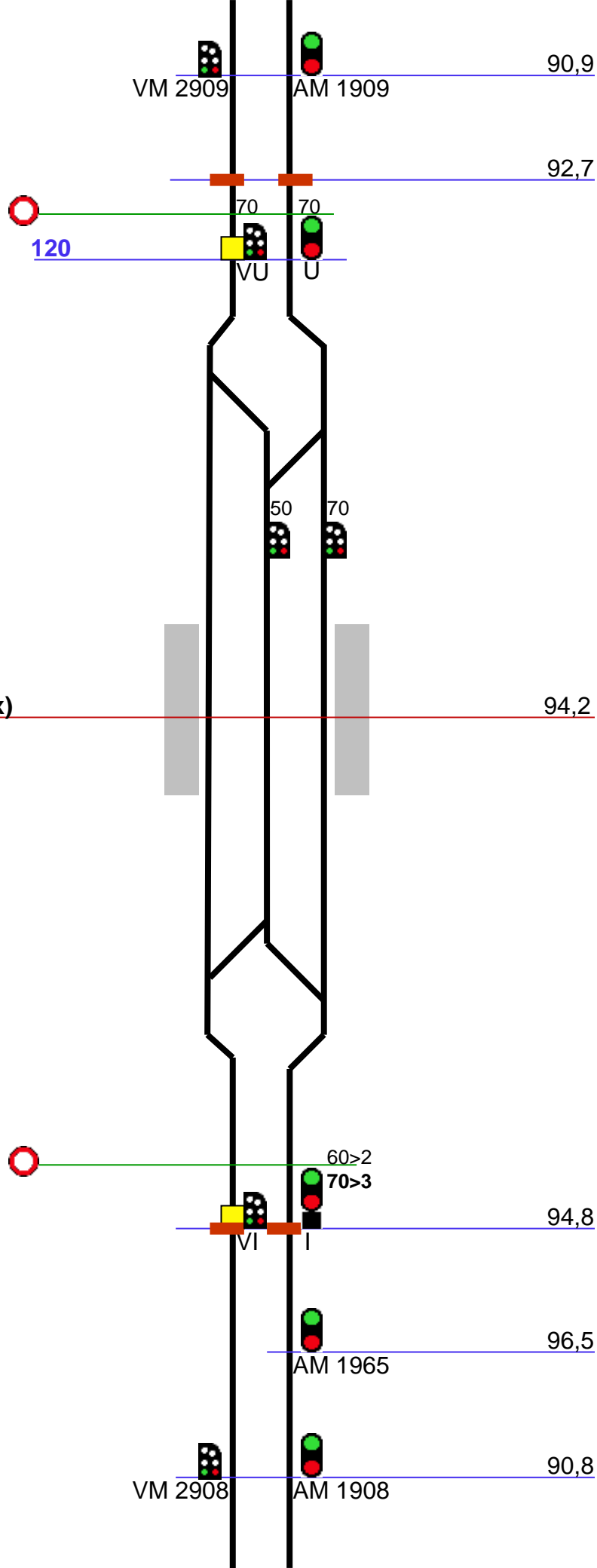



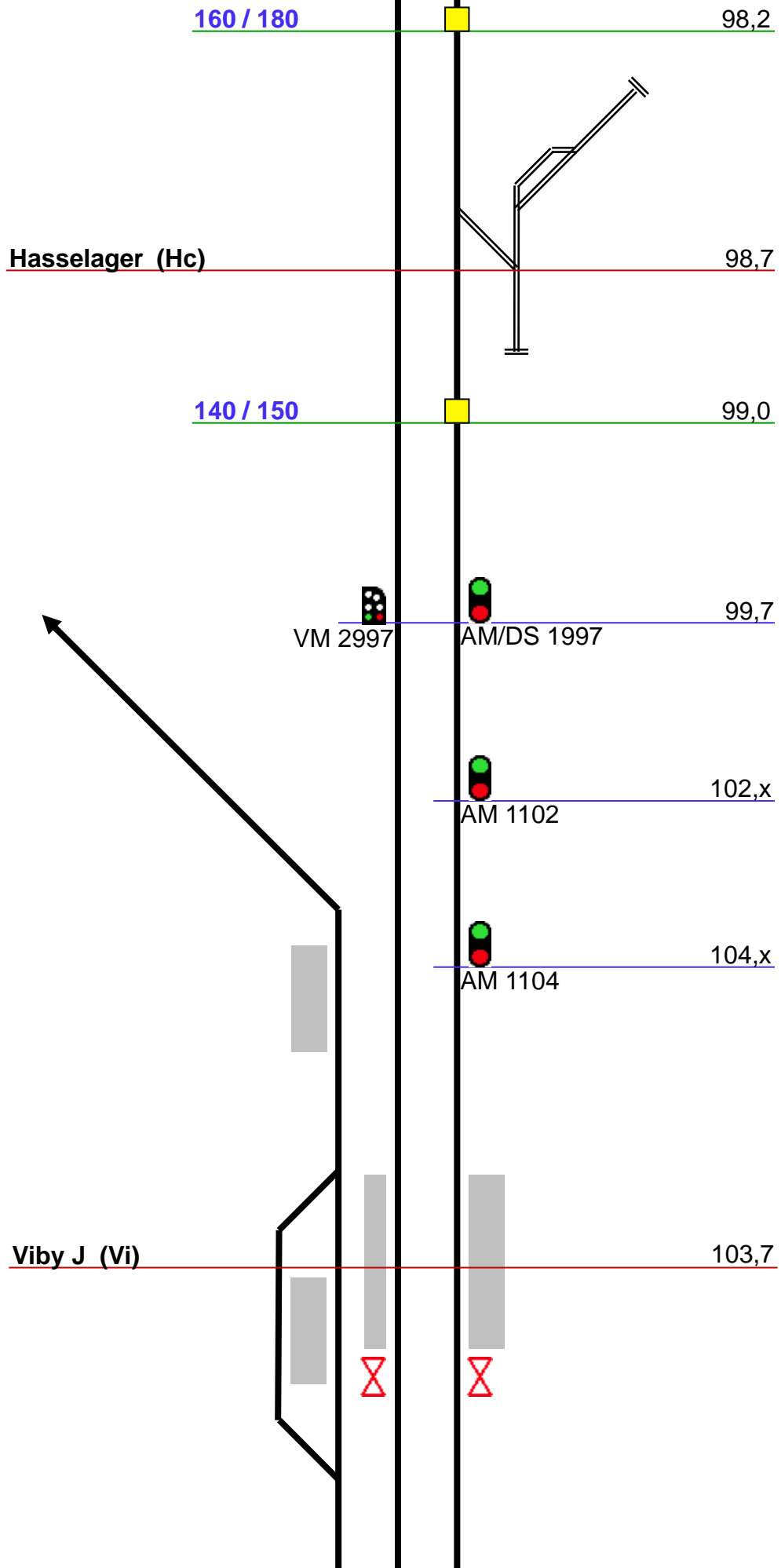

Linieblok  
FC Sd

Aalborg  
strækning 24

02

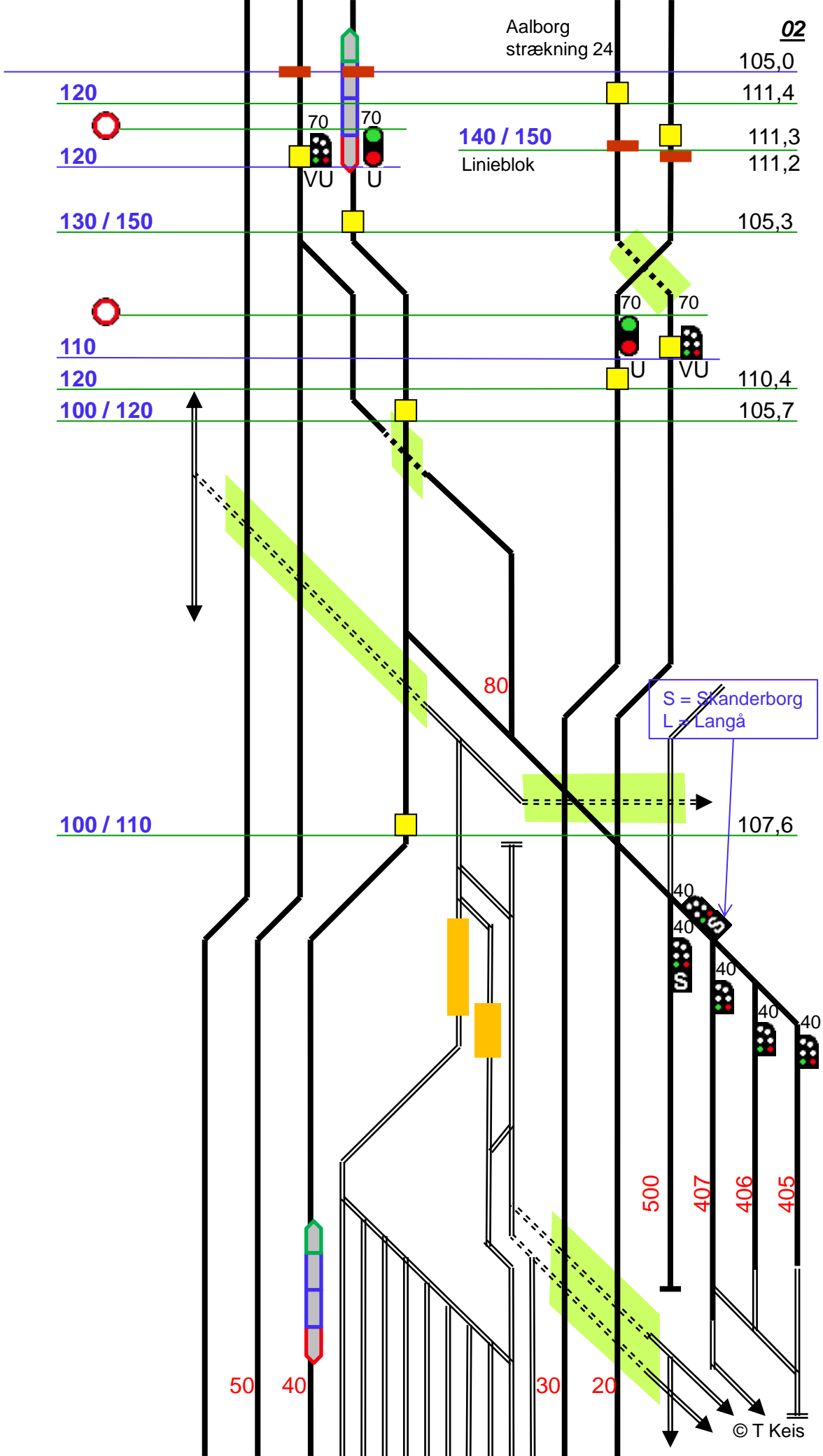

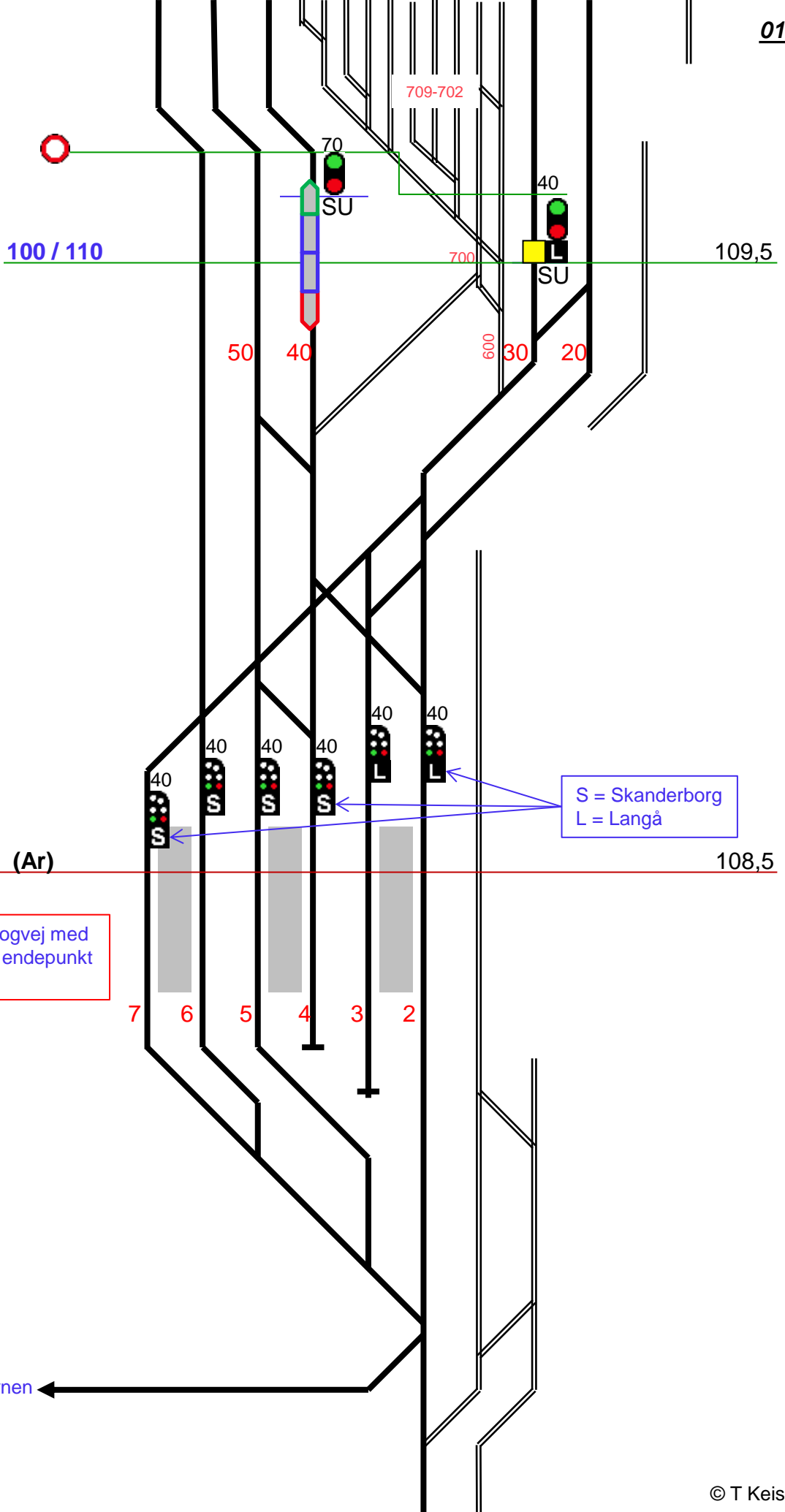

**Aarhus H (Ar)**

Overgangsstation  
ID 64000

Er der stillet en udkørselstogvej med SU-signalet i spor 30 som endepunkt vises **R** i bogstavviseren.

S = Skanderborg  
L = Langå