

Helgoland (Hgl)
Overgangsstation
ID 66100

5,2

60 > 2
 40 > 3-5
 40 > 7-11
 40 > 13-15
 40 > 30

40 > 3-5
 40 > 7-11
 40 > 13-15
 40 > 30

4,8

4,4

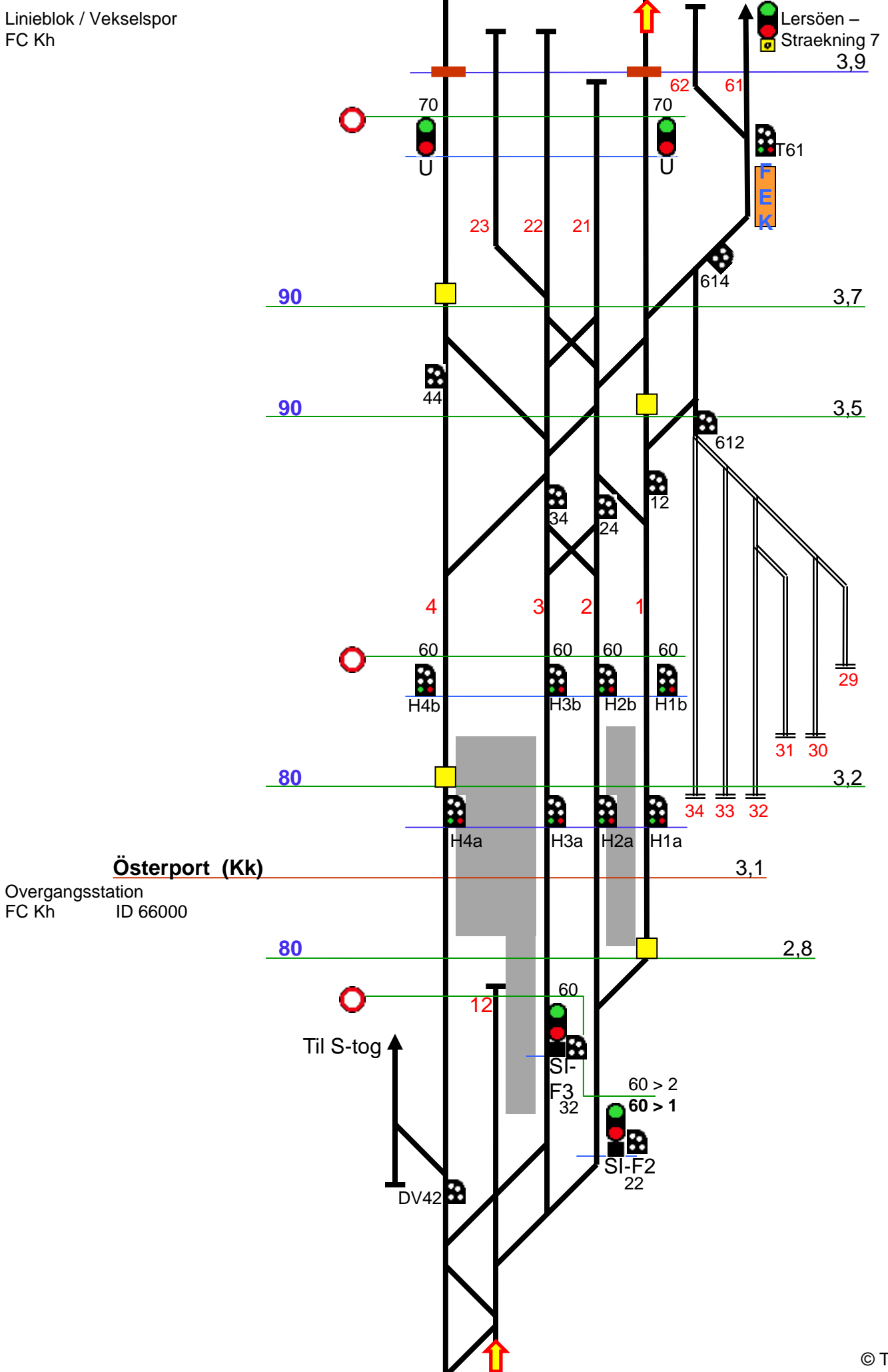

Österport (Kk)
Overgangsstation
FC Kh ID 66000

Til S-tog

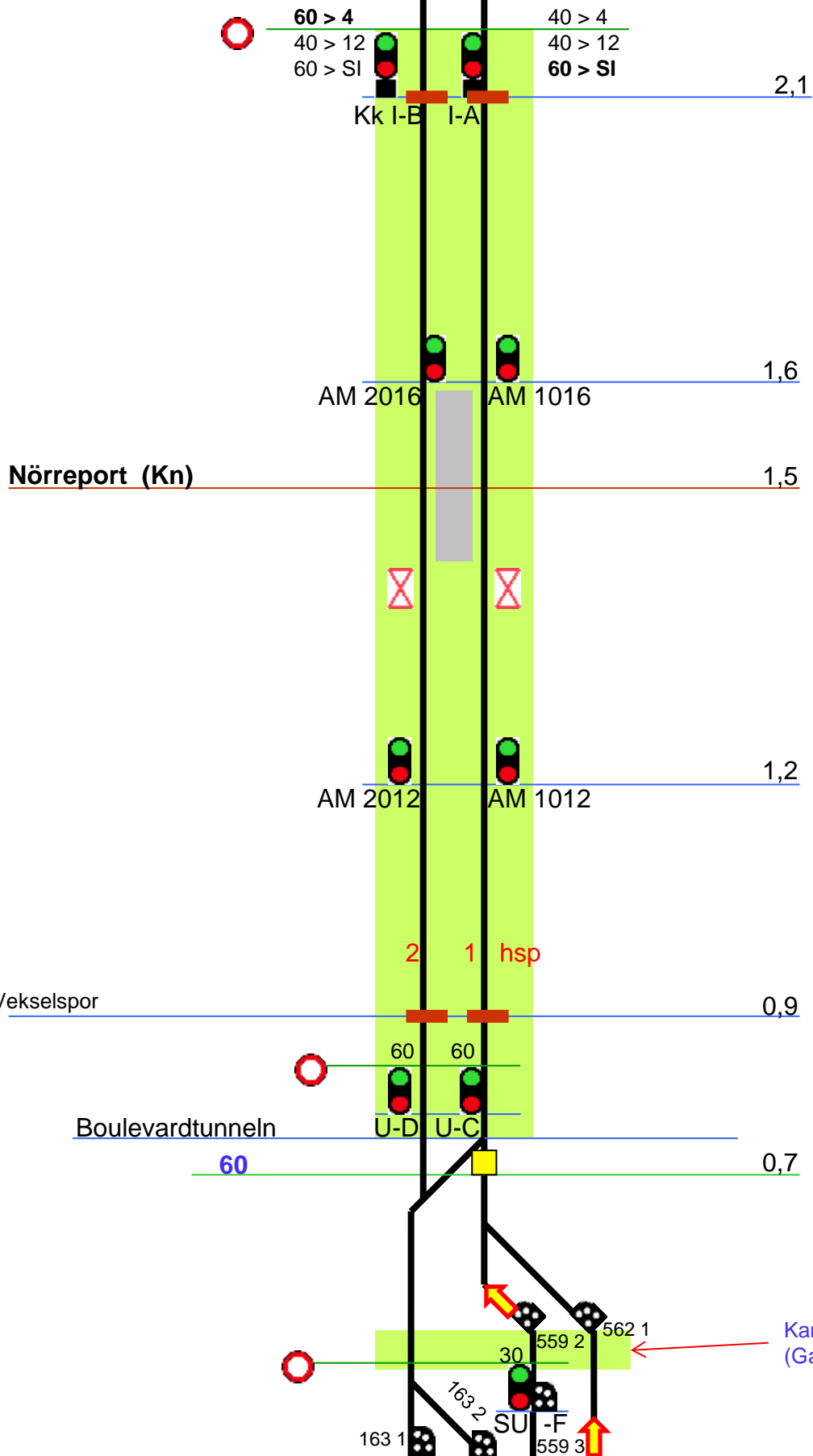

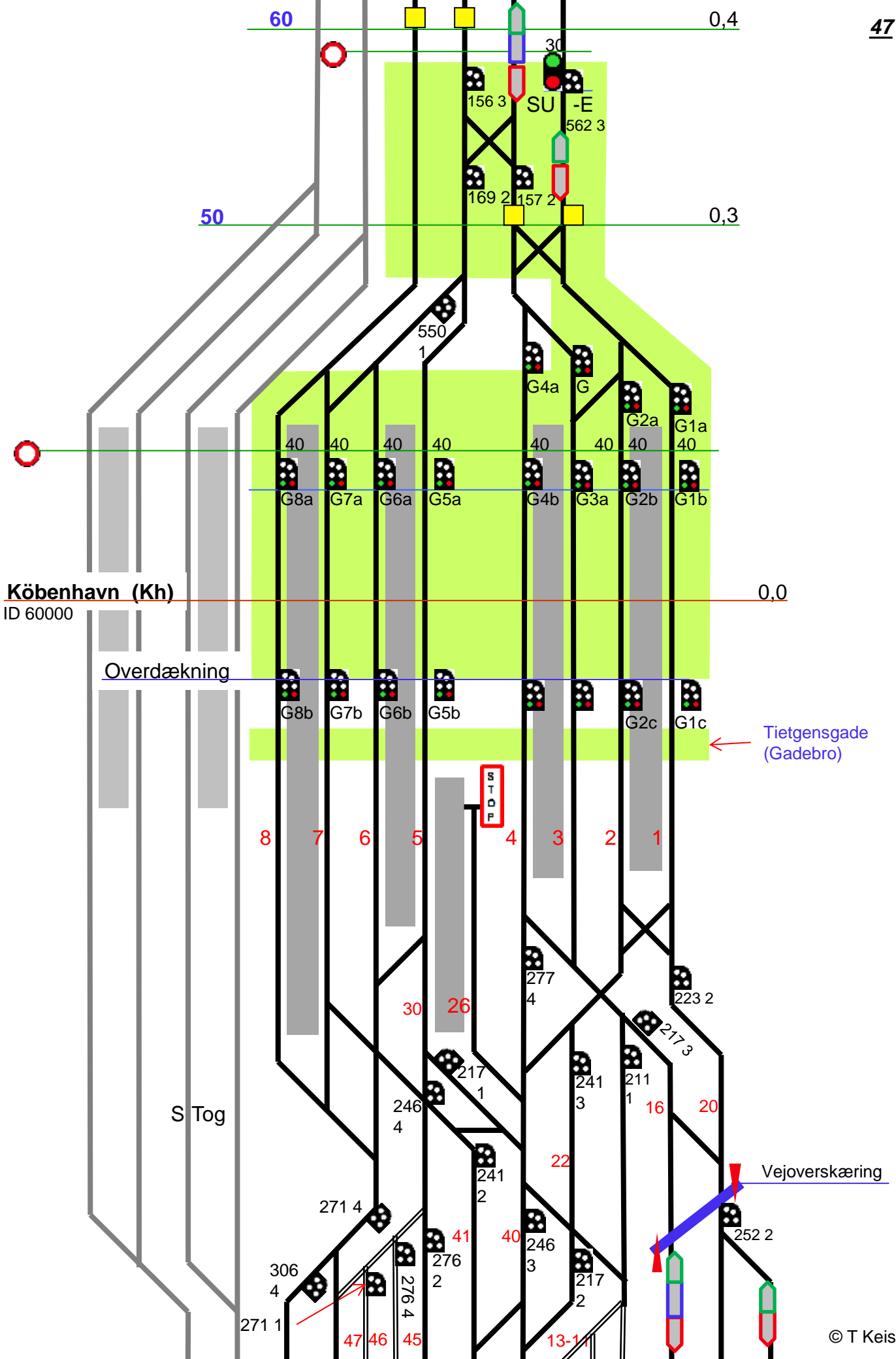

København (Kh)
ID 60000

Overdækning

S Tog

Tietgensgade
(Gadebro)

Vejoverskæring

STOP

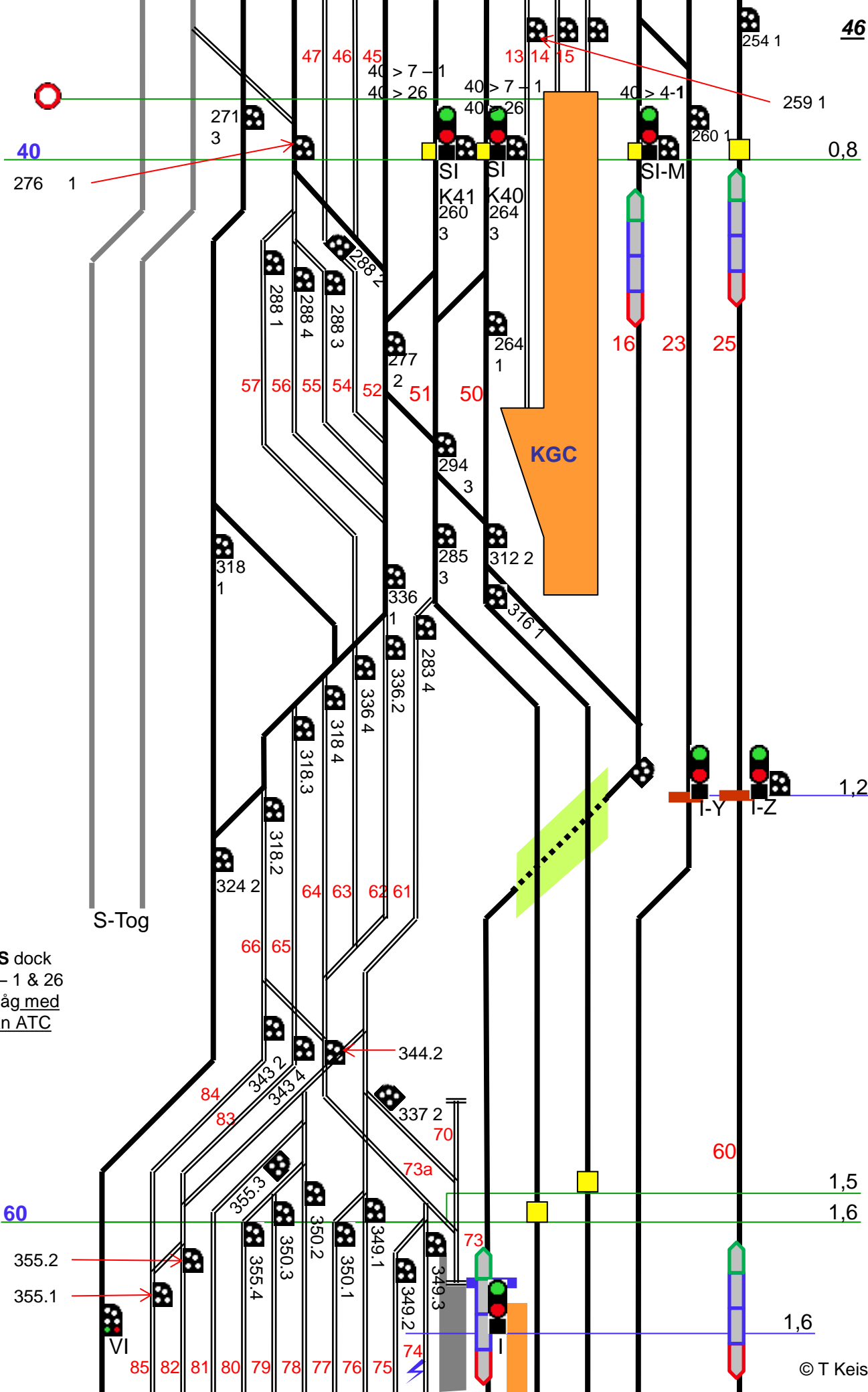

Vid **TUS** dock
 30 > 8 - 1 & 26
 Gäller tåg med
 och utan ATC

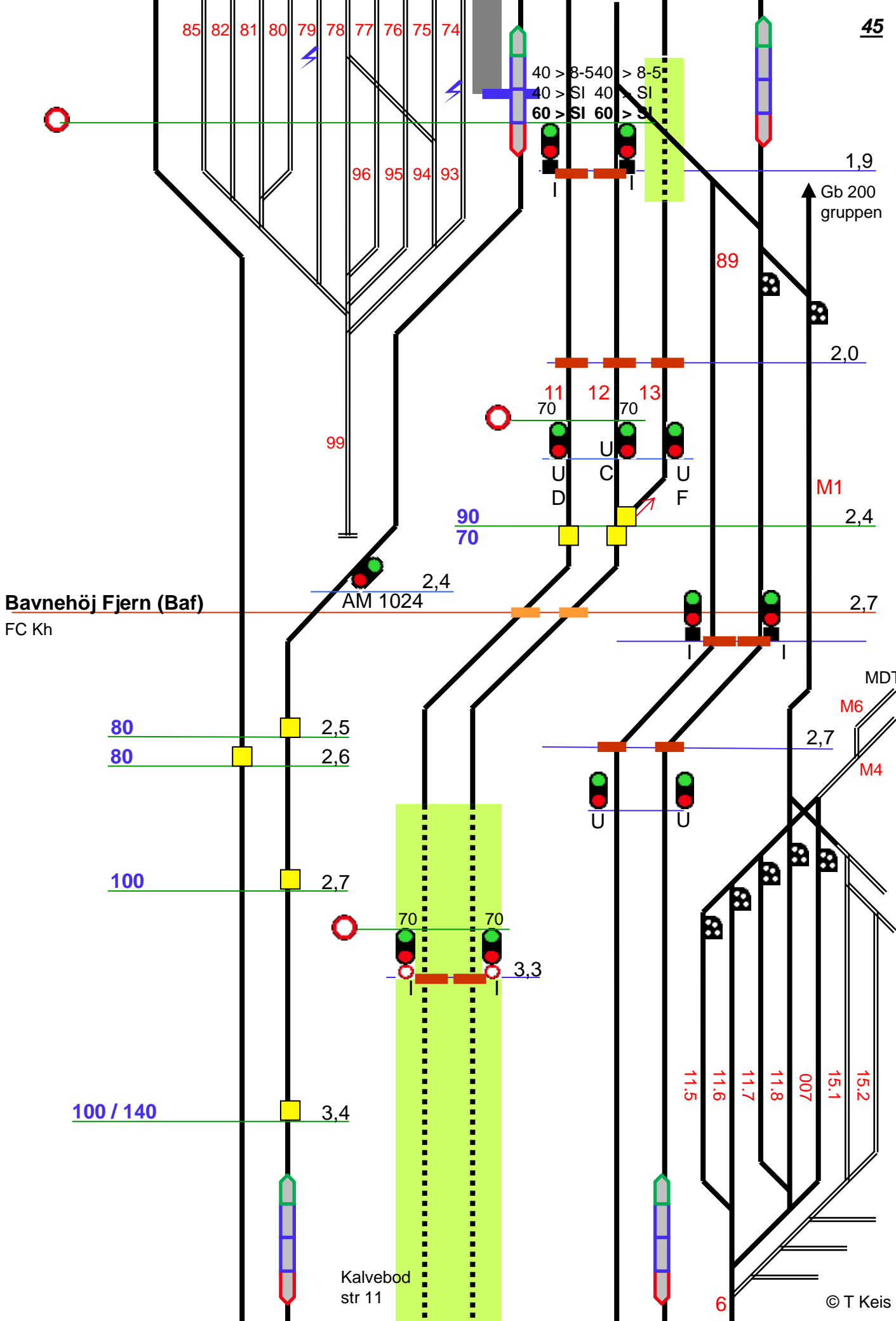

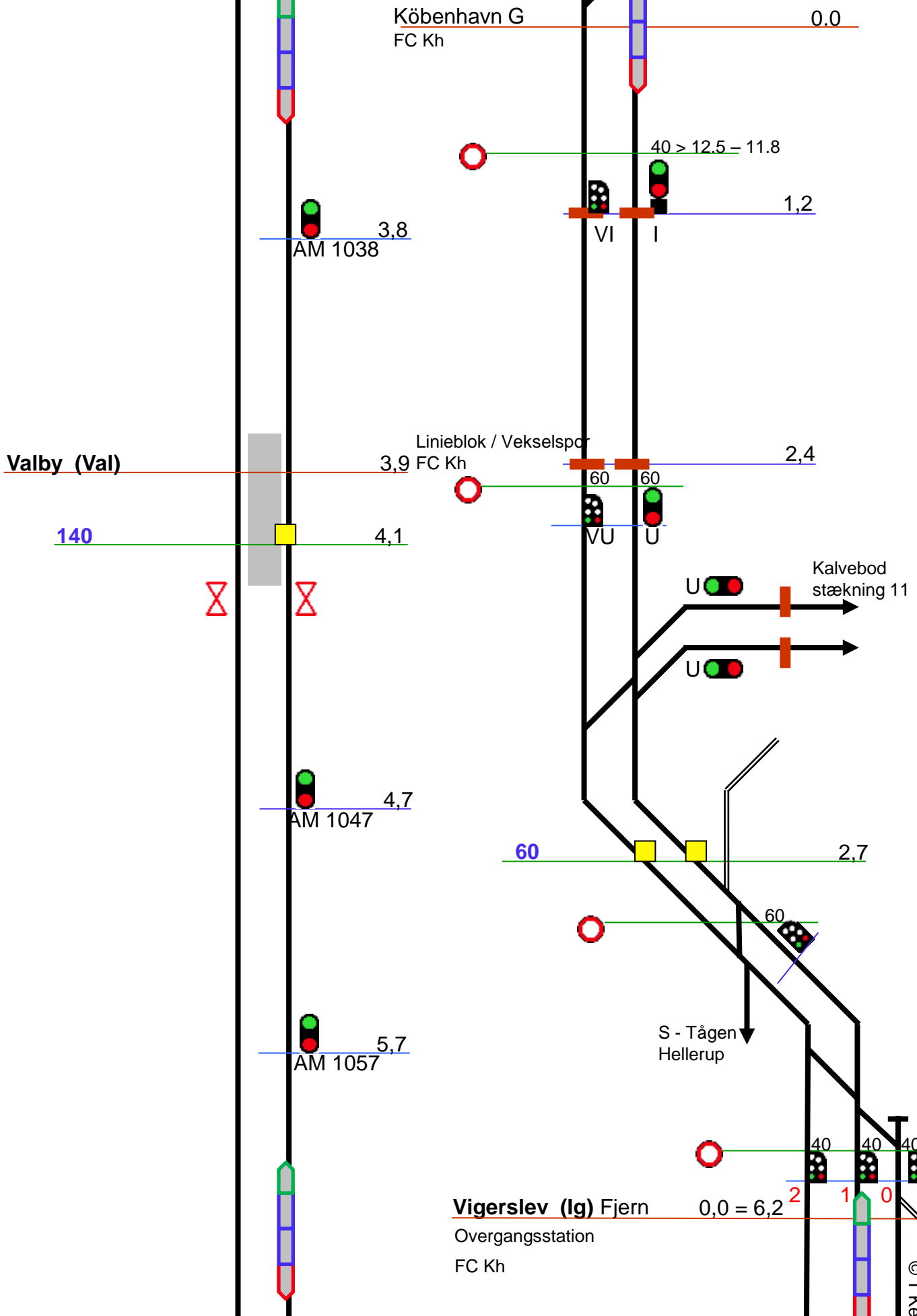

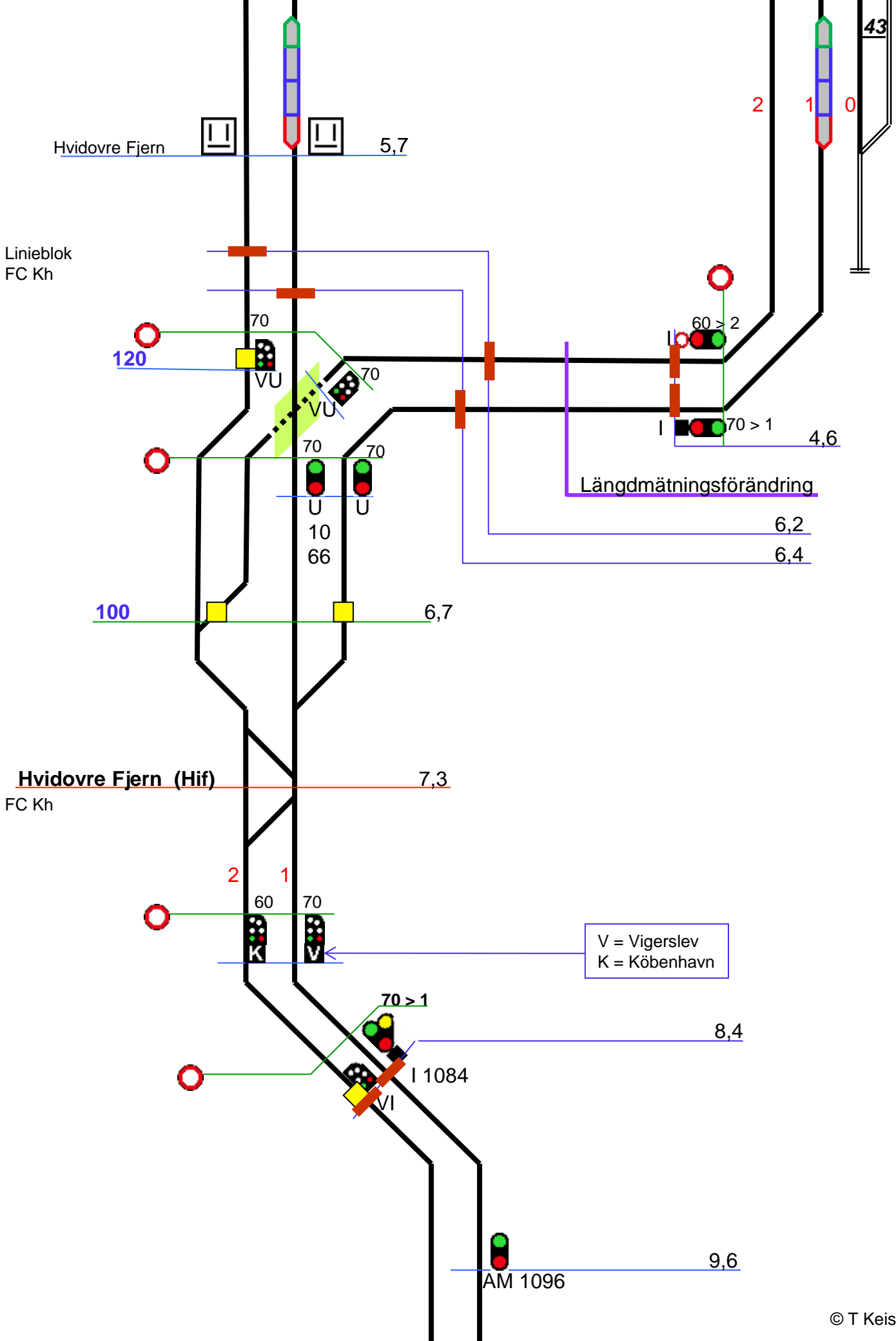

FC Kh

Glostrup (GI)
ID 60001

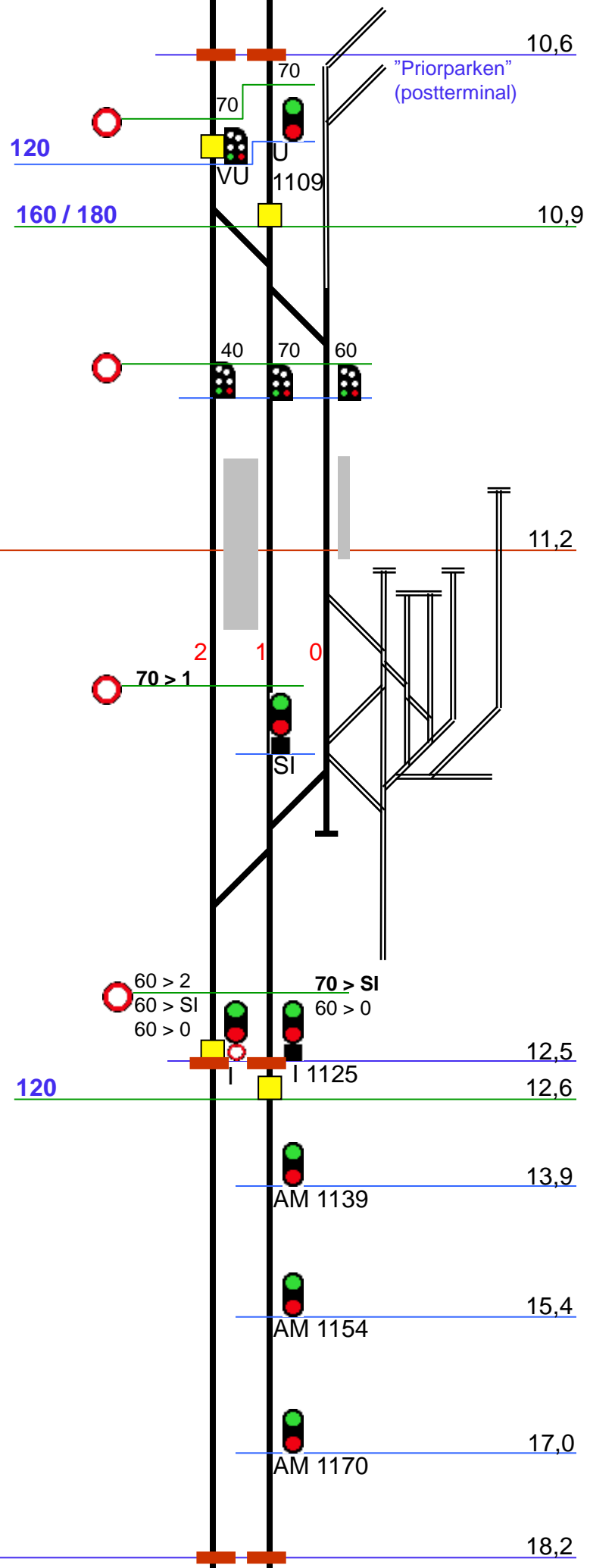

S - Tog
str 8.2
Köbenhavn H

120

70

70

VU

U 1184

160 / 180

18,5

100

19,1

60

60

60

70

70

60

Höje Taastrup (Htå)

19,5

Overgangsstation

FC Ro Øst ID 61001

5

4

3

2

1

0

120

20,7

Kombiterminal

	> 5	4	3	2	1	0
hsp 4	60	70	60	60	60	60
hsp 3	60	60	70	60	60	60
hsp 2	60	60	60	70	60	60
hsp 1	60	60	60	60	70	60

N4

N3

N2

N1

21,0

4

3

2

1

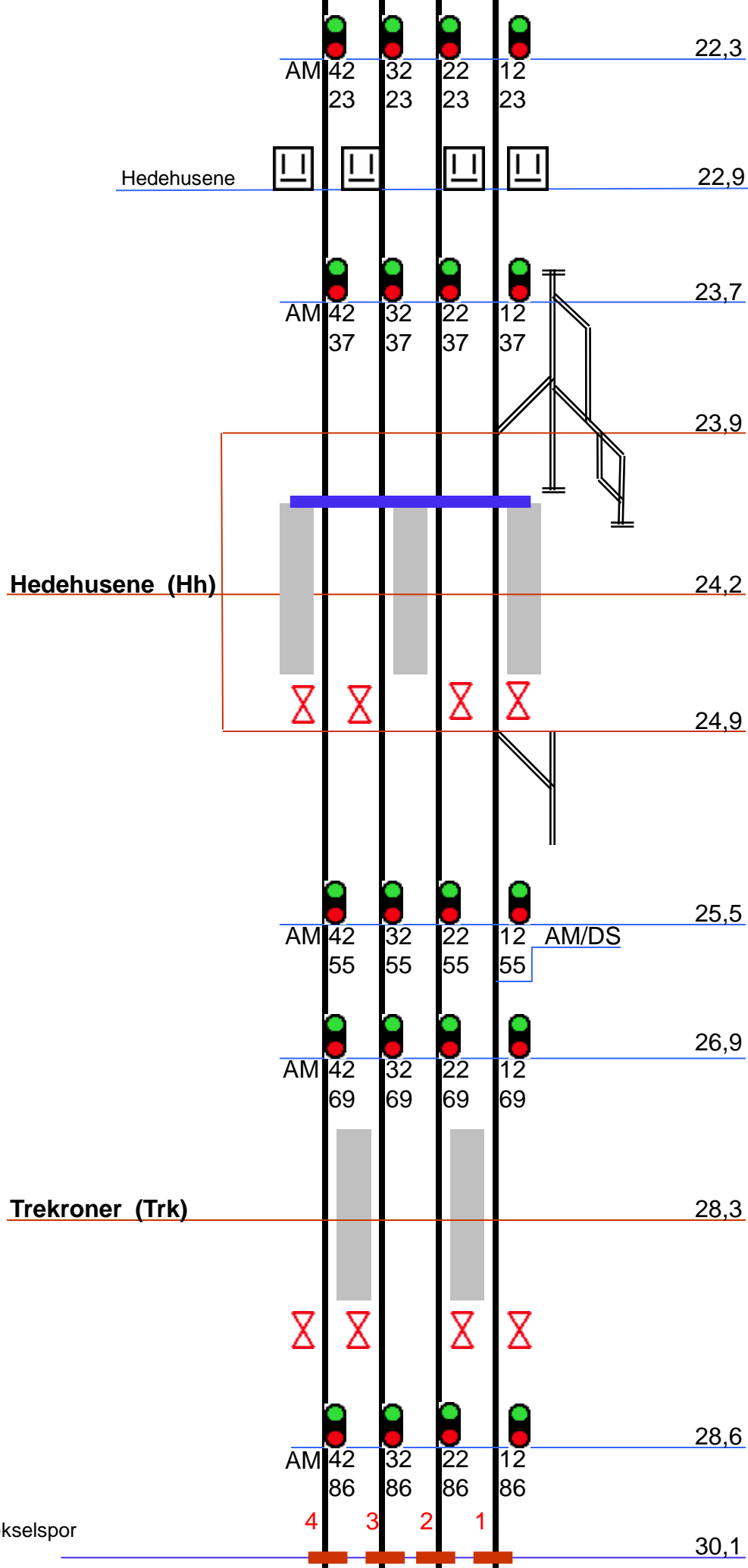

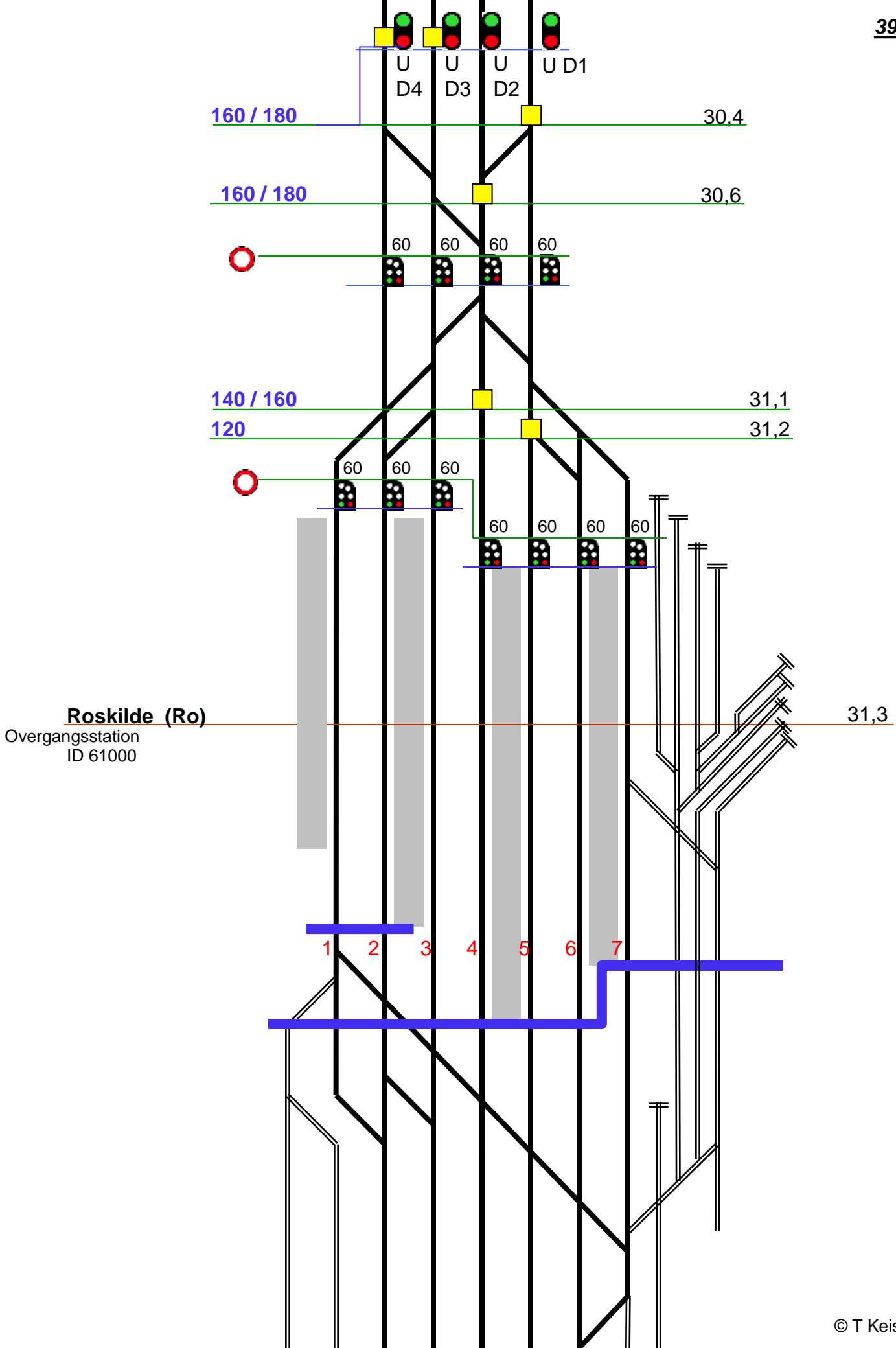

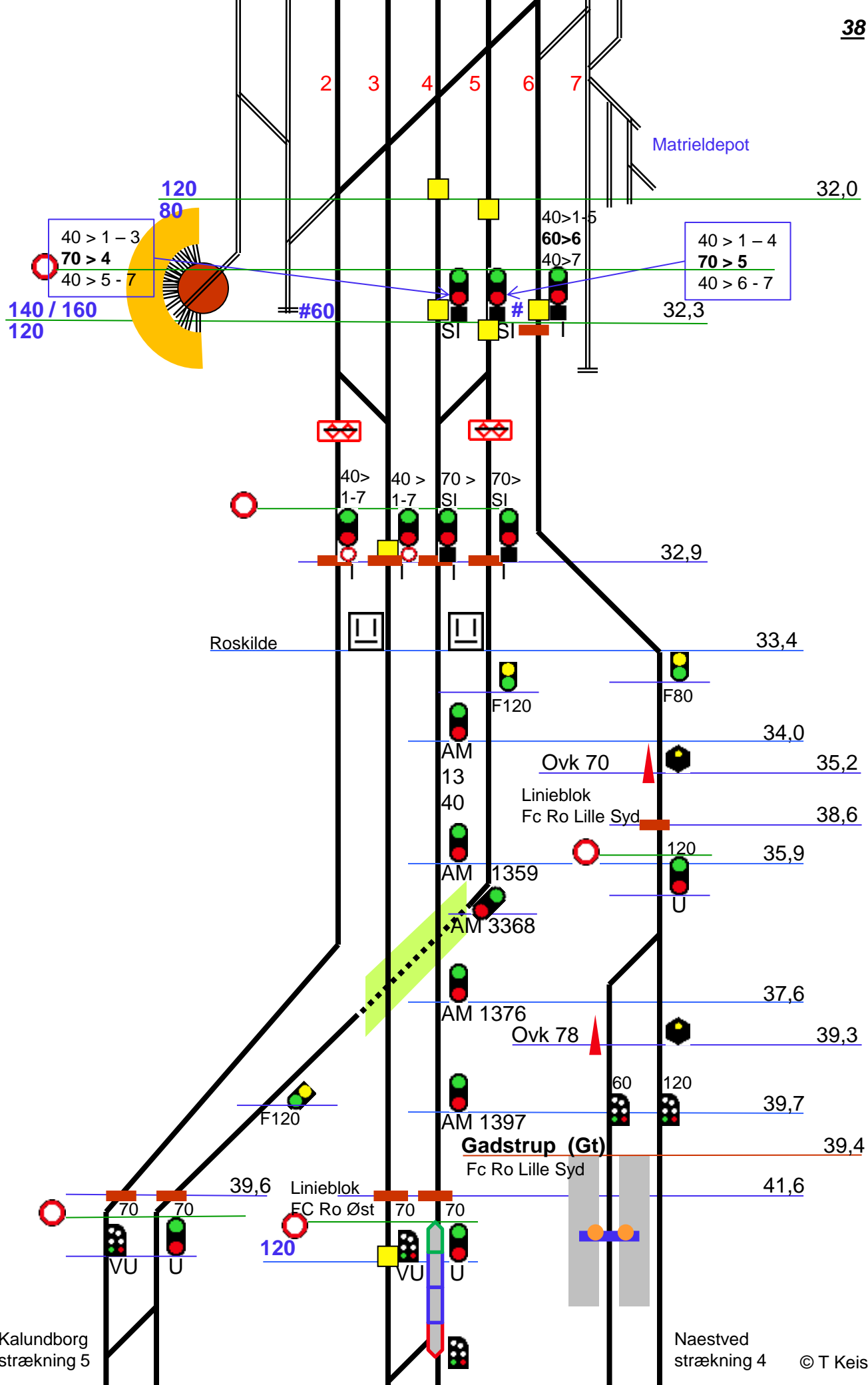

Kalundborg strækning 5

Næstved strækning 4

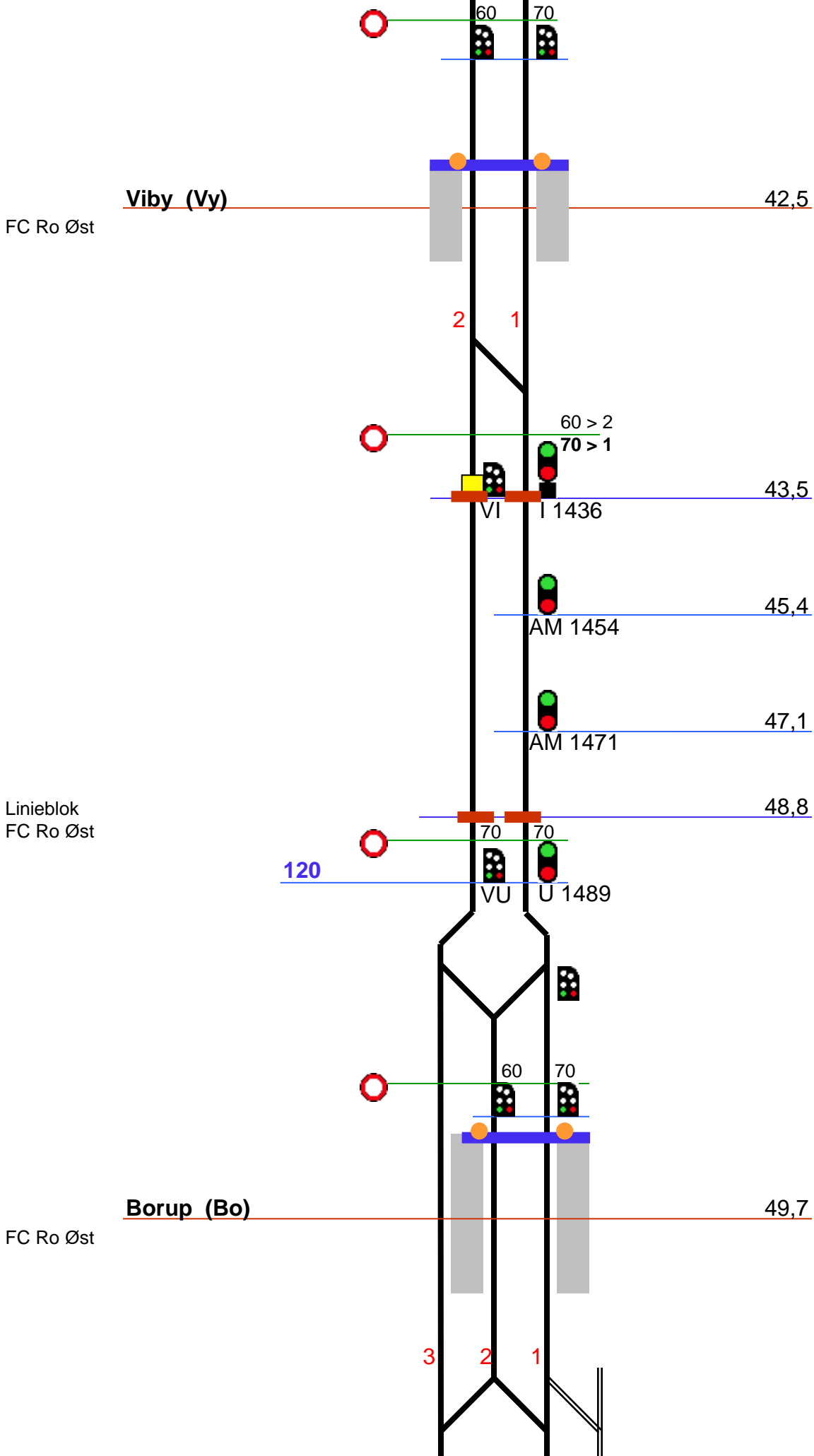

Linieblok
FC Ro Øst

FC Ro Øst

Linieblok
FC Ro Øst

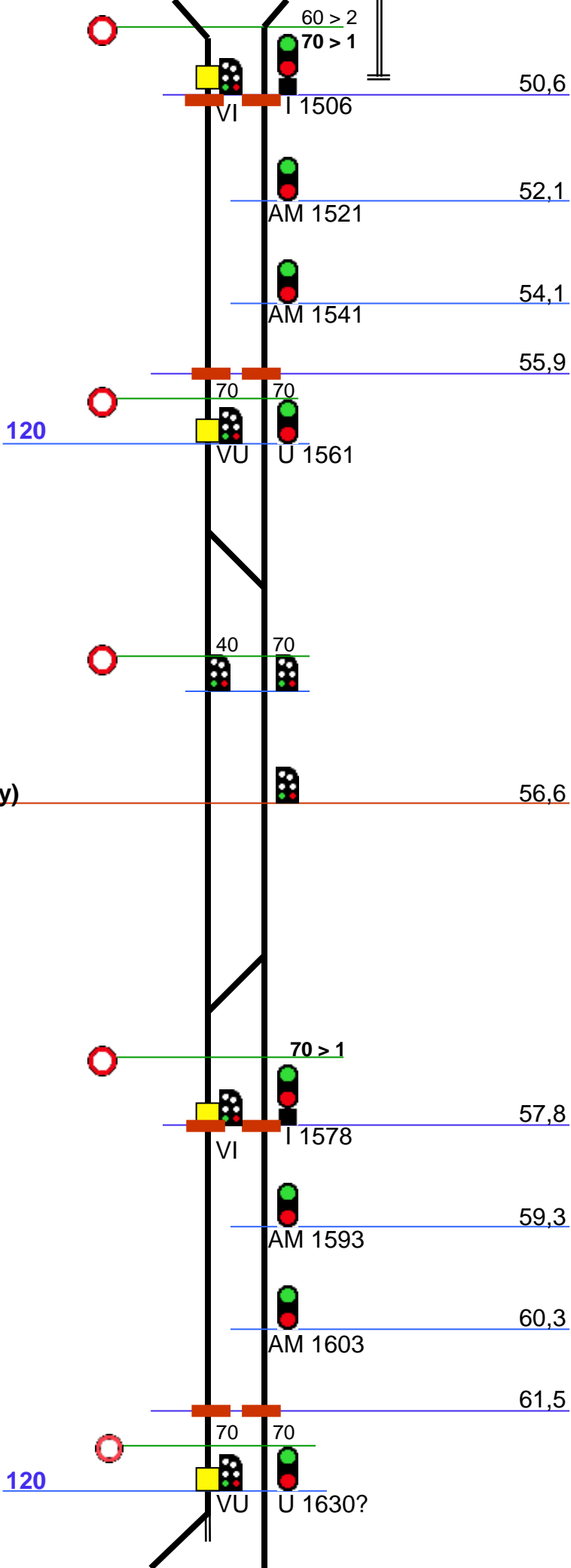

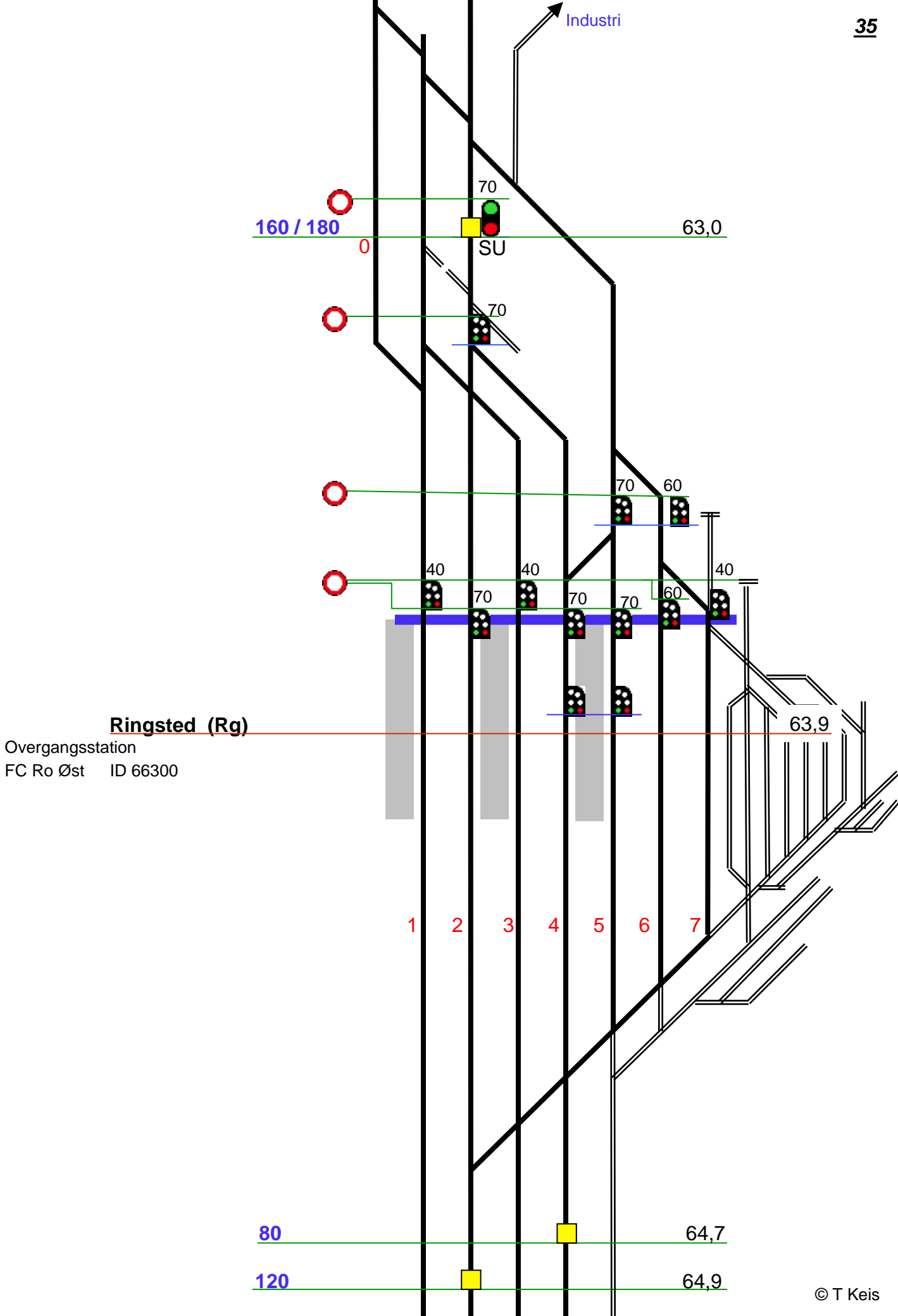

Ringsted (Rg)

Overgangsstation
FC Ro Øst ID 66300

Linieblok
FC Ro Vest

FC Ro Vest

Fjenneslev (Fj)

Glumsø (Gz)

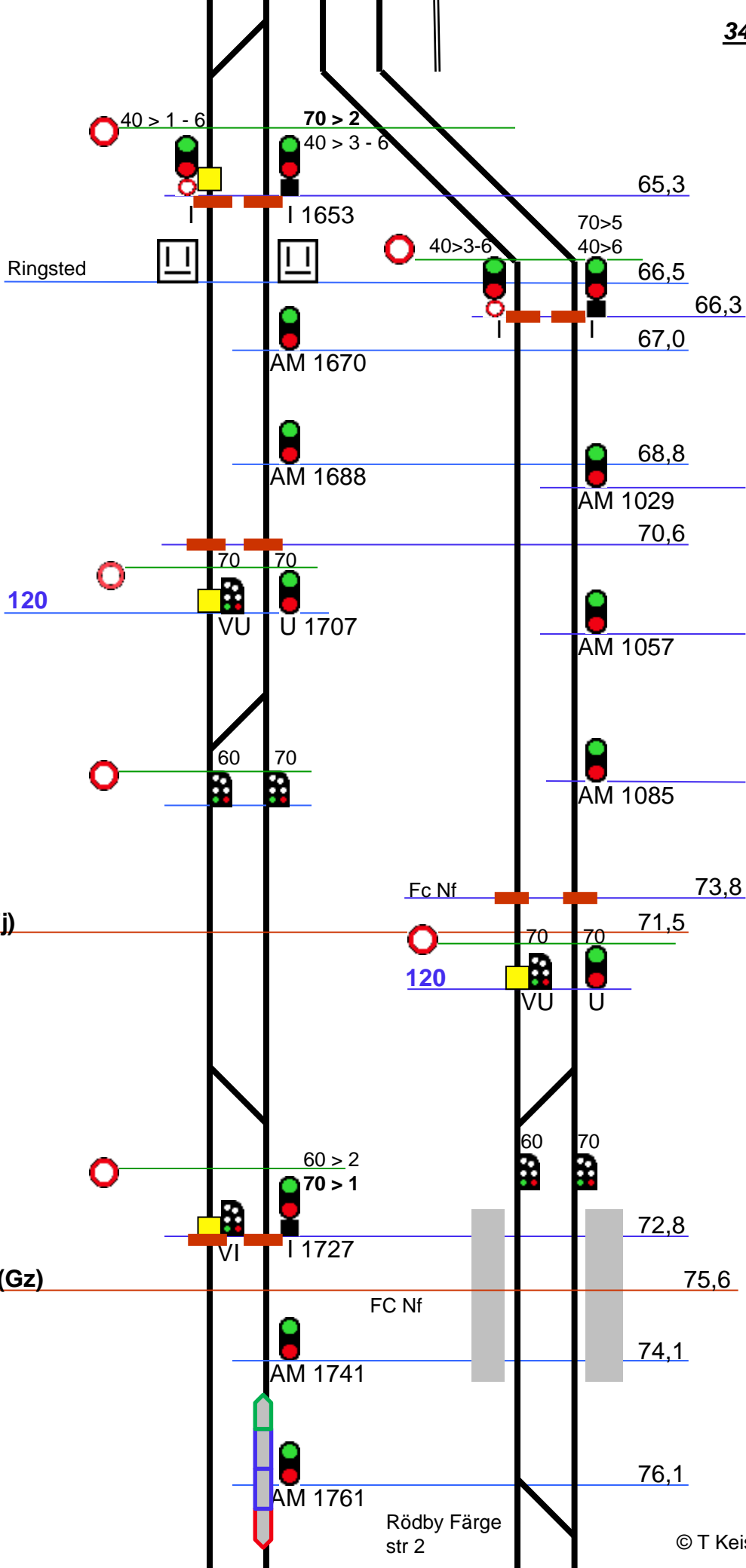

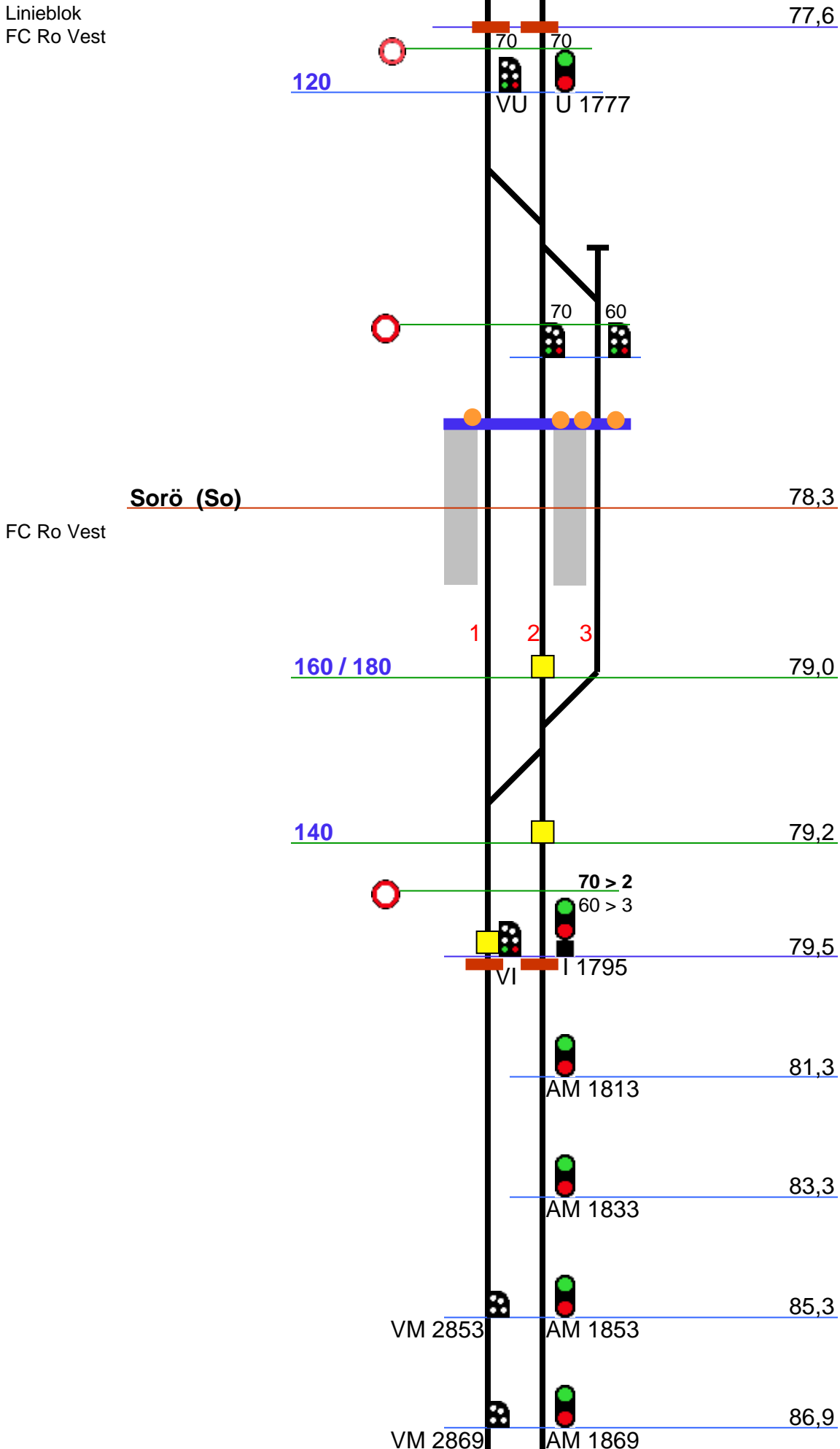

Linieblok
FC Ro Vest

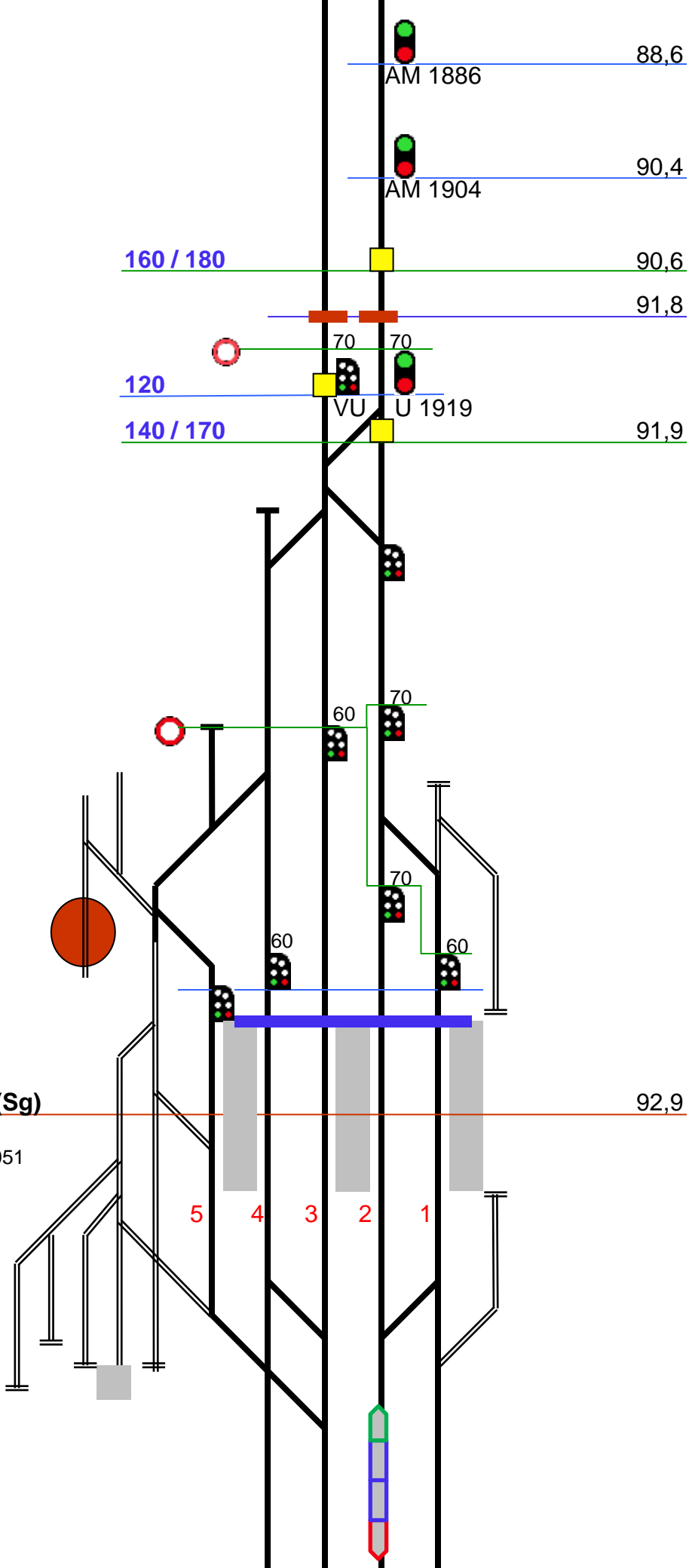

88,6

AM 1886

90,4

AM 1904

160 / 180

90,6

91,8

120

70

70

140 / 170

VU

U 1919

91,9

60

70

70

60

60

Slagelse (Sg)

92,9

Overgangsstation
FC Ro Vest ID 61051

5

4

3

2

1

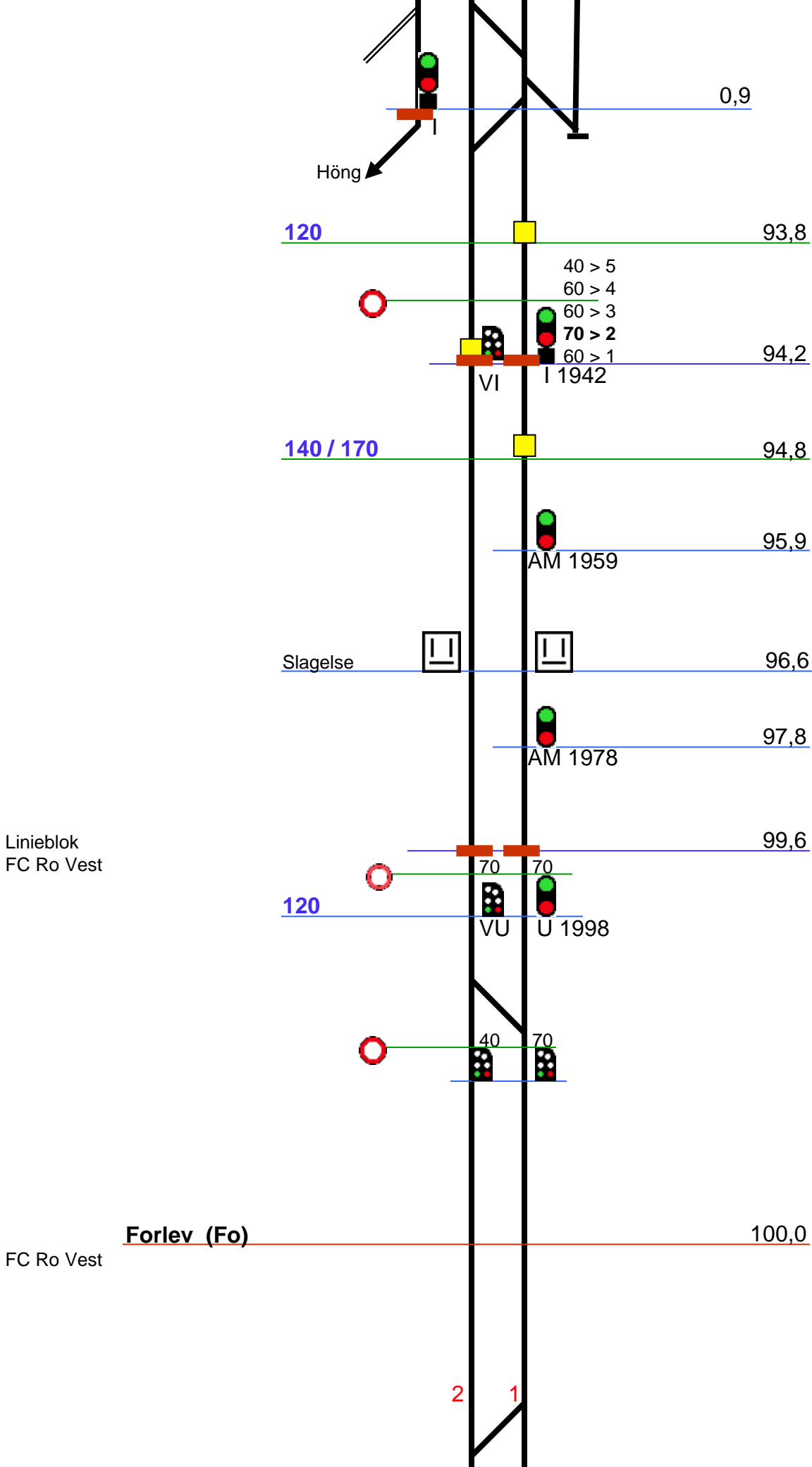

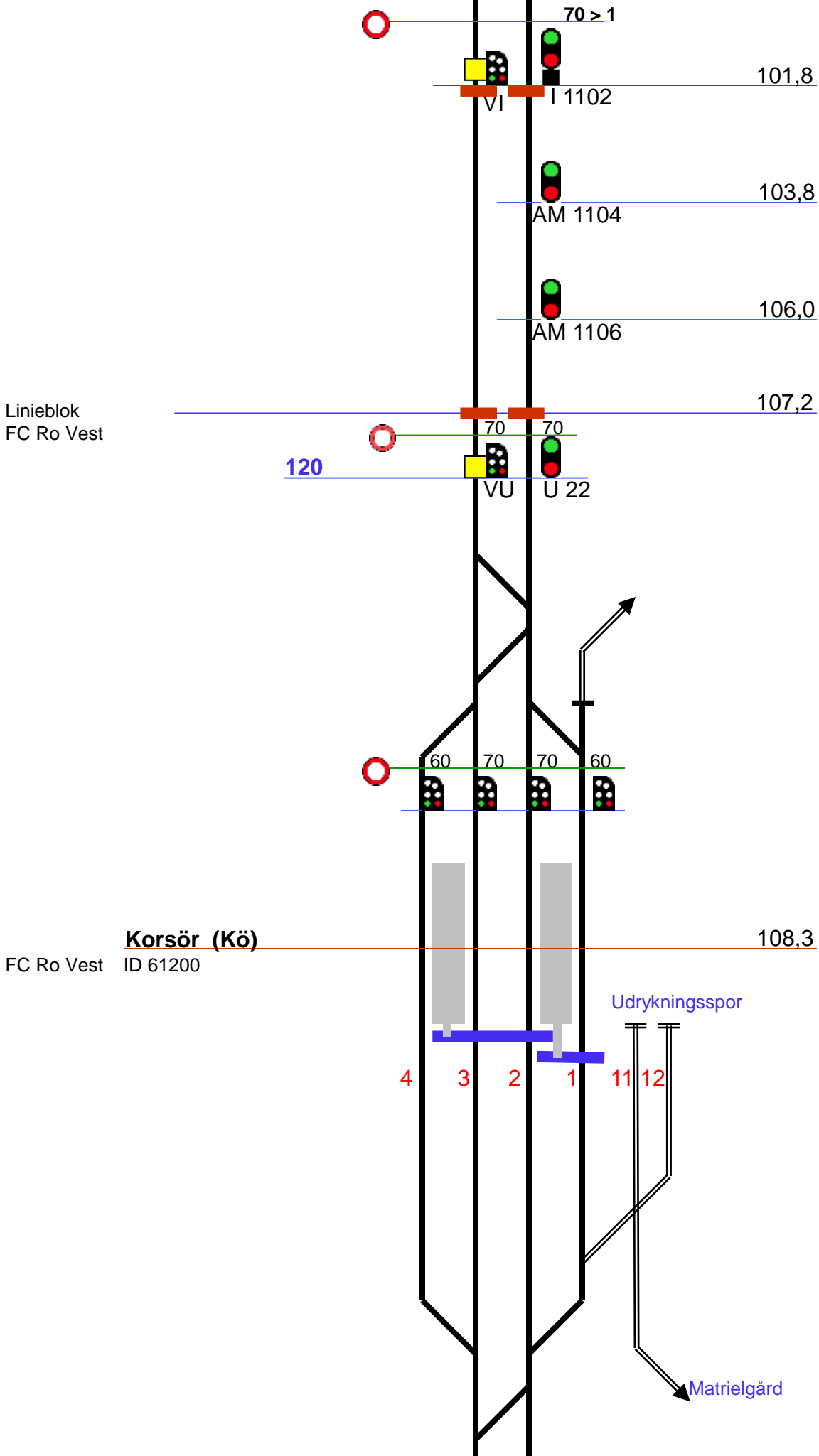

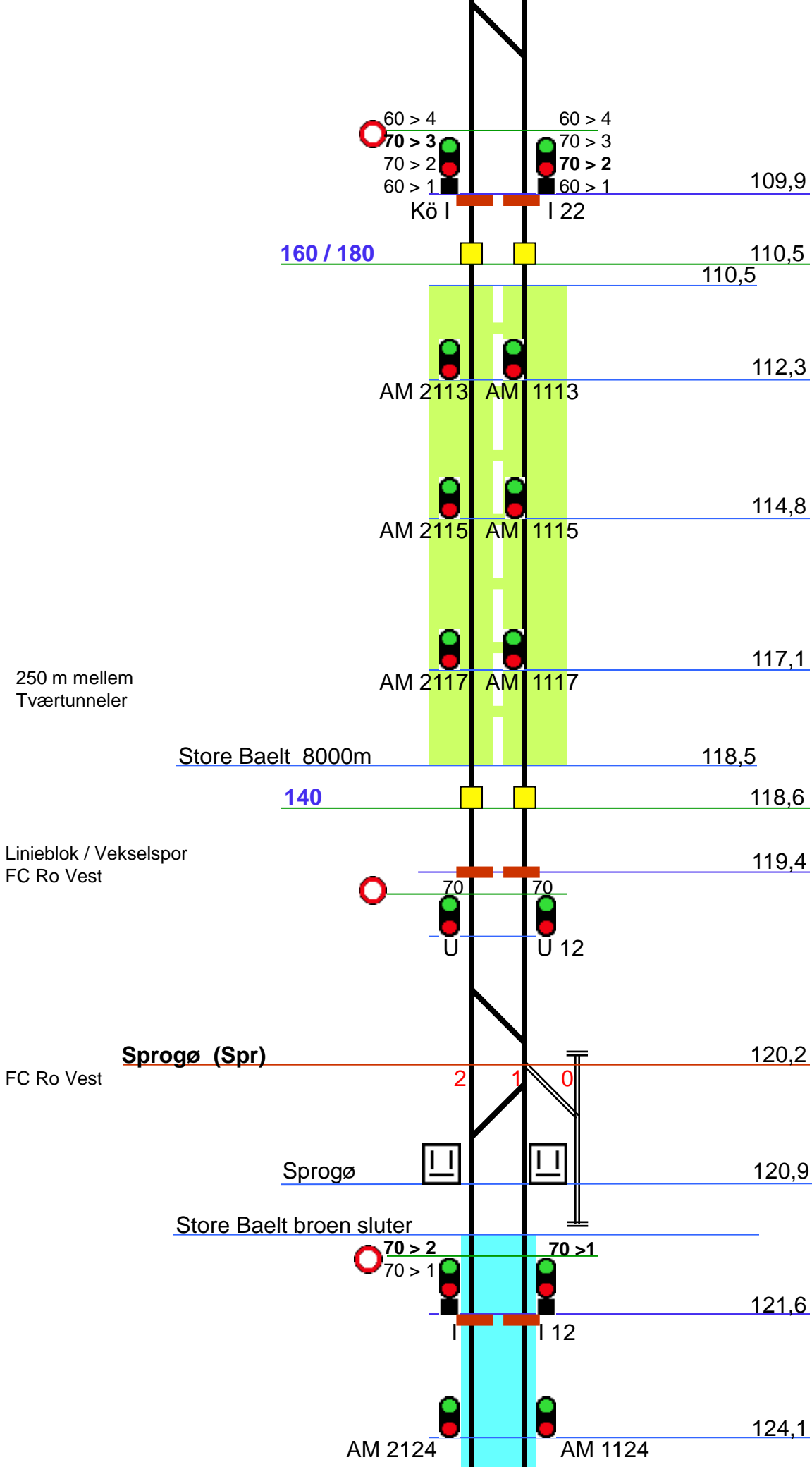

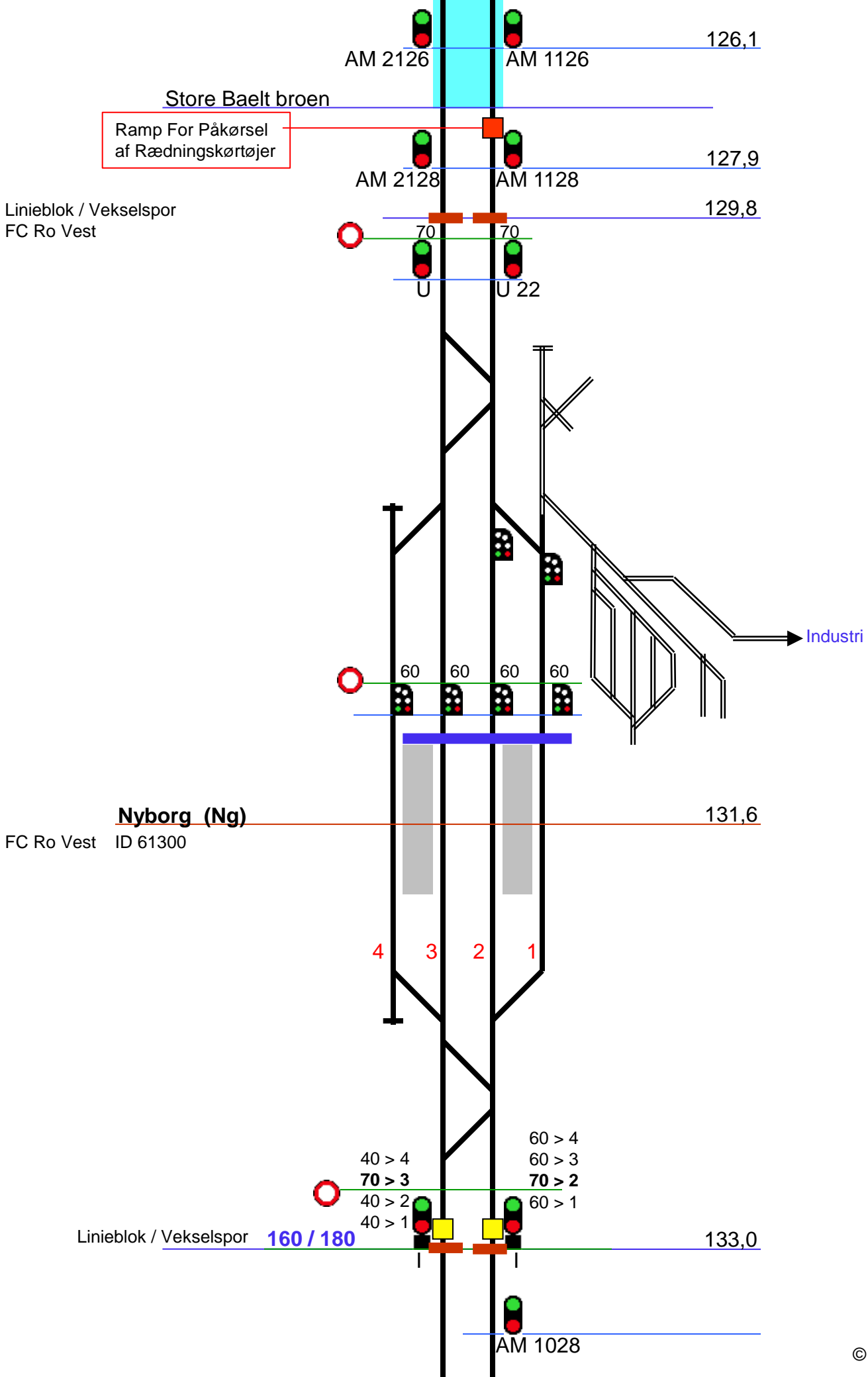

Linieblok
FC Ro Vest

135,6

120



70



VU

70



U 1045

Hjulby (Ju)

136,6

FC Ro Vest

1

2



70 > 2



VI



I 1059

137,2



AM 1079

139,2

Linieblok
FC Ro Vest

141,0

120



70



VU

70



U 1189



70



50



Ullerslev (Uv)

141,5

FC Ro Vest

1

2

3

Linieblok
FC Ro Øst

FC Ro Vest

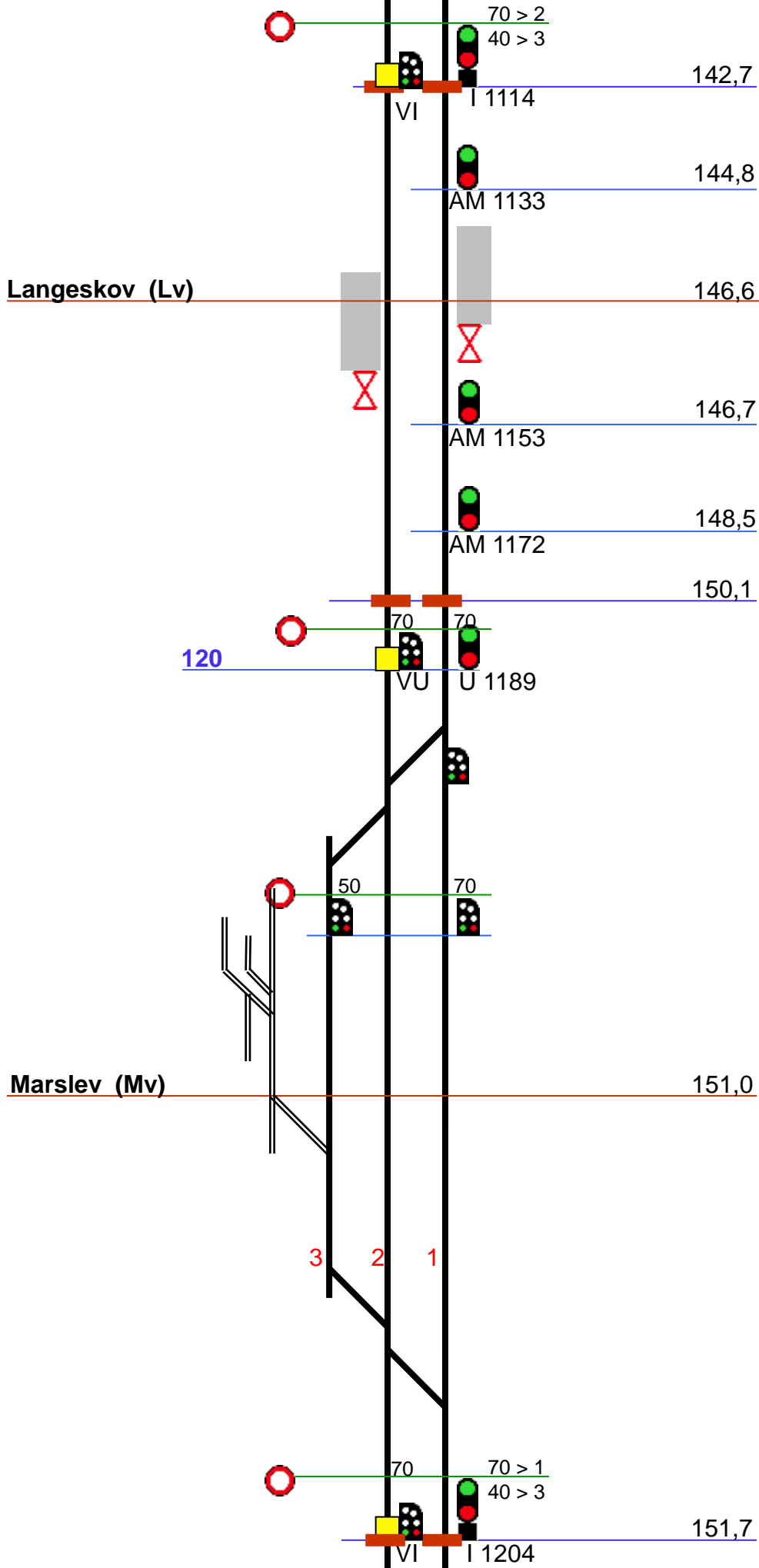

Marslev



153,1

153,7



AM 1224

155,7



AM 1244

157,7



AM 1264

Kaertemindesporet

Linieblok
FC Ro Vest

160 / 180

159,6



70

70

120

VU

U

1284

70

40

60

40

40

Odense (Od)

160,3

Overgangsstation
ID 66800

8

7

6

5

4

3

2

1

21

22

23

24

25

26

27

28

Jernbanemuseum

21 22 23 24 25 26 27 28

8 7 6 5 4 3 2 1

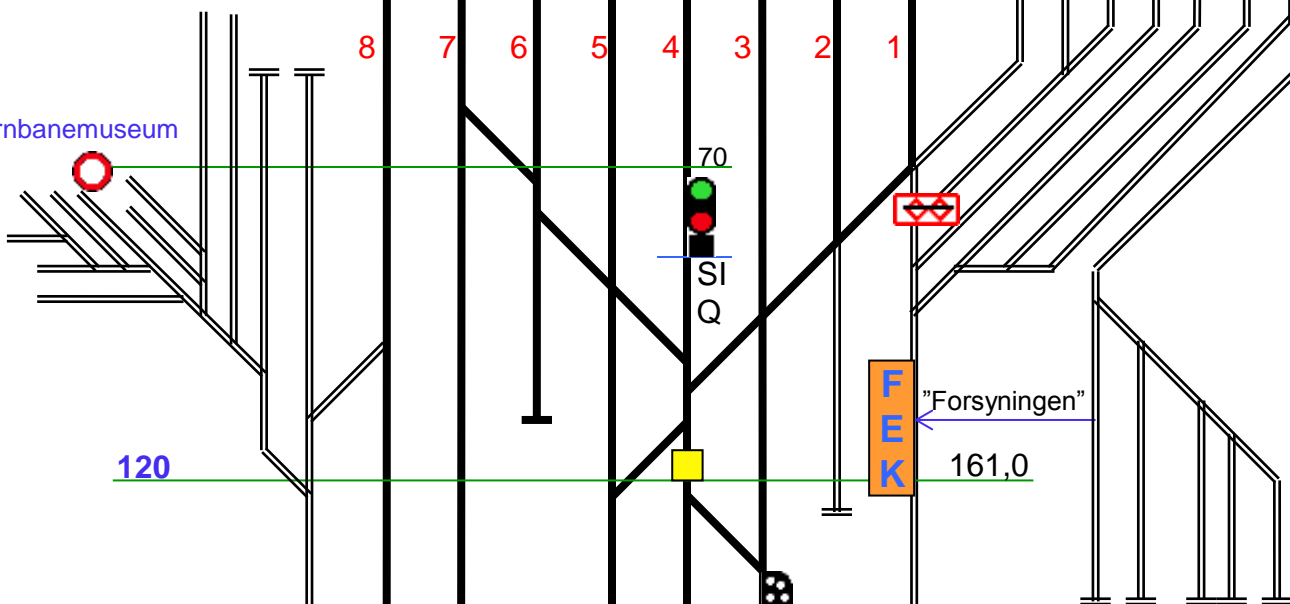

120

"Forsyningen"

161,0

40 > 7
 40 > 6
70 > SI
 40 > 3
 40 > 2

70 > 8
 70 > 7
 40 > 6

161,8

100 / 110

161,9

90

1,5

F56

AM 1316

"Hullet"

140 / 160

162,9

AM 1336

Odense Sugehus (Oss)

AM 1356

3,8

Linieblok
FC Fa

168,3

120

70 70

100

Svendborg
str 21

4,0

VU U

FC Fa

Holmstrup (Hp)

169,1

2 1

60 > 2
70 > 1

169,6

VI

AM 1399

AM 1419

140 / 170

173,9

Linieblok
FC Fa

174,6

120

VU

U

FC Fa

Tommerup (Tp)

175,5

3 2 1



70 > 2
60 > 1

176,3



VI

I



AM 1473

Skalbjerg (Sc)

178,8

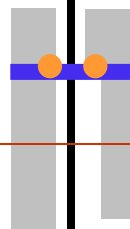

140 / 160

179,1



VM 2490

AM 1490

Bred (Bd)

181,1

Linieblok
FC Fa

183,4

Årup (Ap)

184,7

FC Fa

120



VM 2506



U



70



60

2

1

3



1a

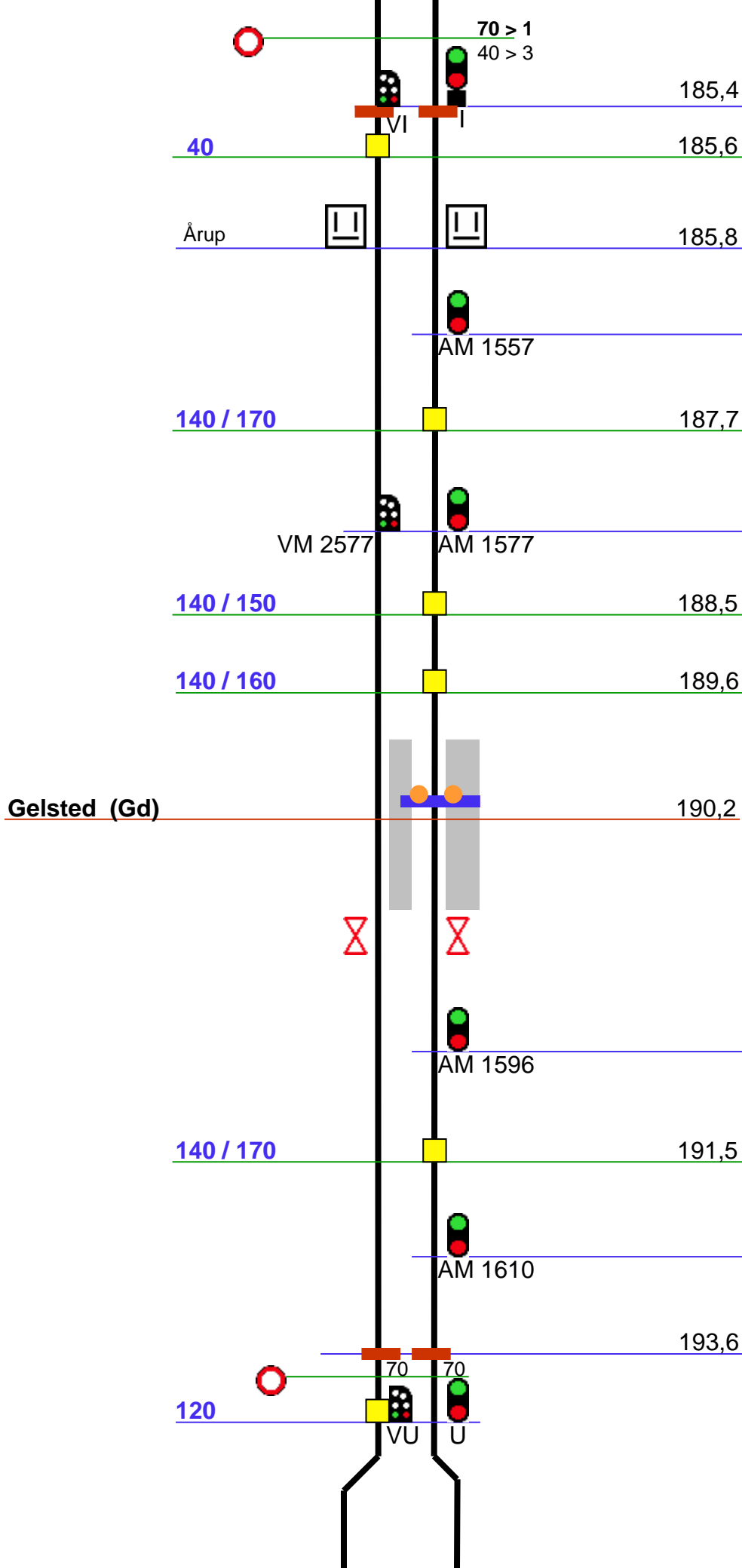

Linieblok
FC Fa

FC Fa

Ejby (Eb)

194,8

3 2 1

195,4

60 > 2
70 > 1

AM 1658

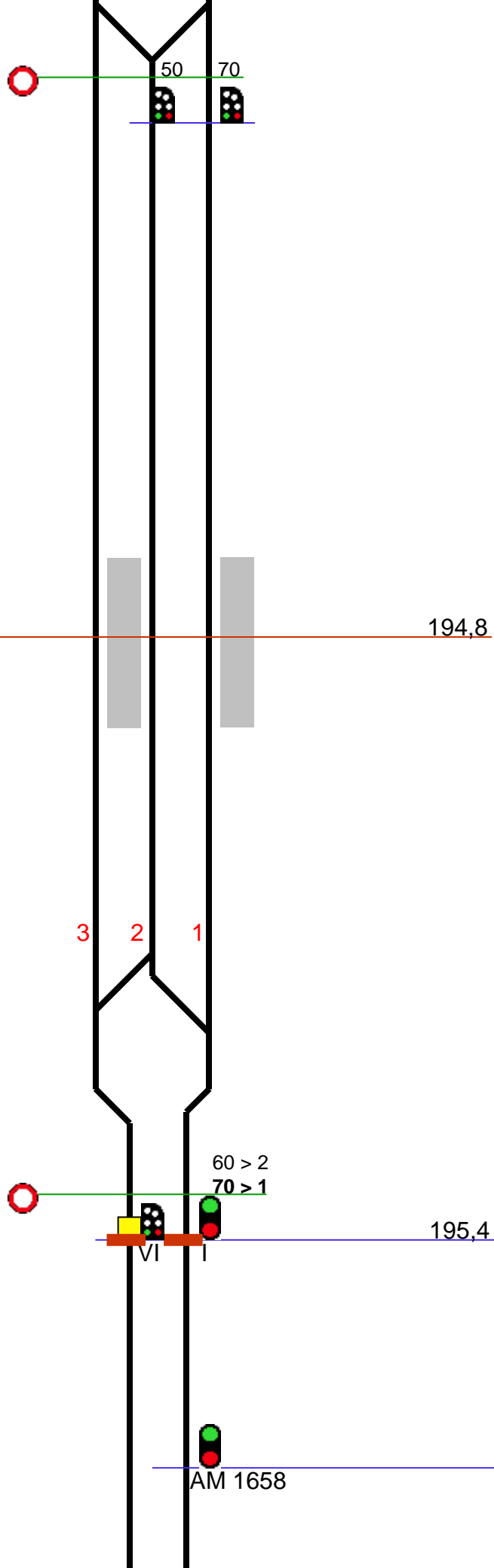

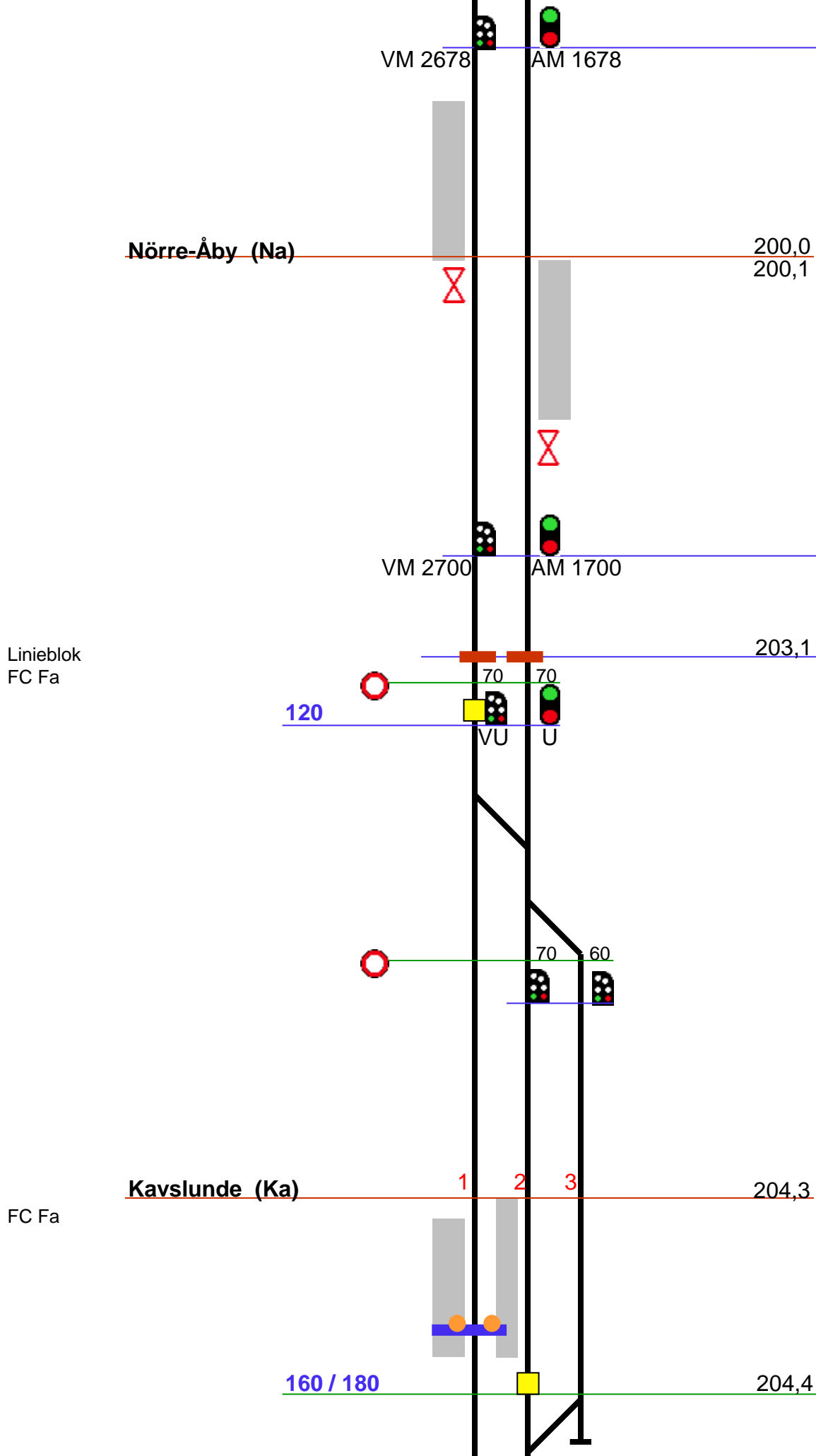

Linieblok
FC Fa

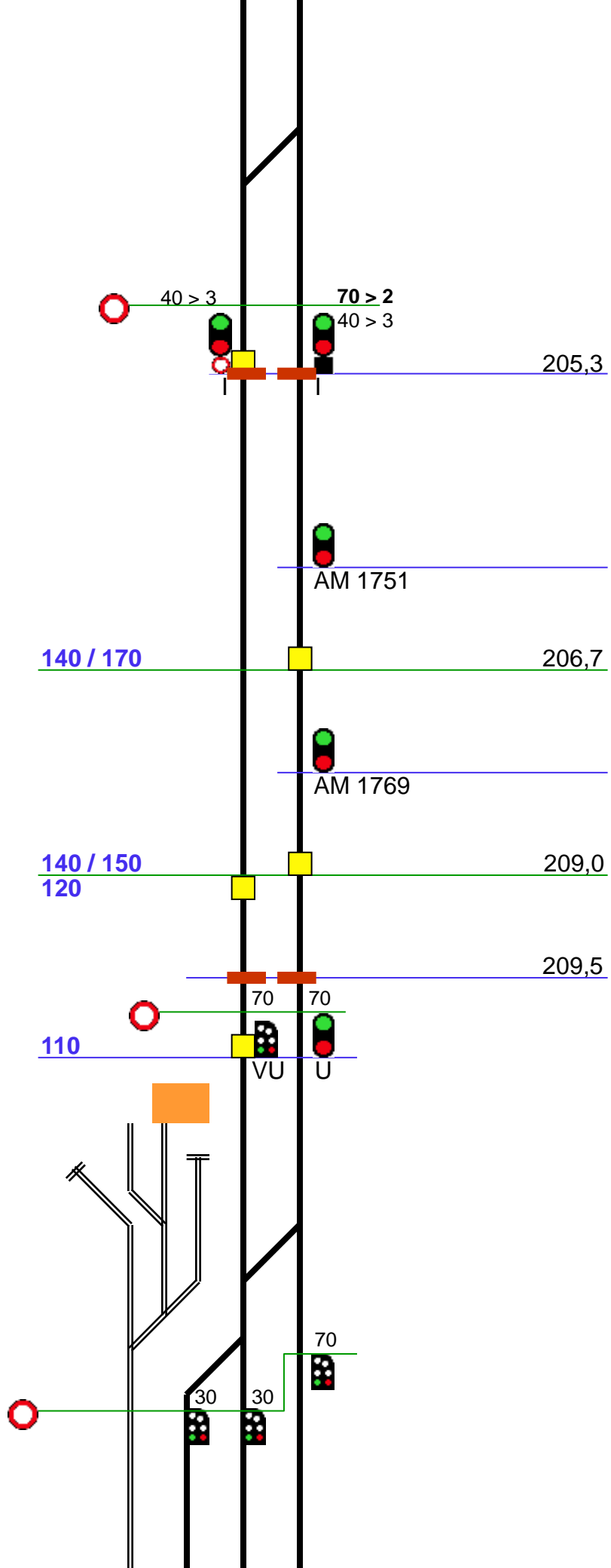

120 / 130

209,8

Middelfart (Md)

ID 67900

210,4

FC Fa

110 / 130

210,6

1

3

4



40 > 1
40 > 2



40 > 1
40 > 3
70 > 4



211,2

Lille Baelt broen sluter

Lille Baelt broen



AM 1820

120 / 130

213,2

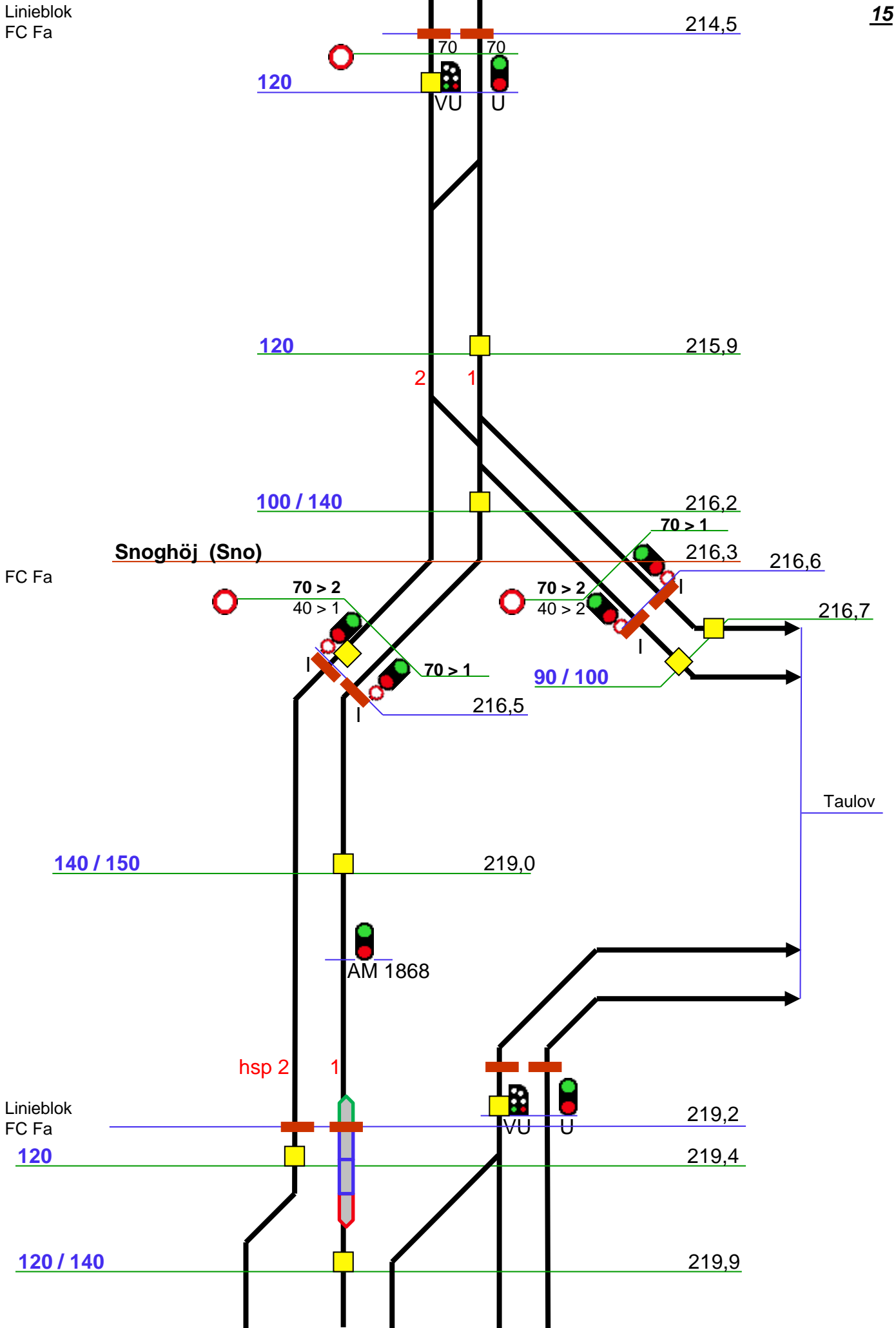

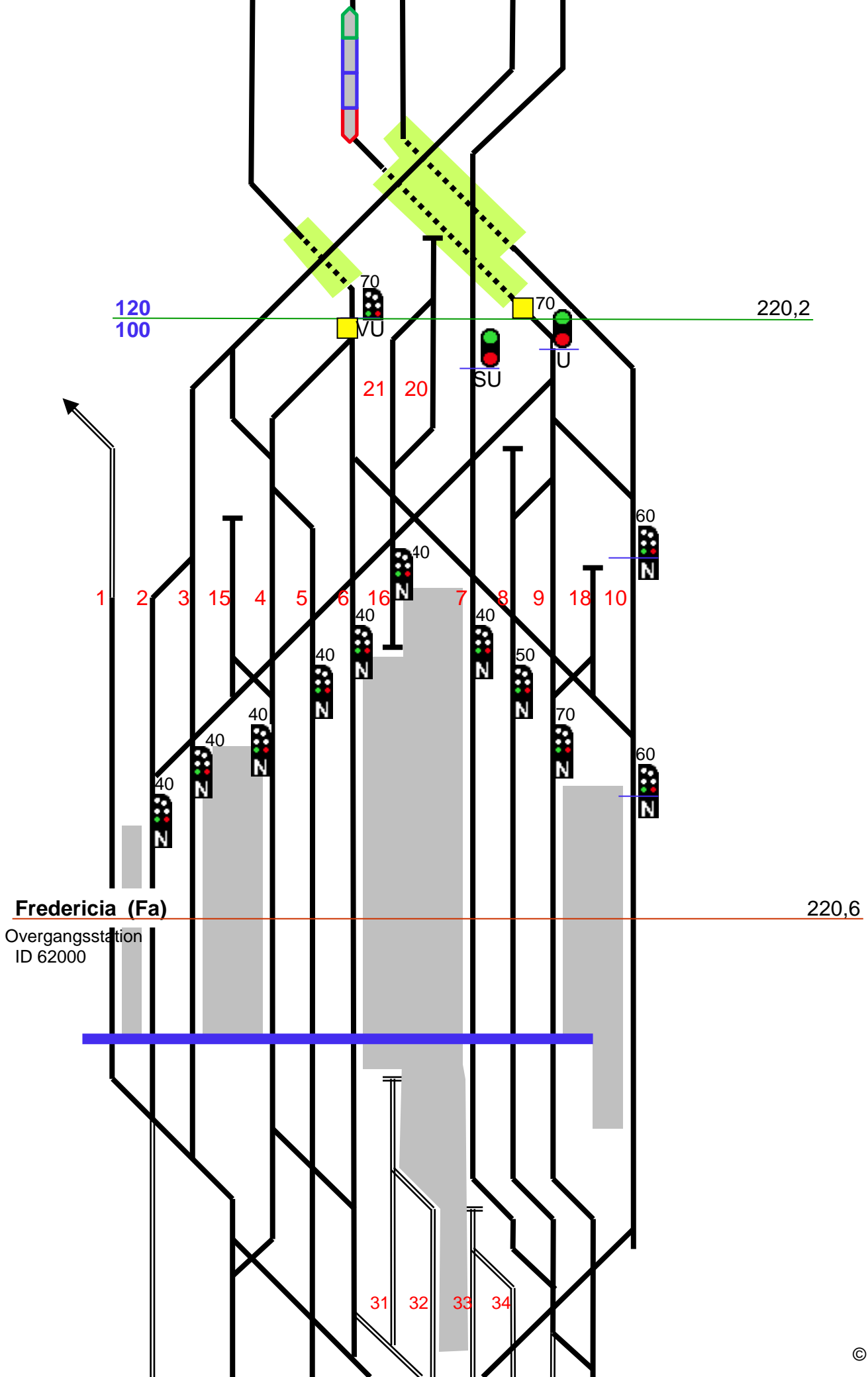

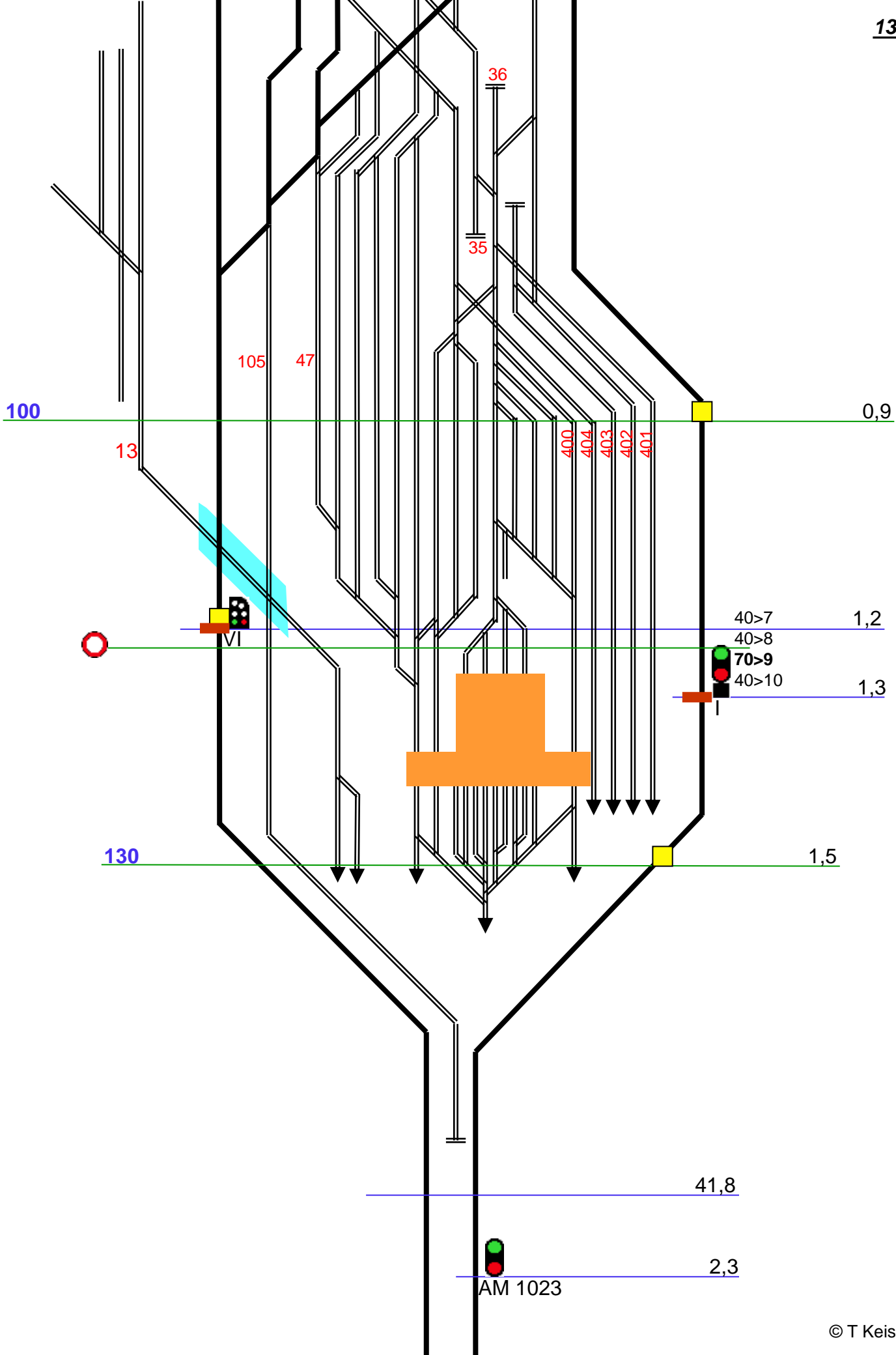

Linieblok
FC Fa

FC Fa

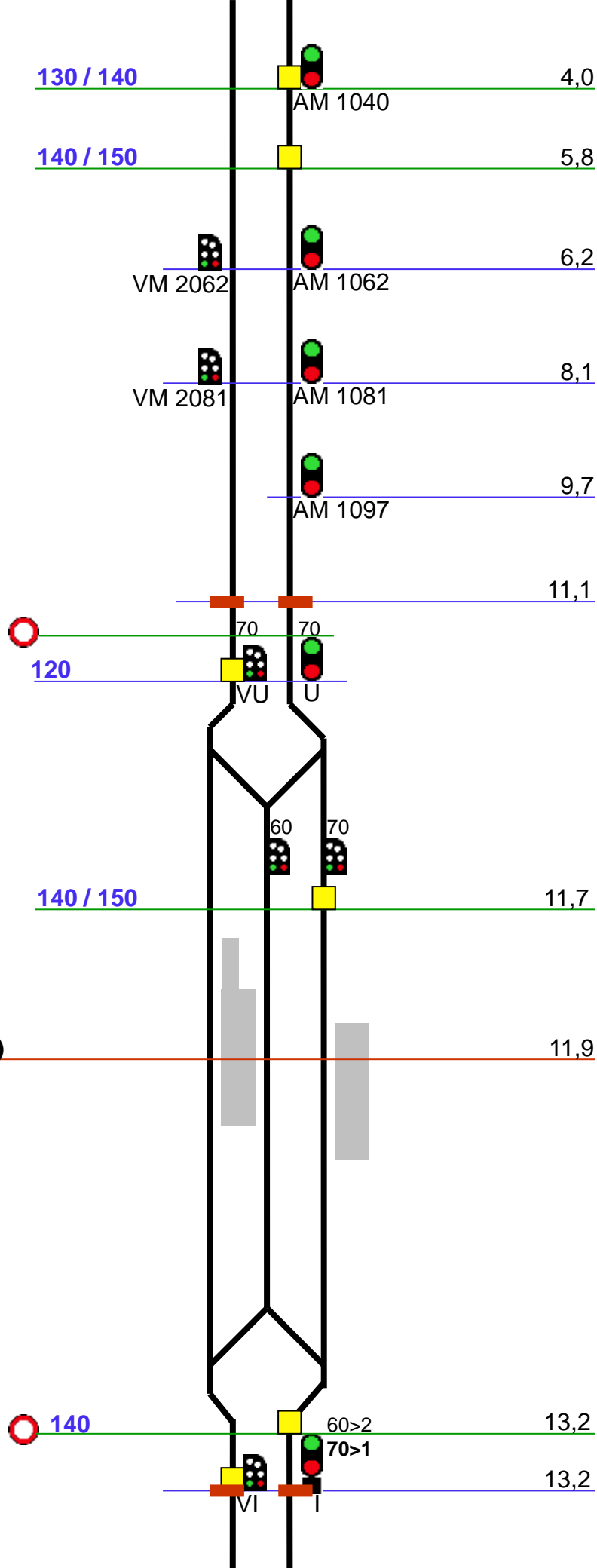

Brejning (Bet)

14,8

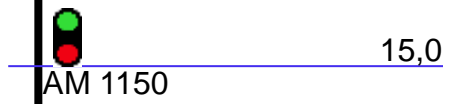
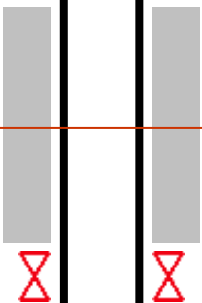

140 / 150 15,3

140 16,0

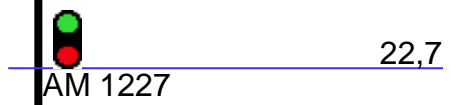
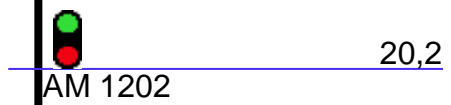
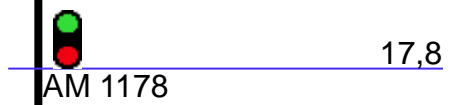

Linieblok
FC Fa

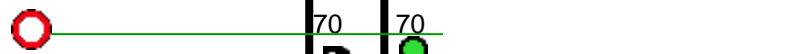

120 VU U

140 / 150 24,6

Industri

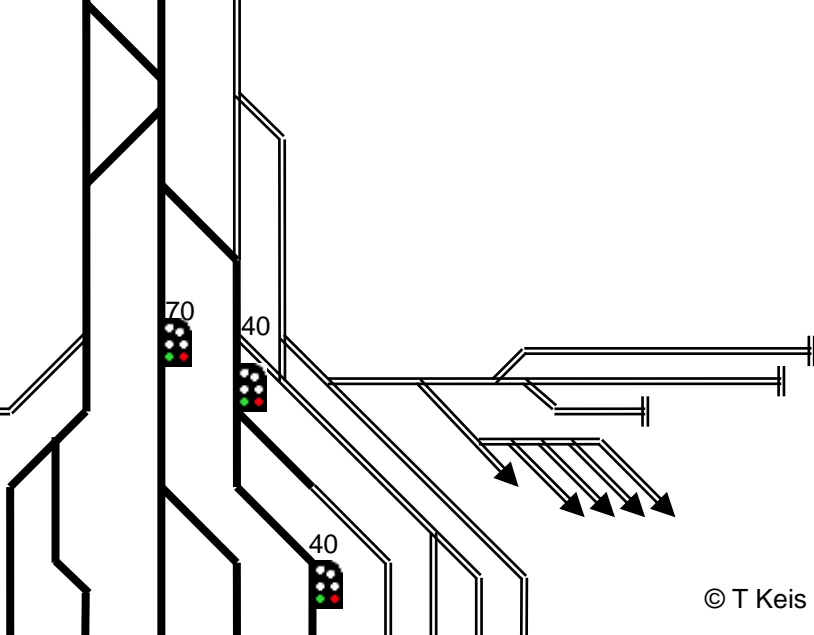

Veje (Vj)
Overgangsstation
FC Fa
ID 67700

25,7
114,2

6 5 4 3 2

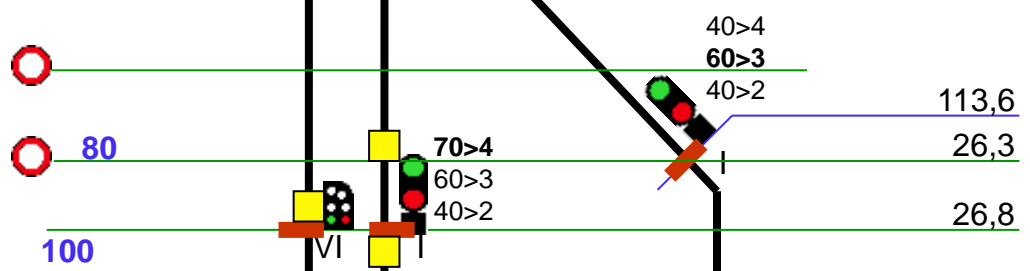

Veje Sygehus (Vjs)

28,2
113,2

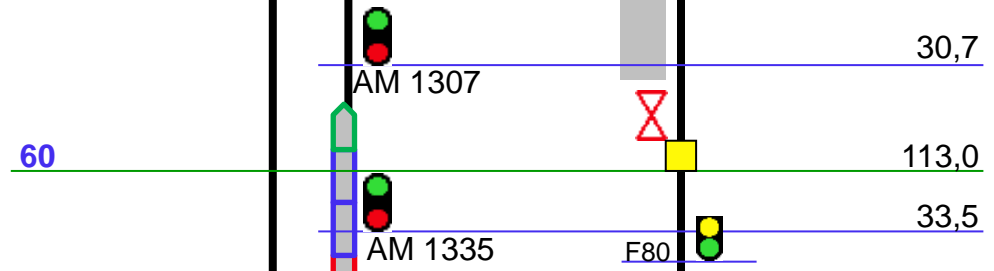

Linieblok
FC Sd

FC Sd

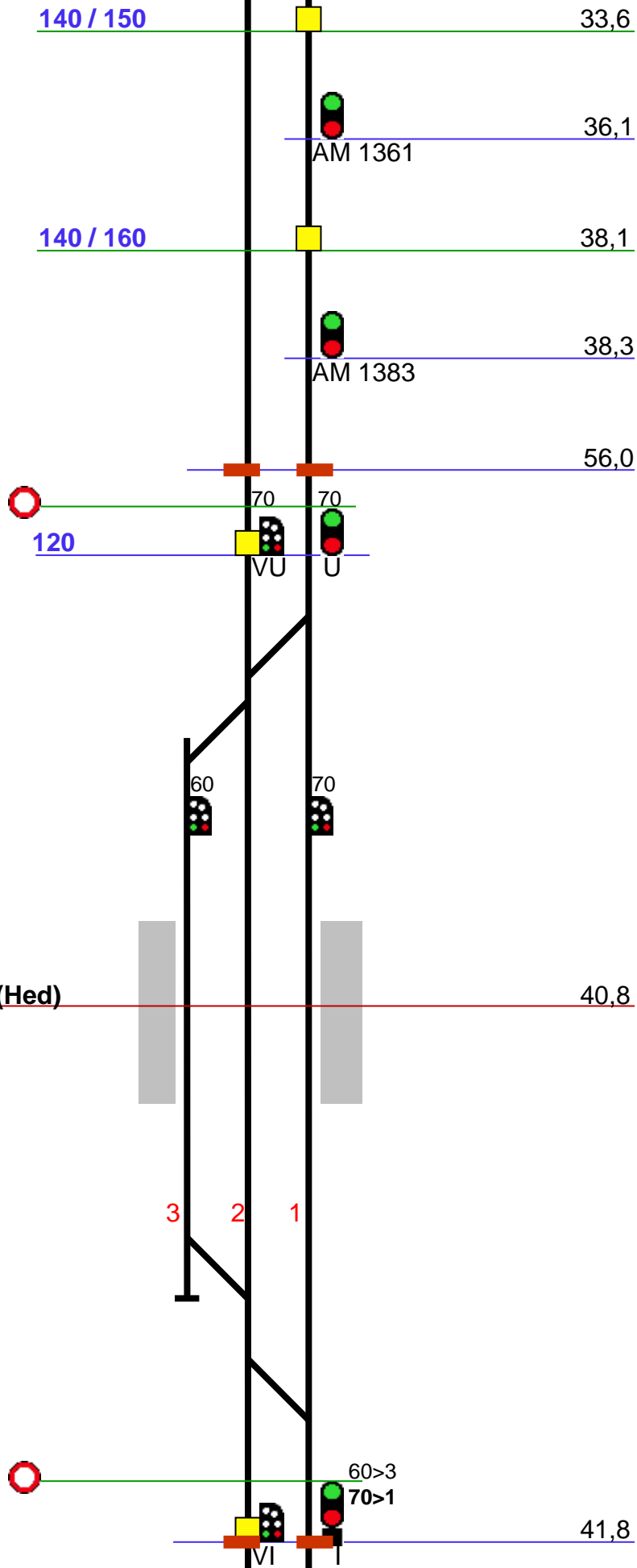

Linieblok
FC Sd

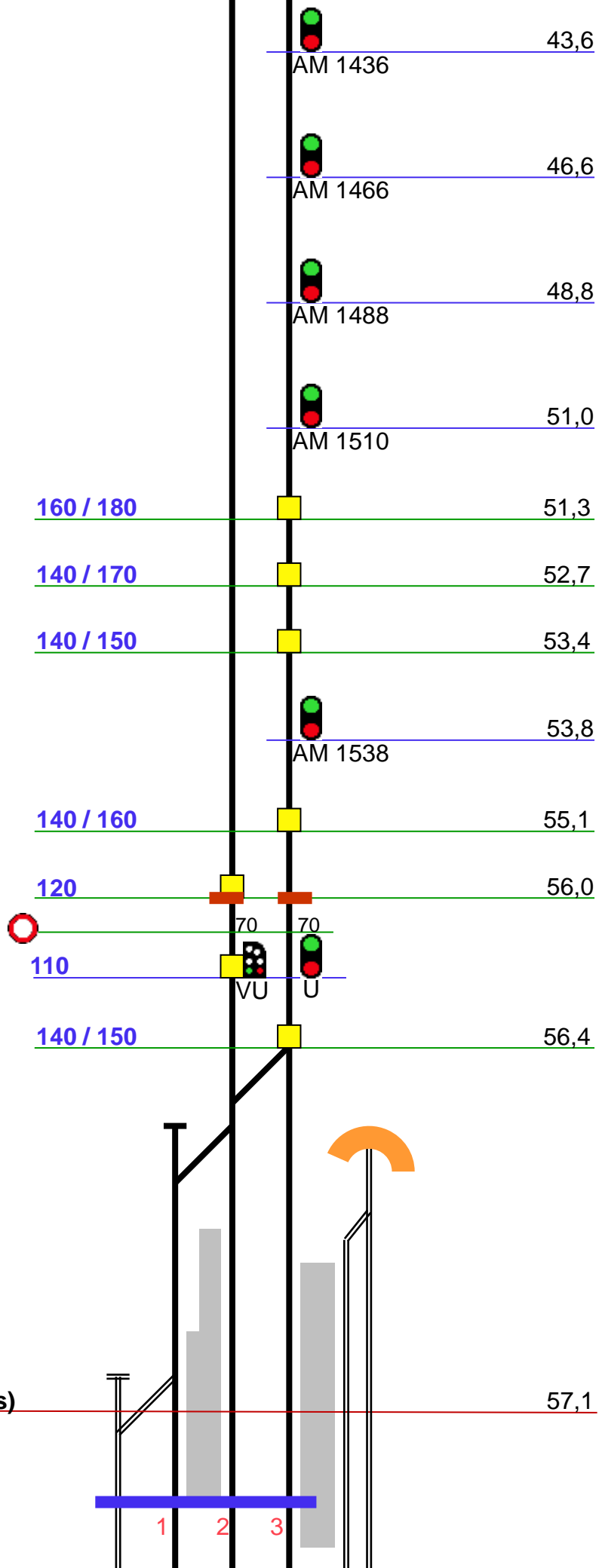

Horsens (Hs)

Overgangsstation
ID 65623

1 2 3

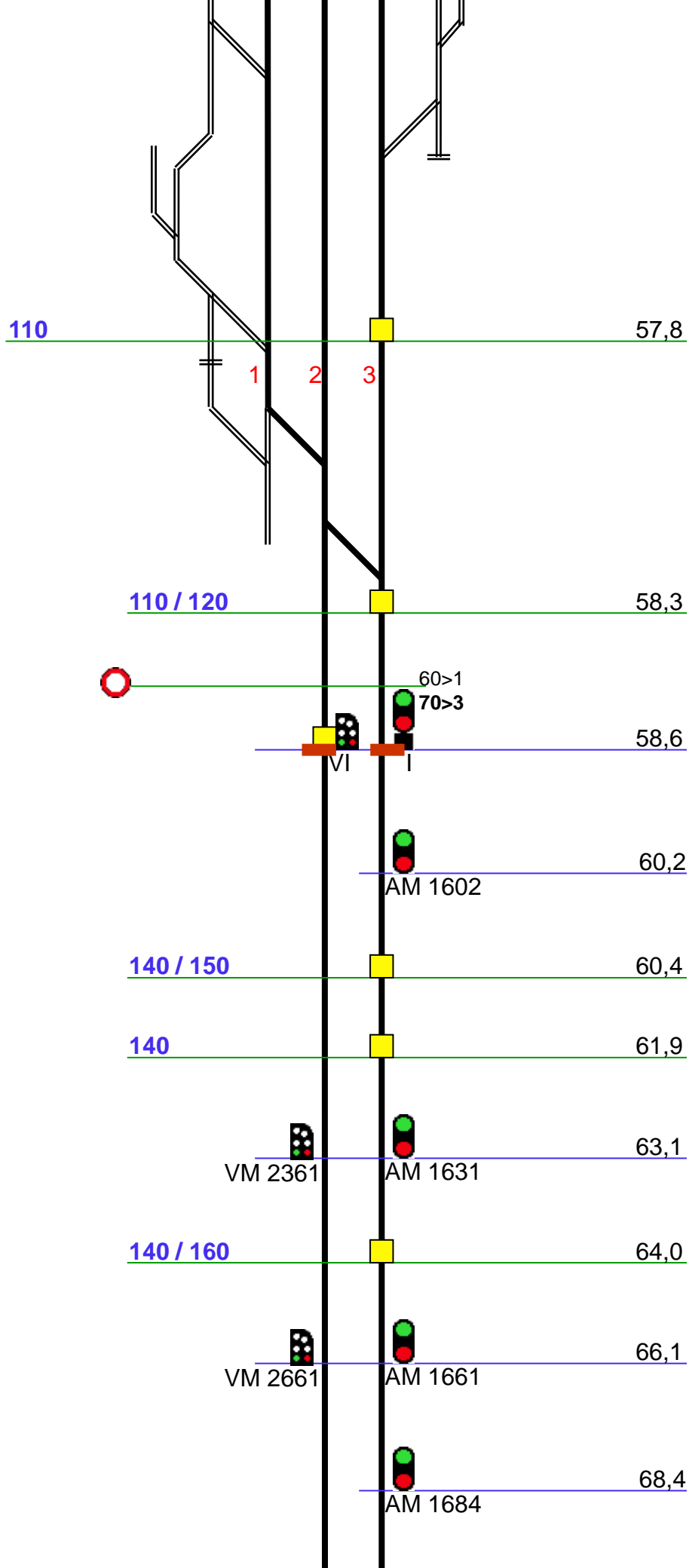

Linieblok
FC Sd

FC Sd

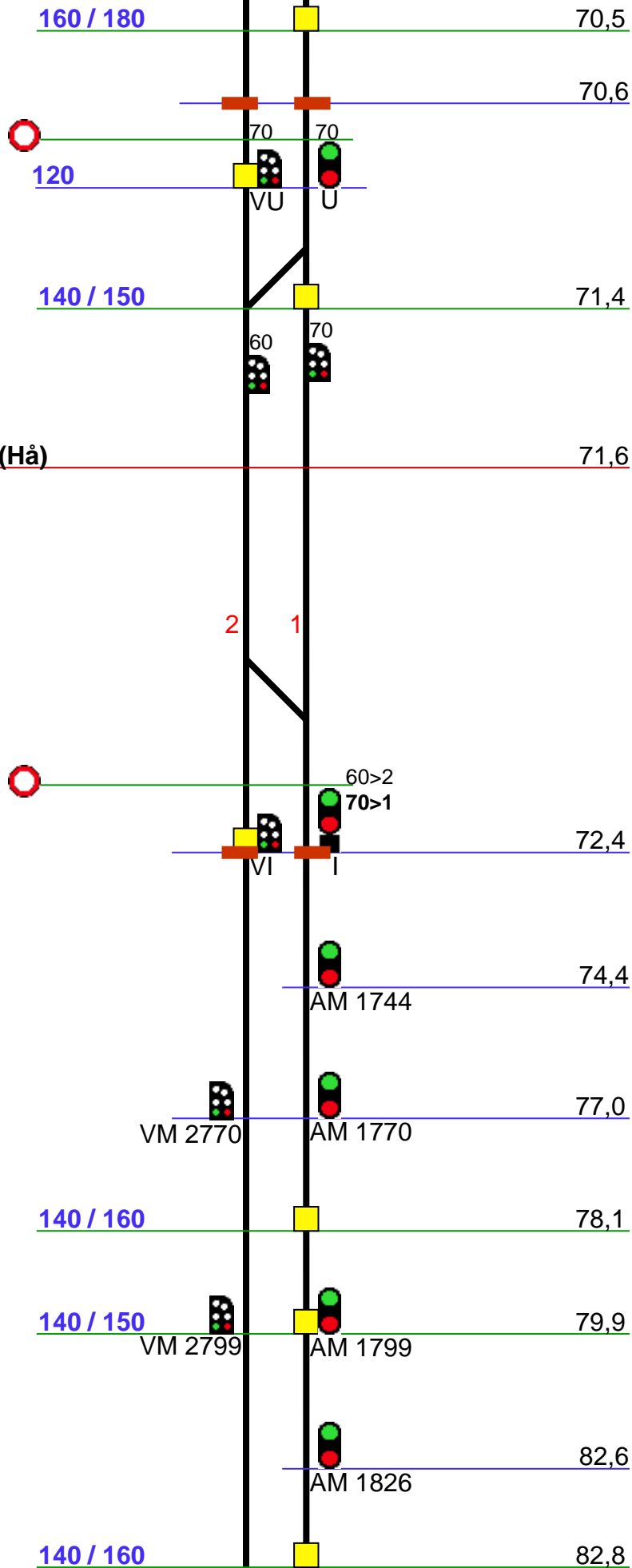

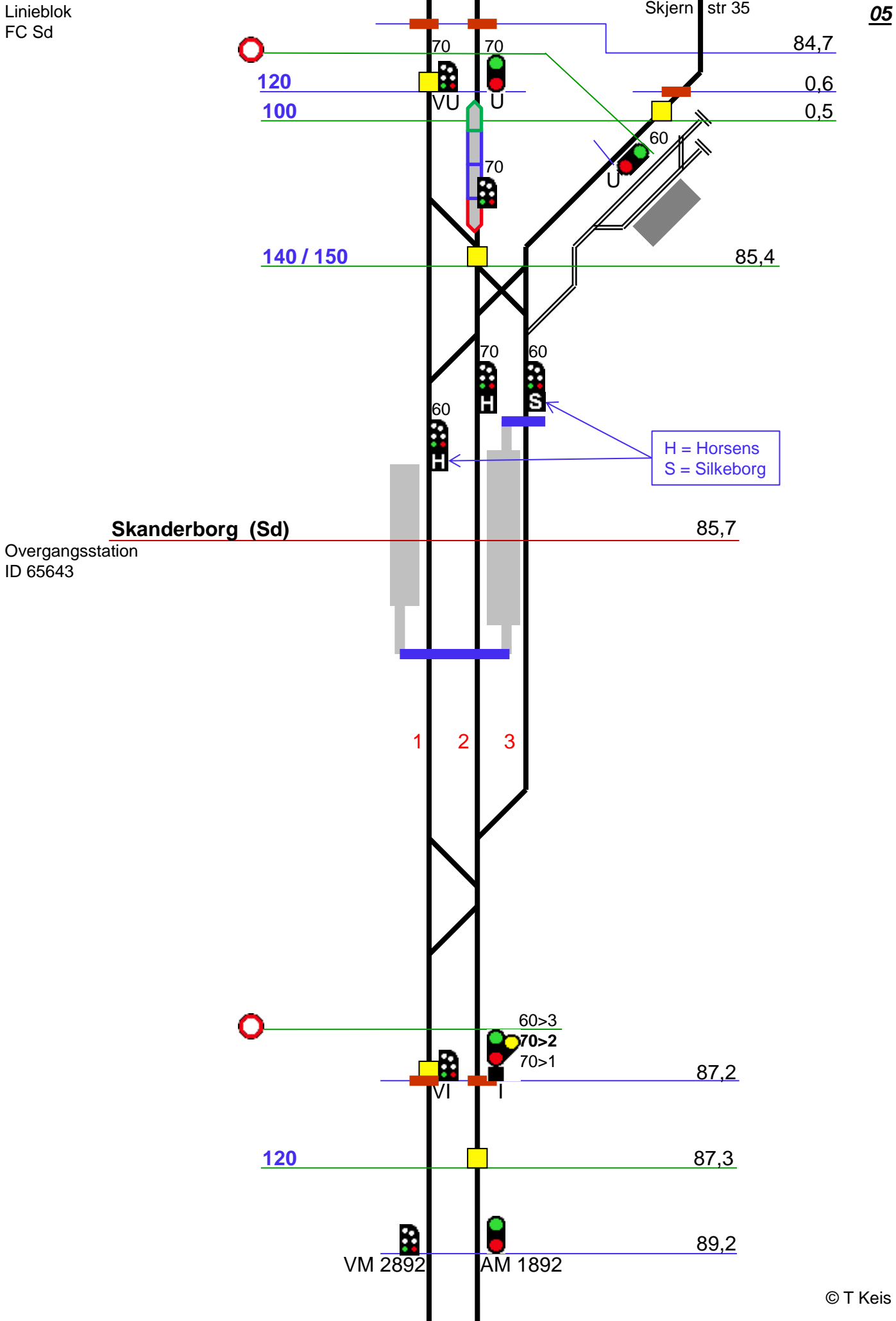

Linieblok
FC Sd

FC Sd

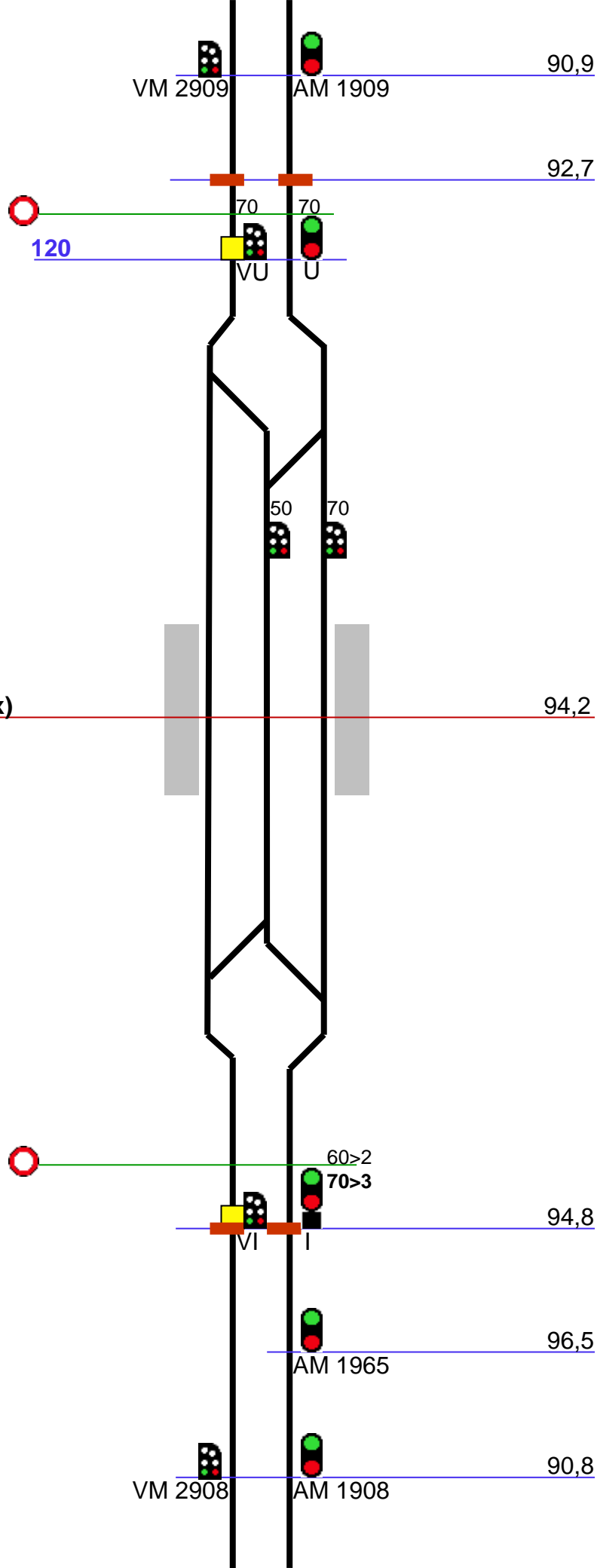

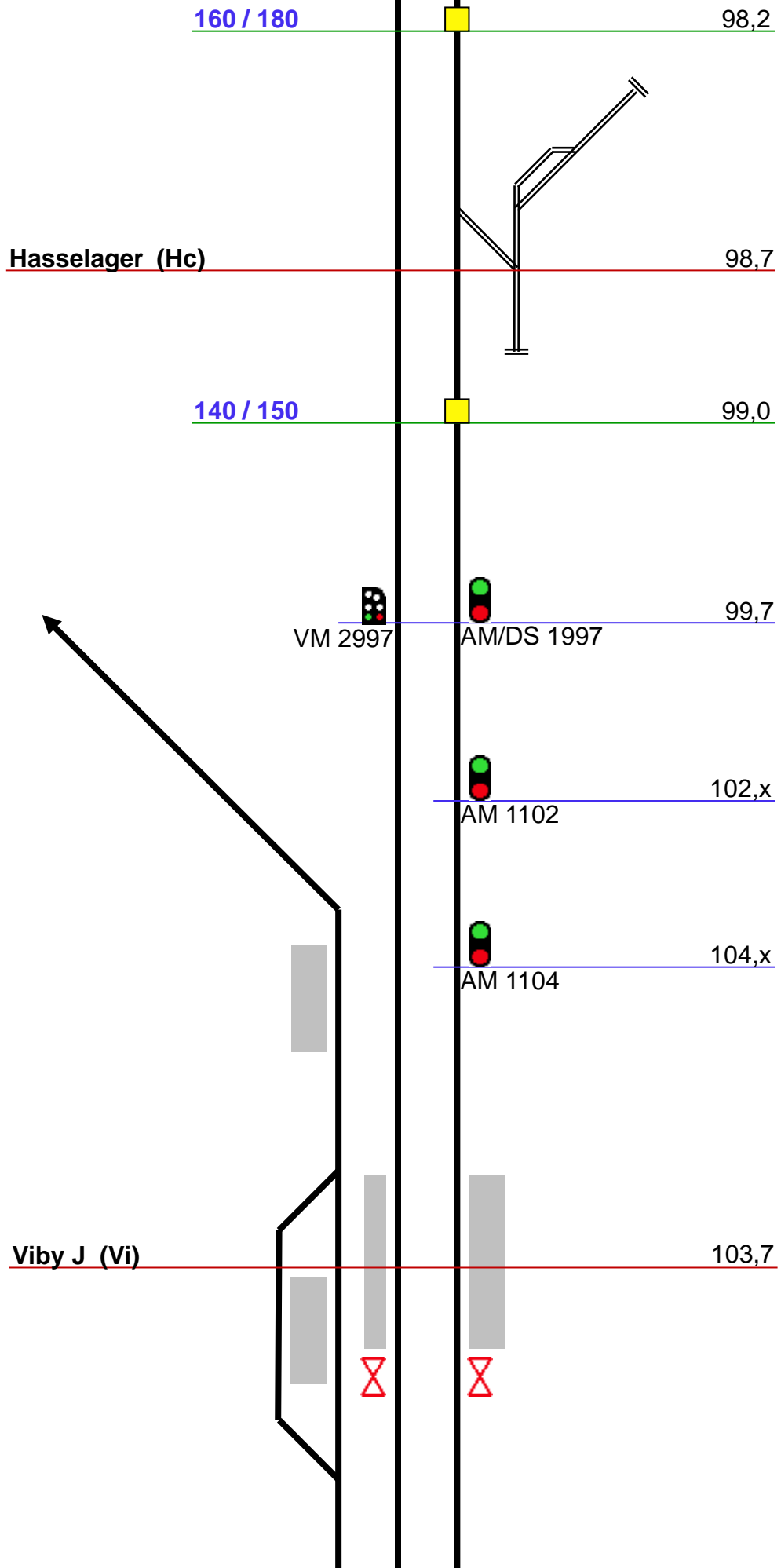

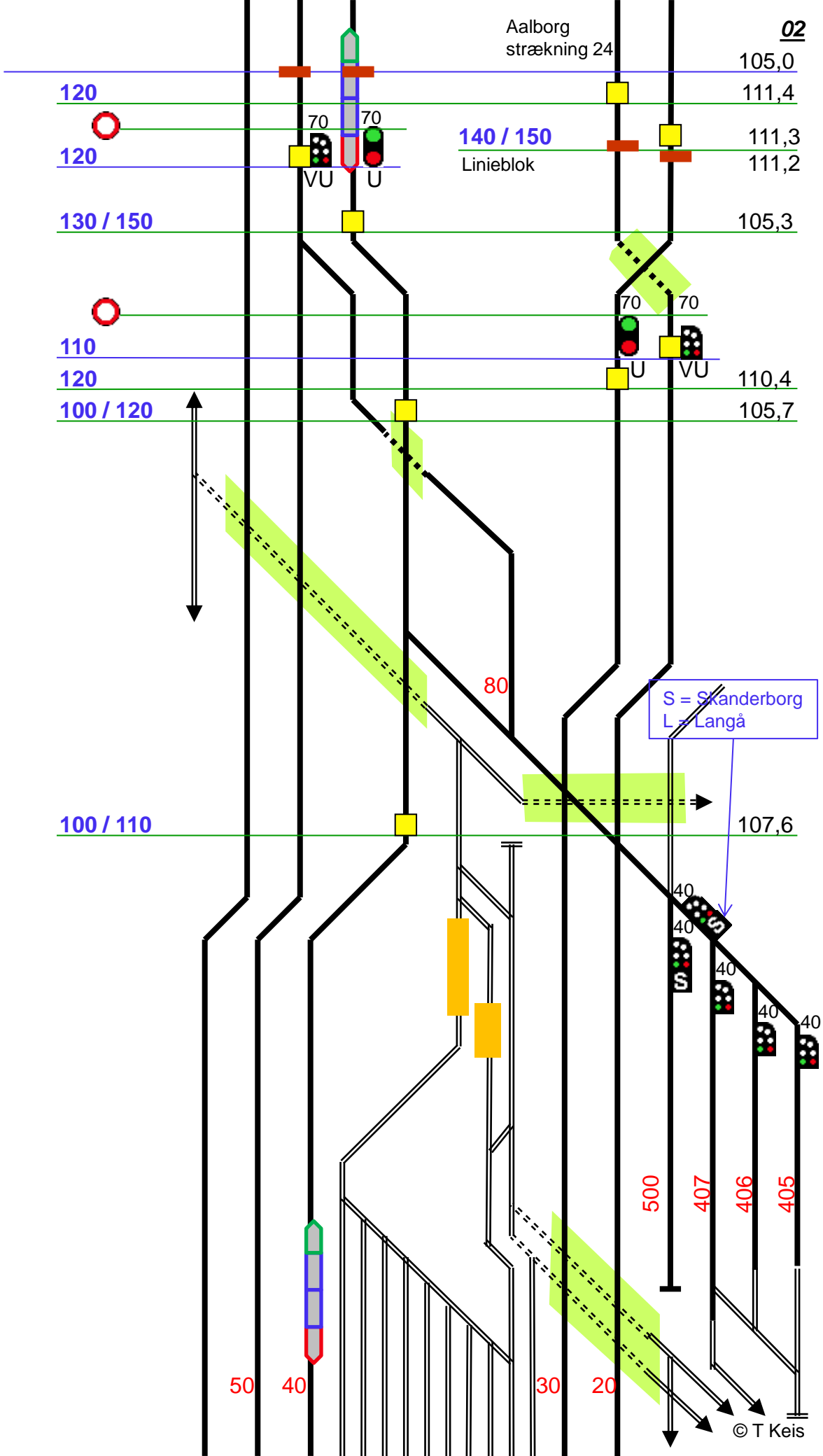

S = Skanderborg
L = Långå

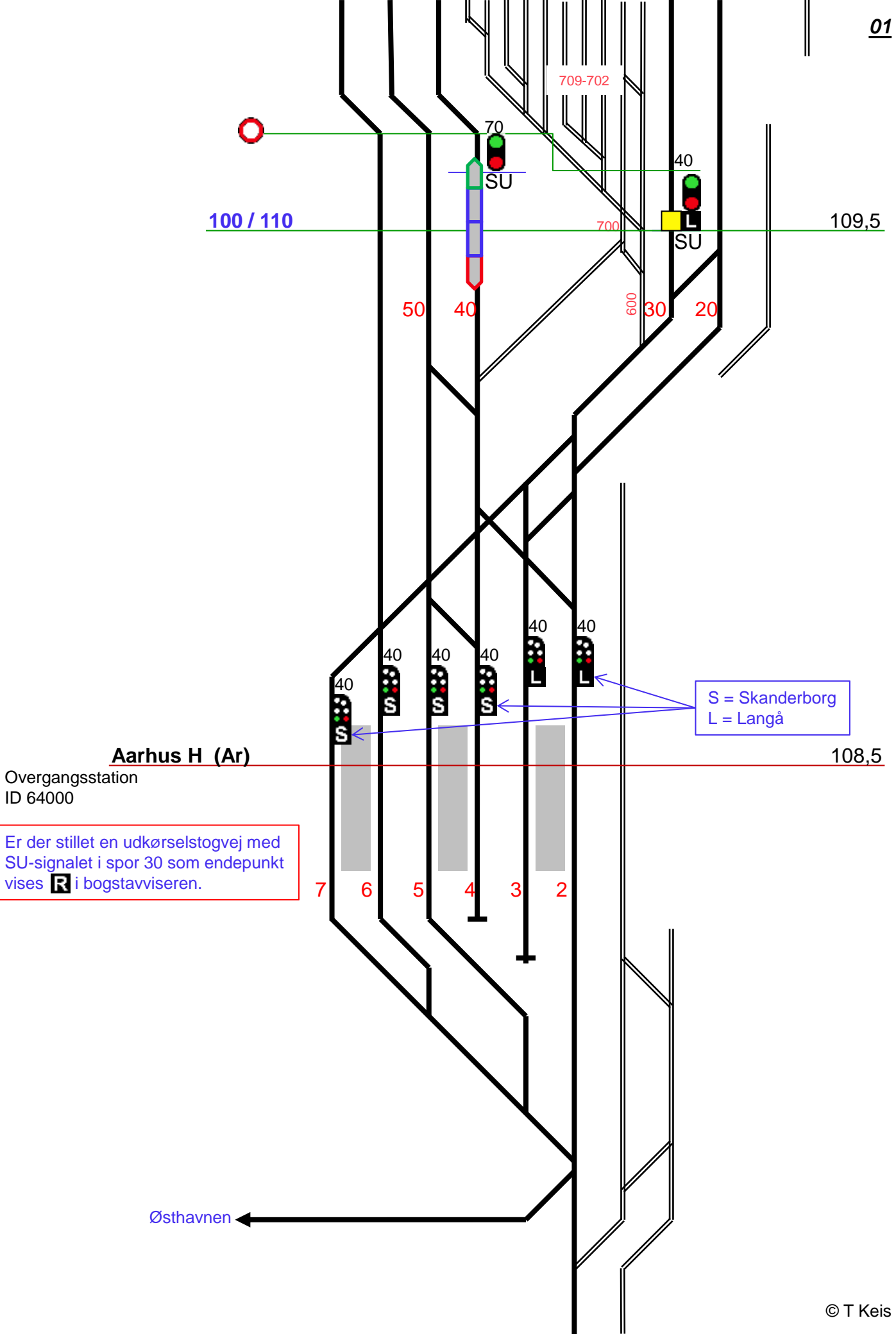

S = Skanderborg
L = Langå

Er der stillet en udkørselstogvej med SU-signalet i spor 30 som endepunkt vises **R** i bogstavviseren.