

**Esbjerg (Es)**  
Overgangsstation  
ID 65000

55,7

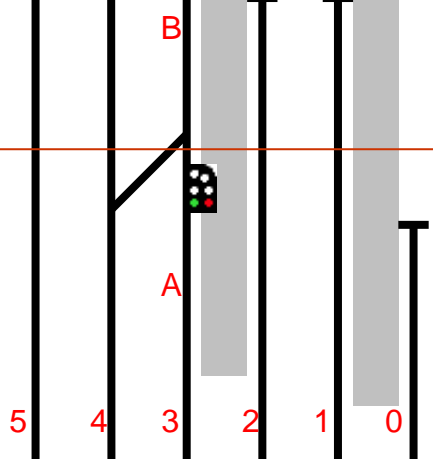

- 40>5
- 40>4
- 40>3
- 40>2
- 40>1**
- 40>0

56,3

- 40>5
- 40>4
- 40>3
- 40>2**
- 40>1
- 40>0

54,8



40

Forsyningen

F80

**Spangsbjerg (Esn)**

58,2

110

54,0

**Gjesing (Gje)**

60,1

Lykkegård

52,116 – 52,535

48,4

Linieblok / Vekselspor  
FC Es

Struer  
strækning 31

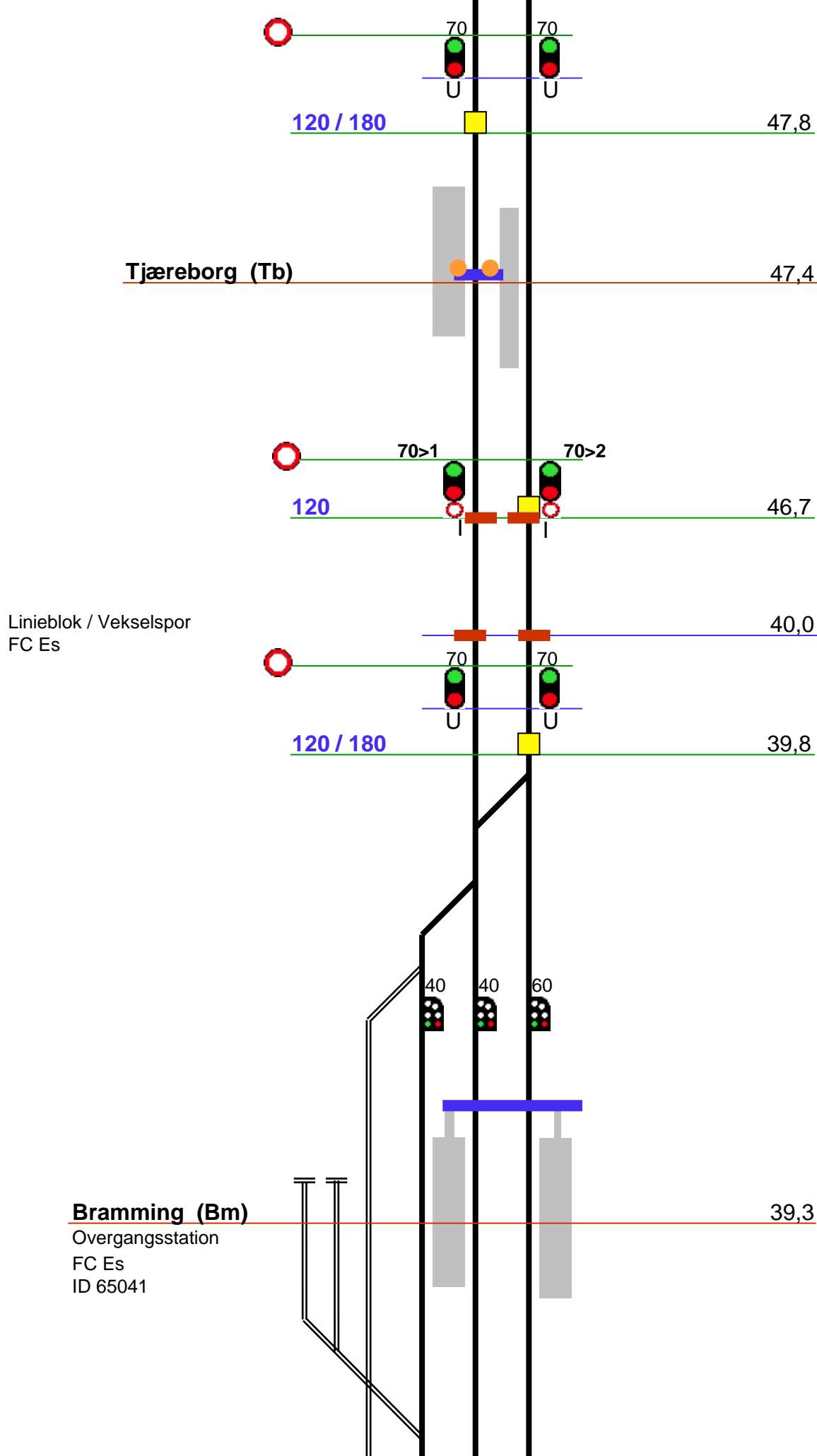

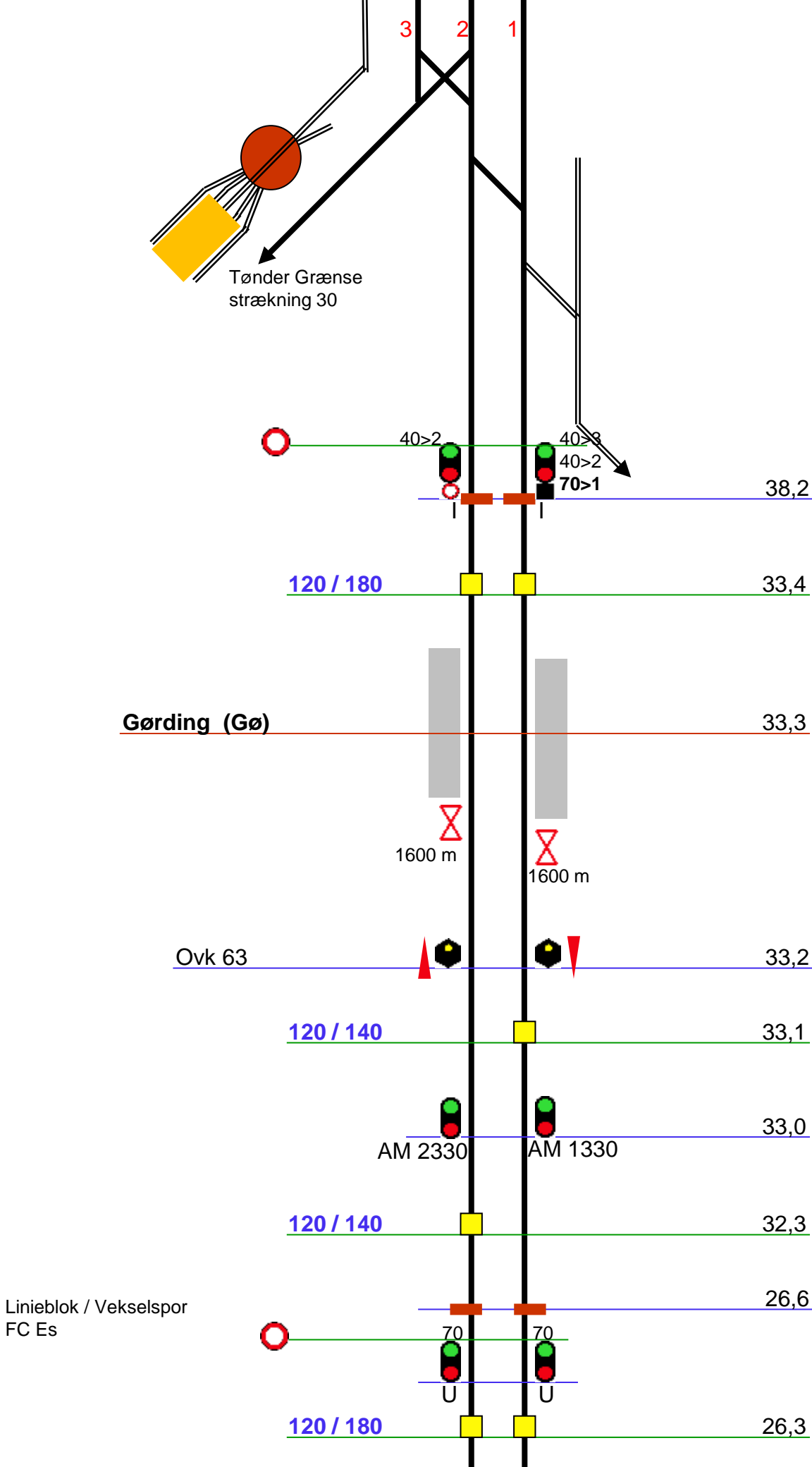

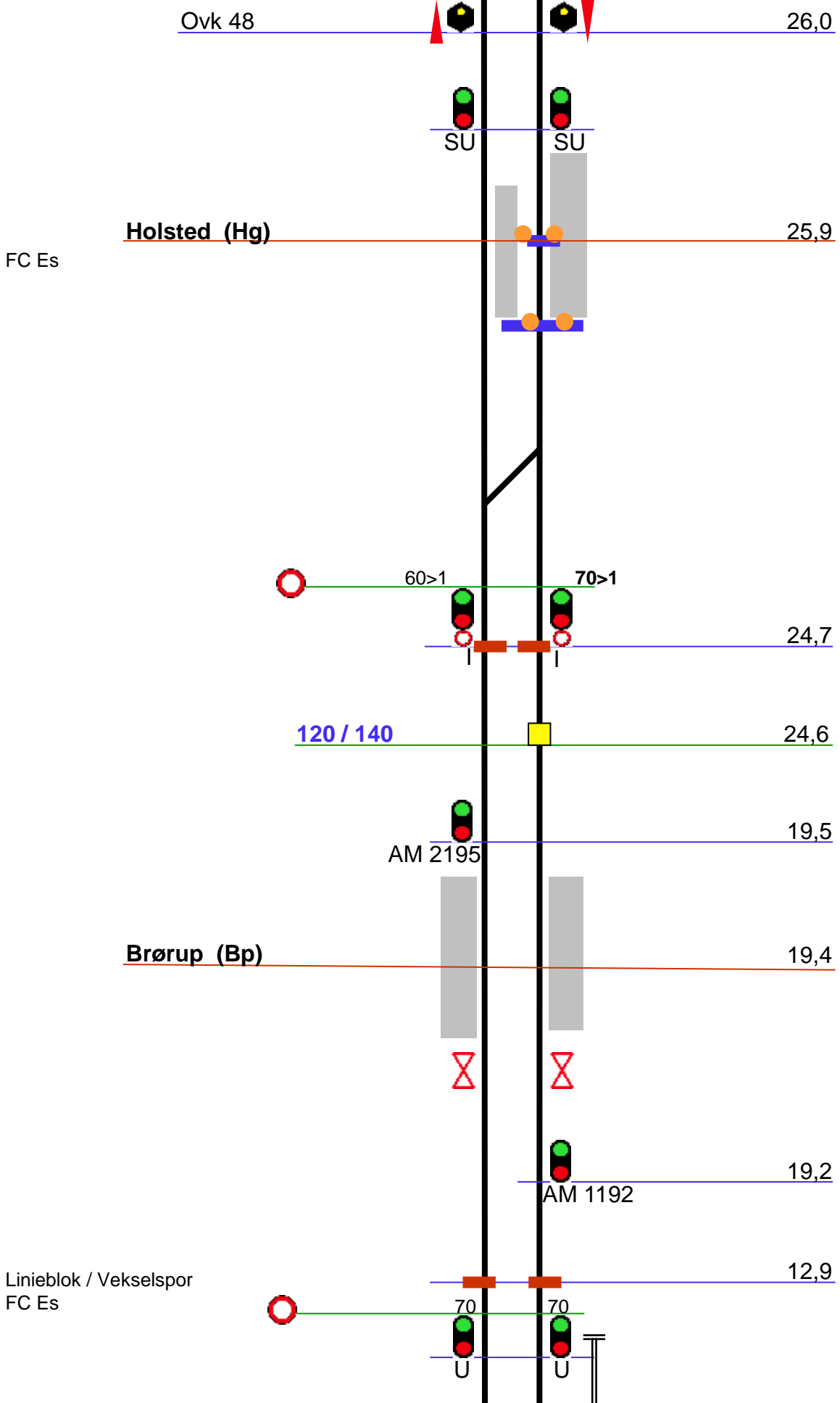

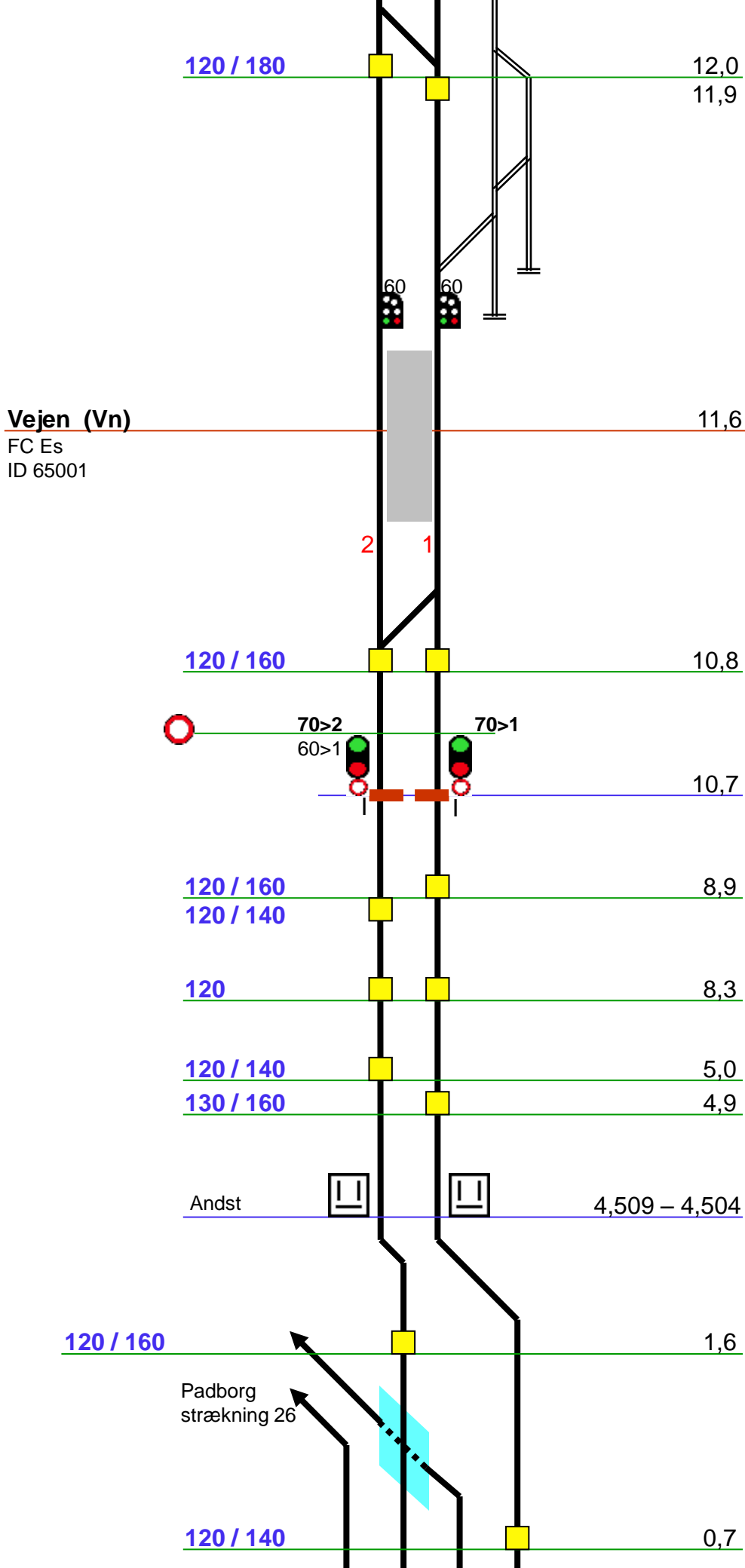

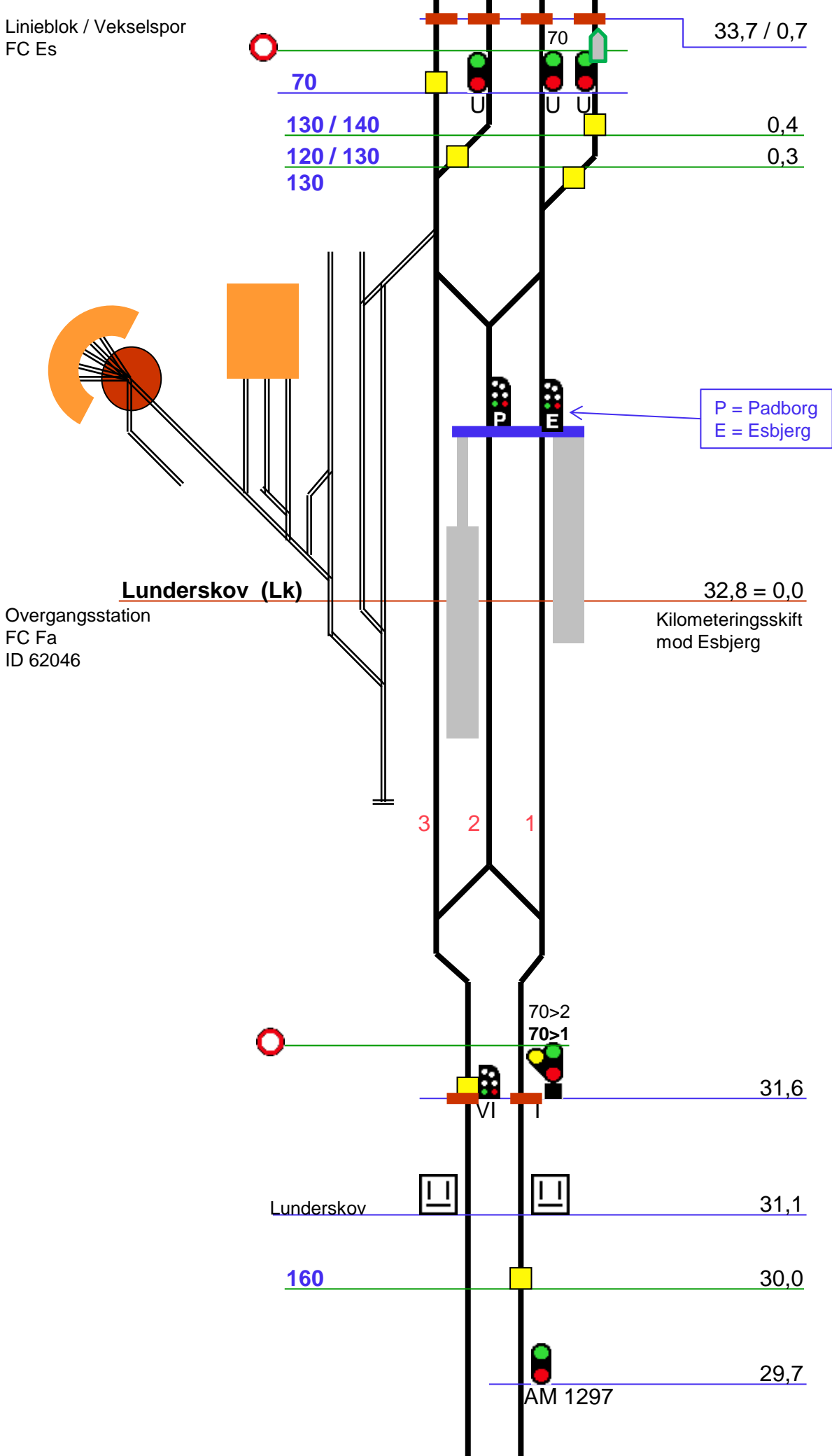

Linieblok  
FC Fa

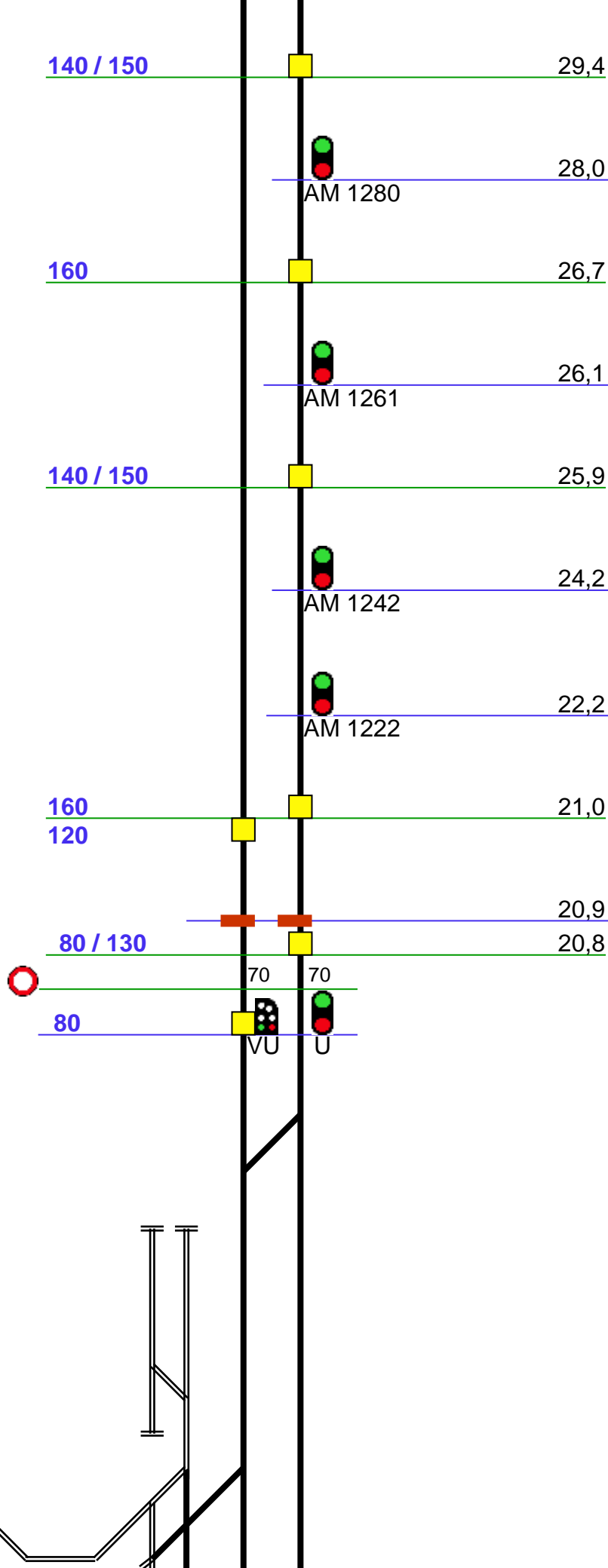

Industri





Linieblok  
FC Fa

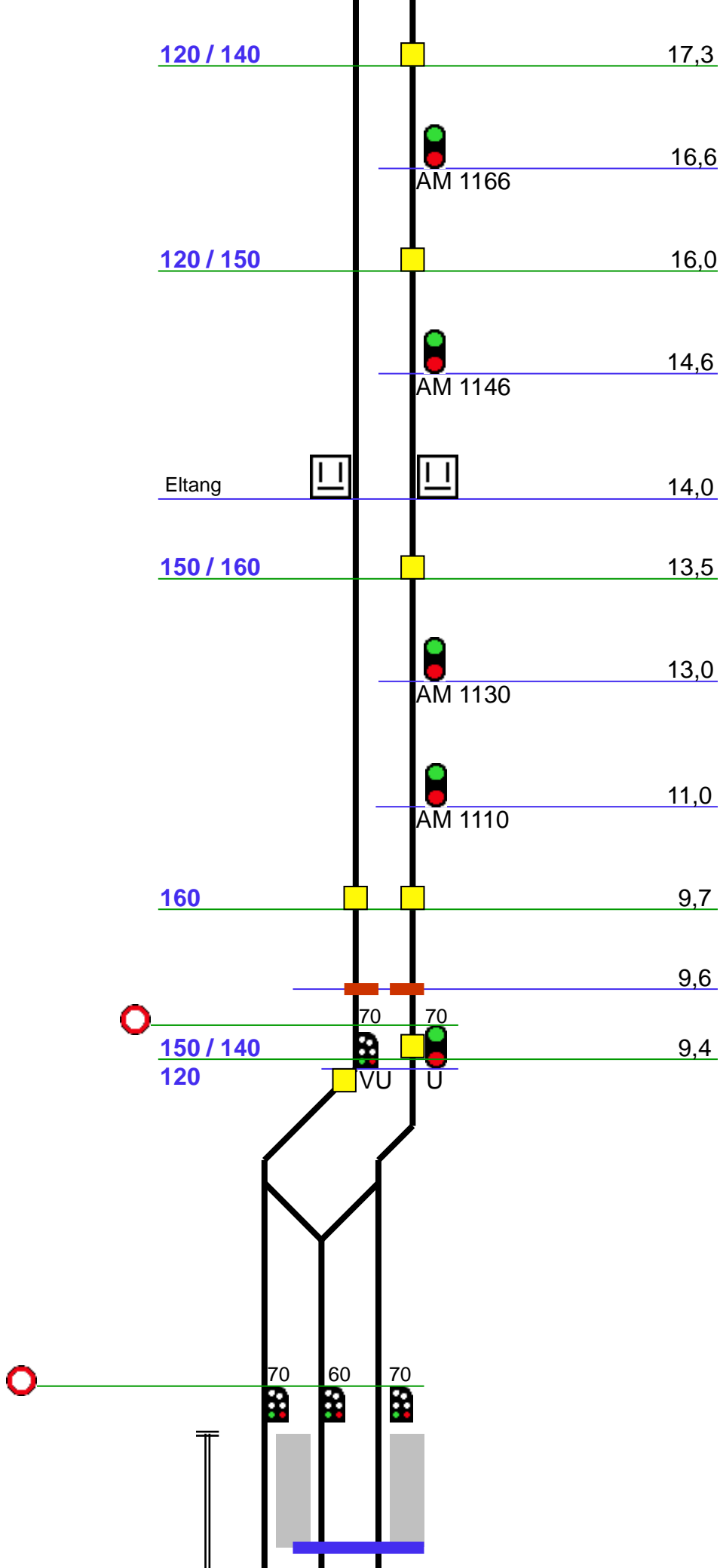

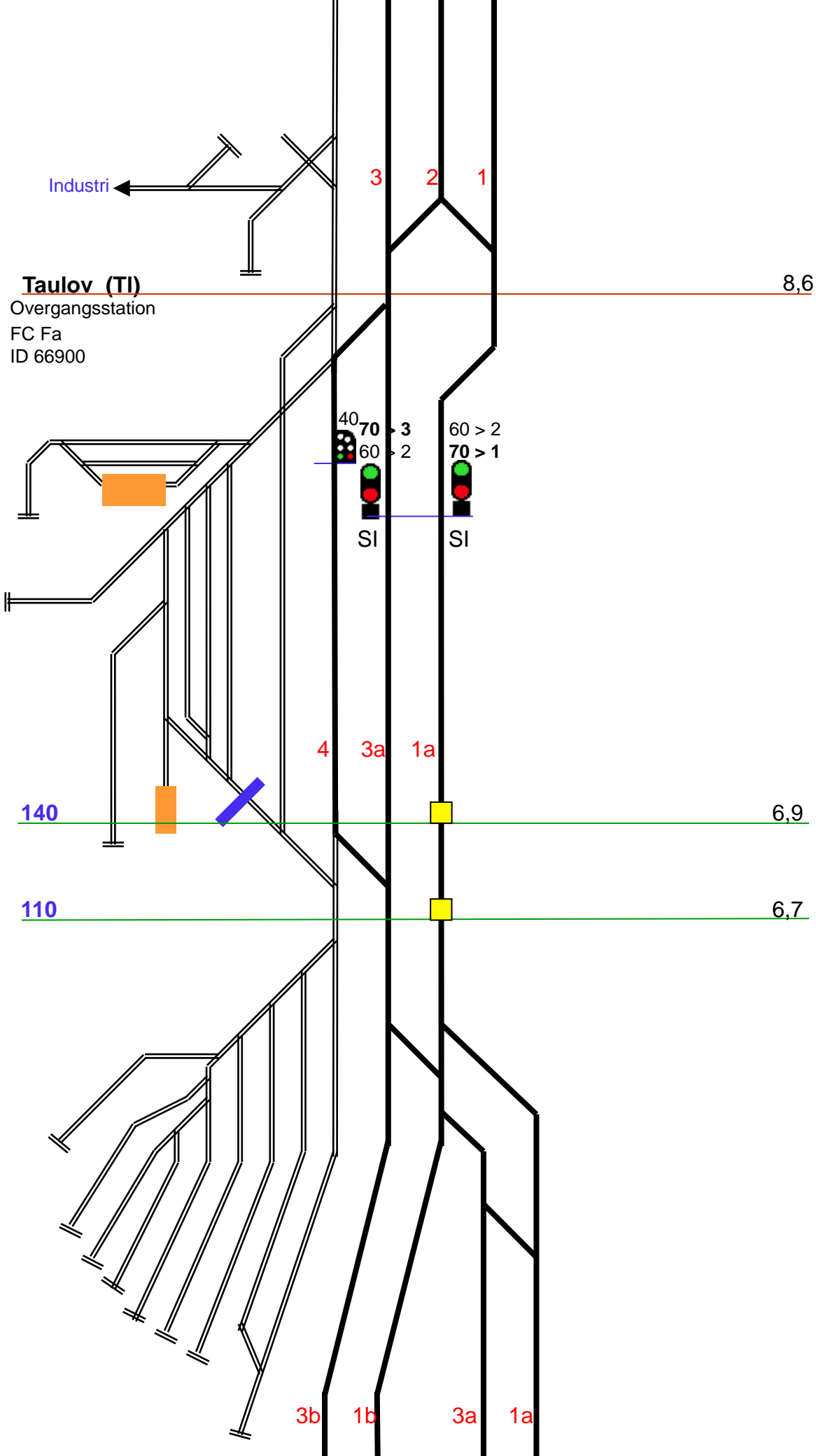

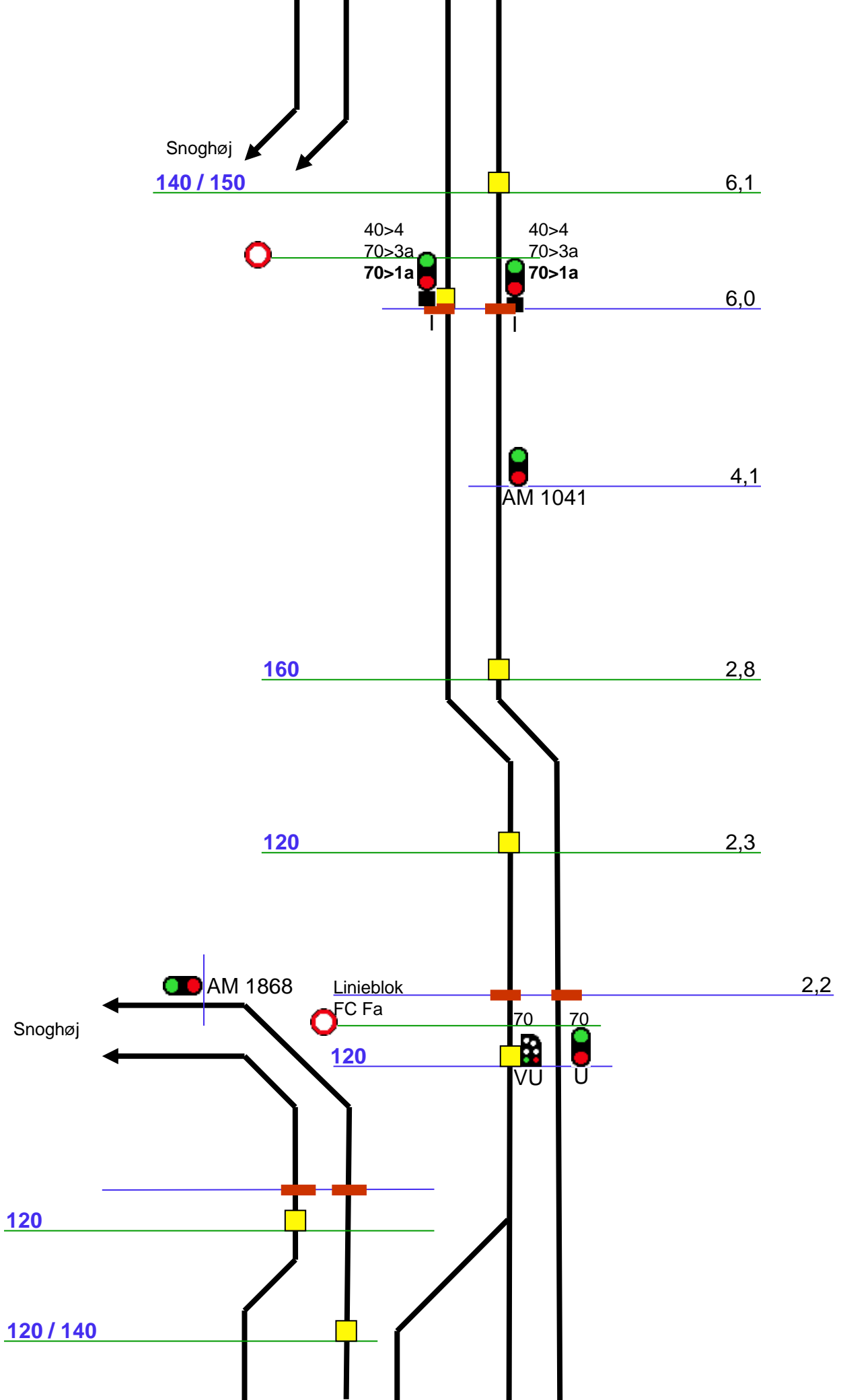

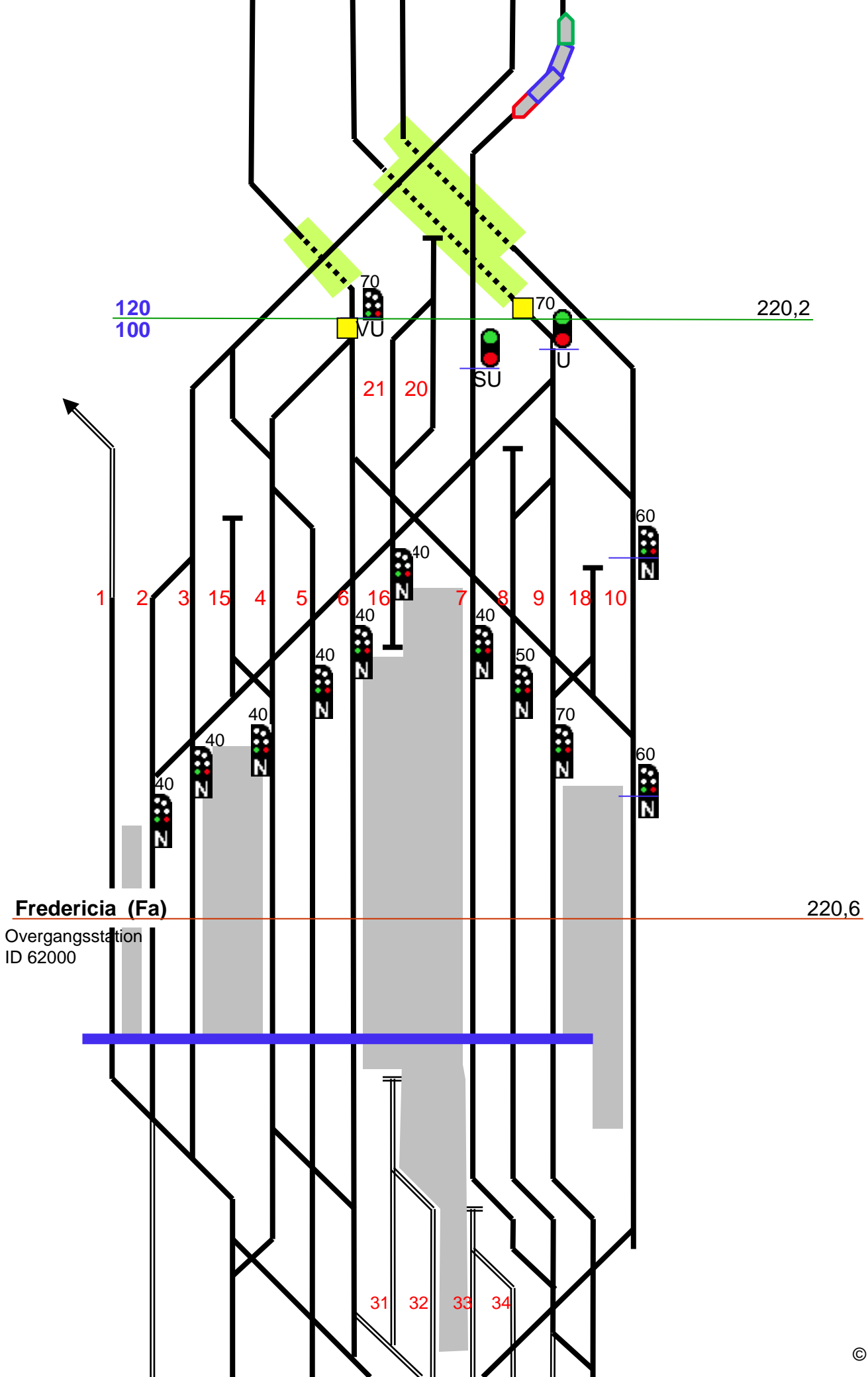



Linieblok  
FC Fa

FC Fa

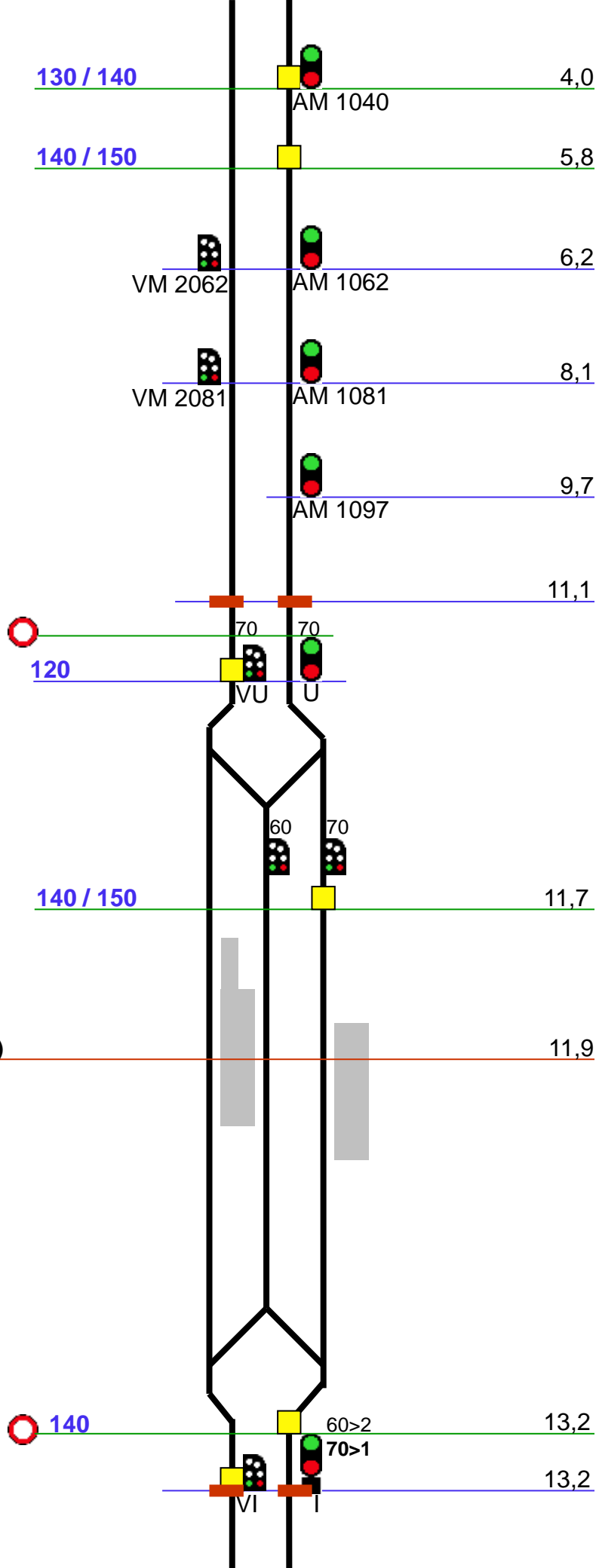

Brejning (Bet)

14,8

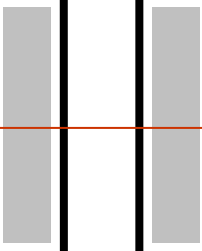

AM 1150

15,0

140 / 150



15,3

140



16,0



AM 1178

17,8



AM 1202

20,2



AM 1227

22,7

Linieblok  
FC Fa



24,5



70

70

120



VU



U

24,6

140 / 150

Industri

70

40

40



**Veje (Vj)**  
Overgangsstation  
FC Fa  
ID 67700

25,7  
114,2

6 5 4 3 2

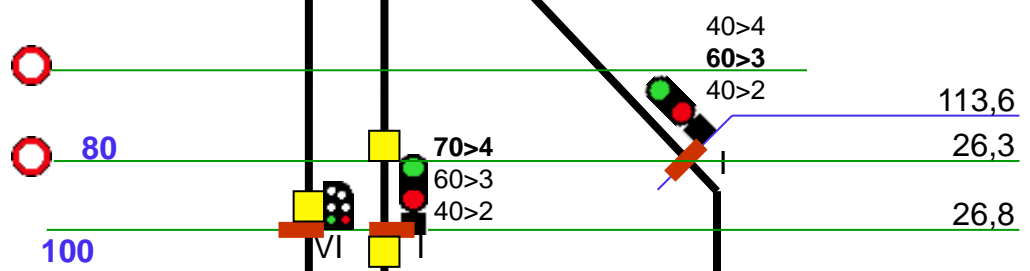

**Veje Sygehus (Vjs)**

28,2  
113,2

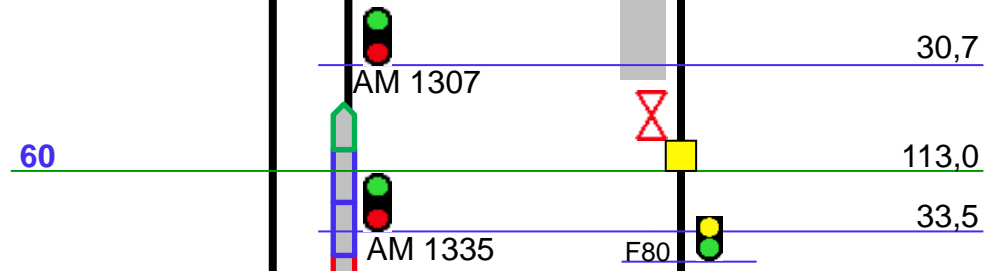

Linieblok  
FC Sd

FC Sd

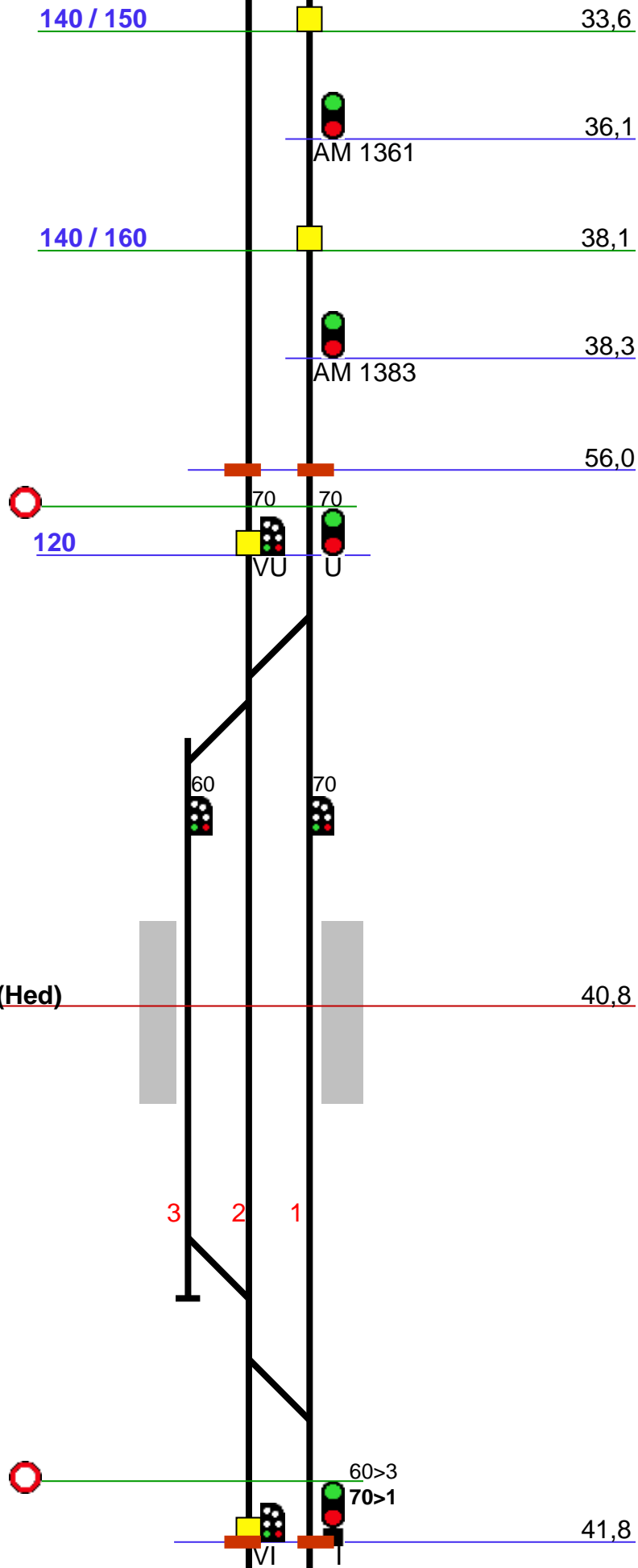

Linieblok  
FC Sd

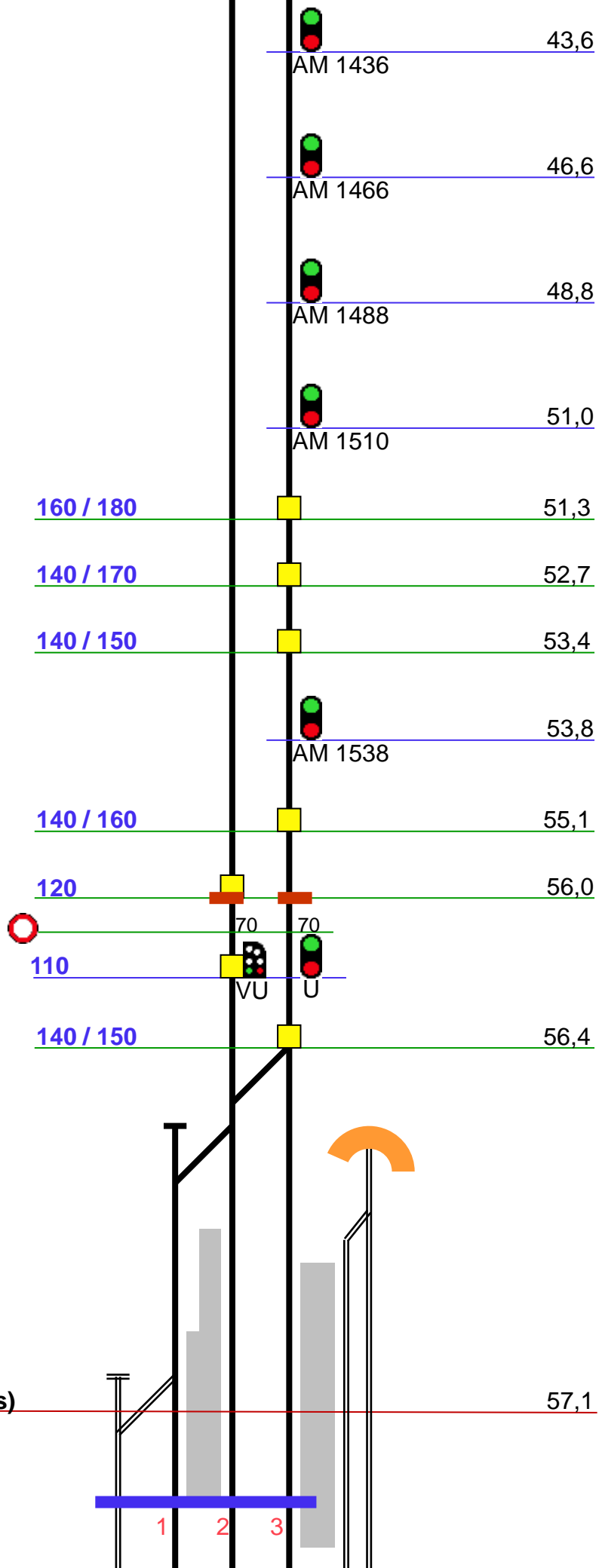

Horsens (Hs)

Overgangsstation  
ID 65623

1 2 3

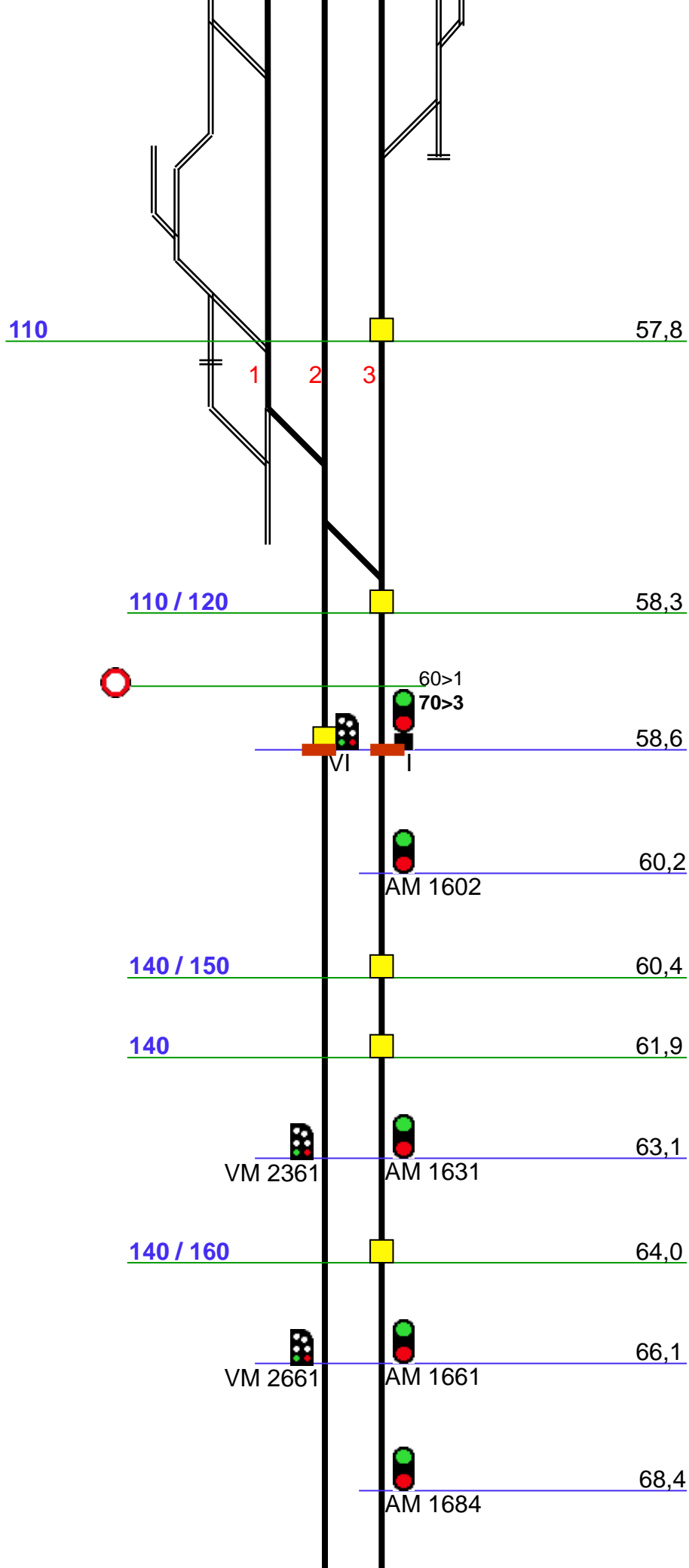

Linieblok  
FC Sd

FC Sd

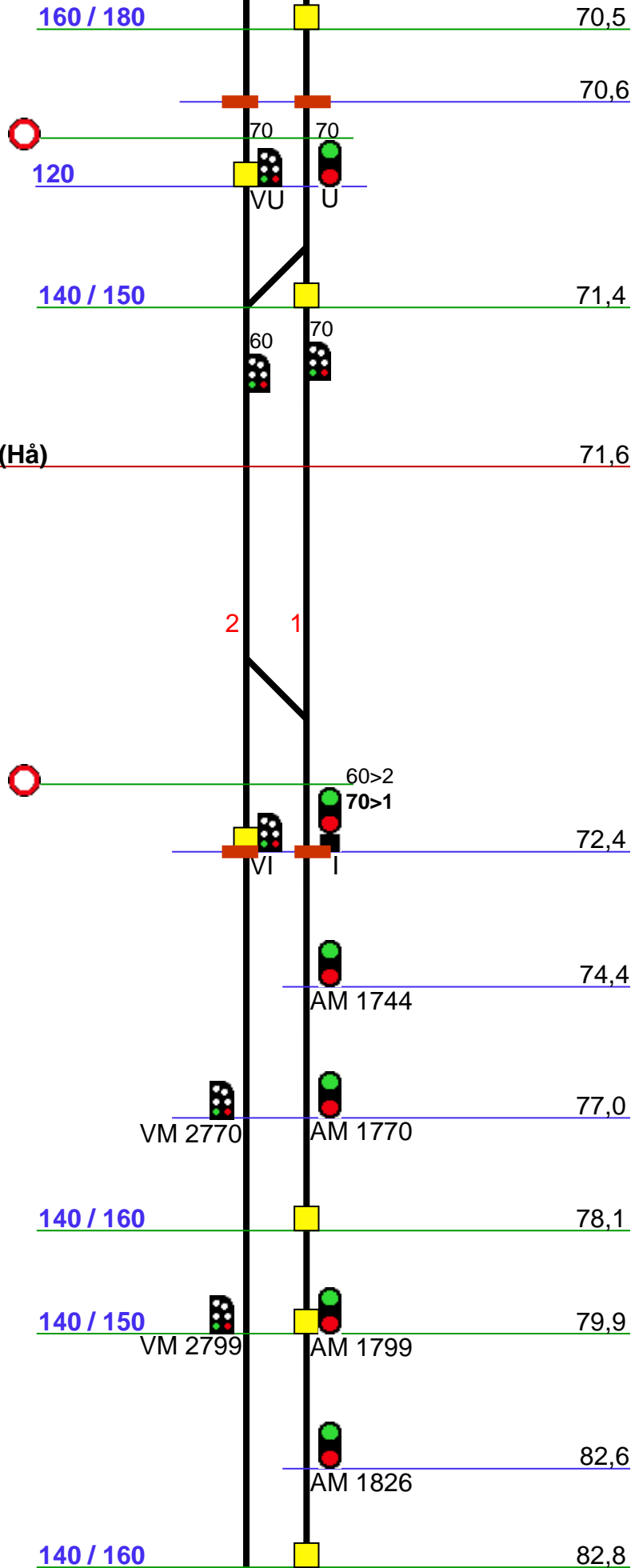

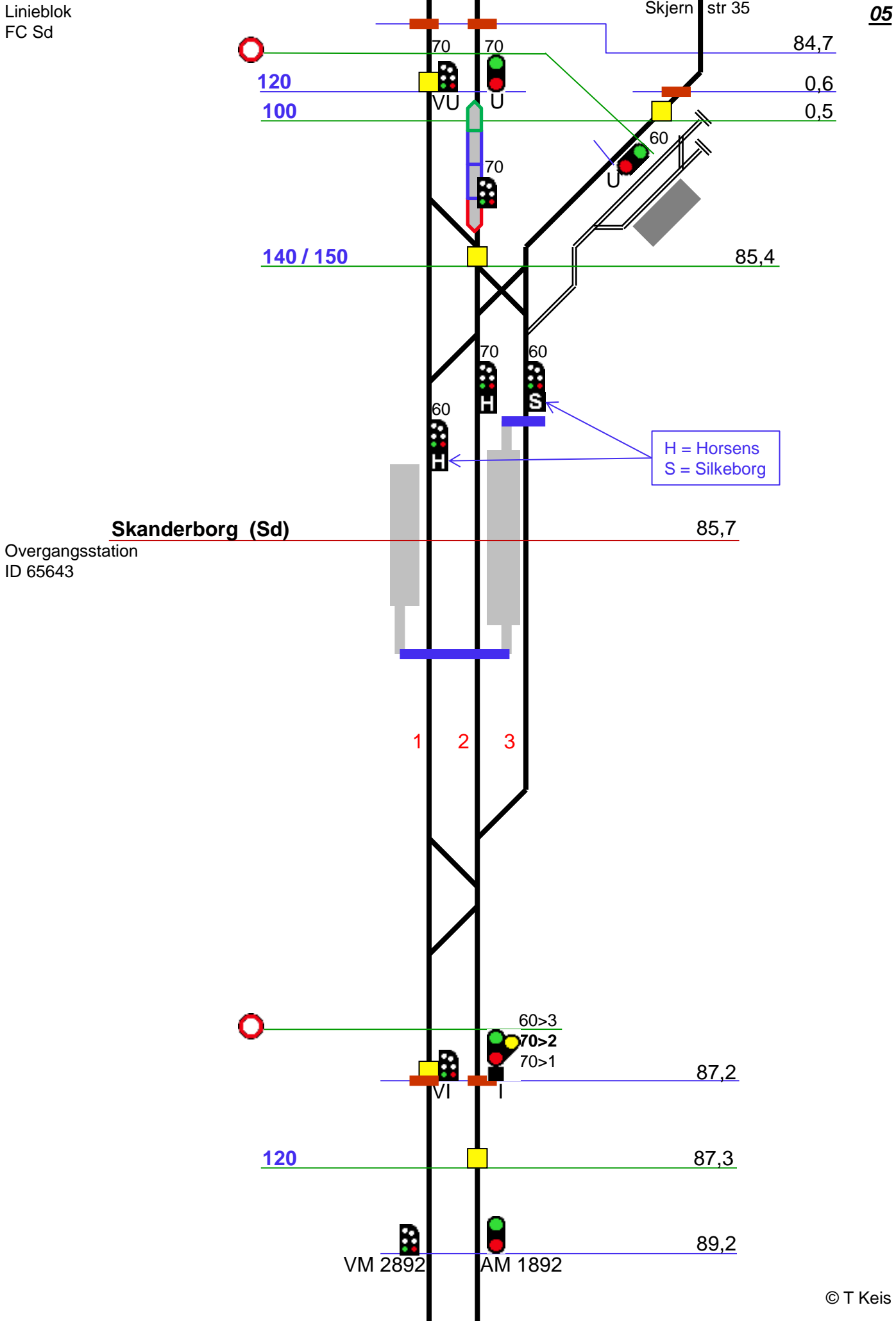

Linieblok  
FC Sd

FC Sd

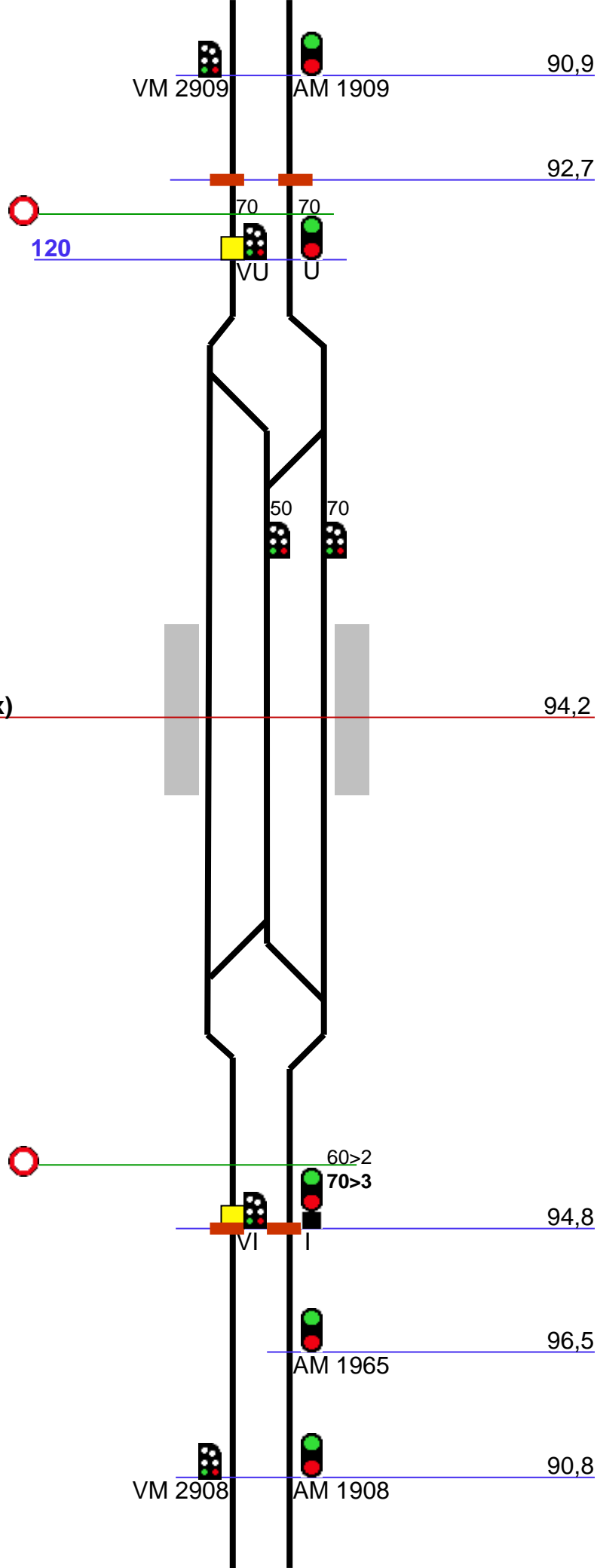

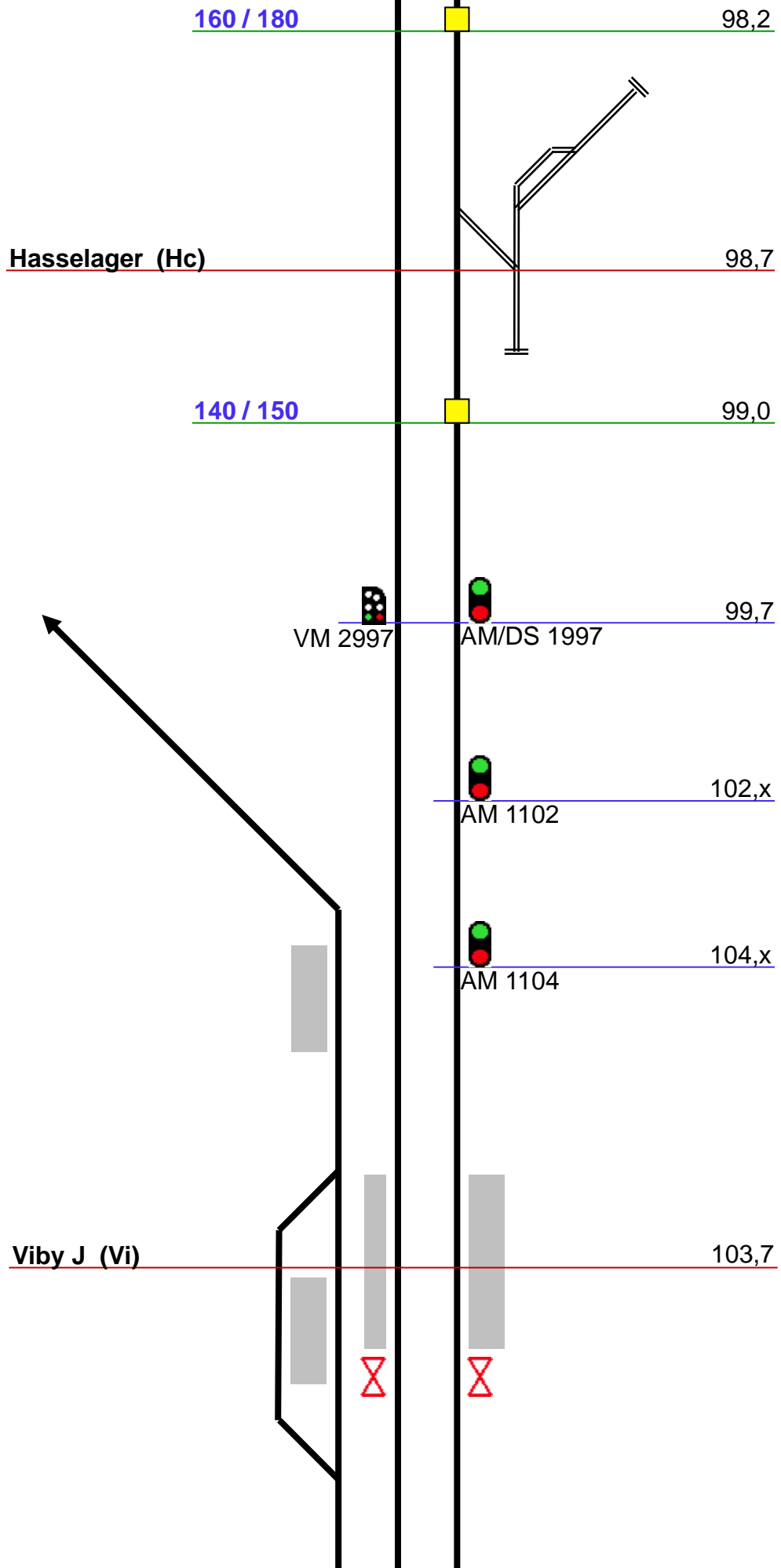



Linieblok  
FC Sd

Aalborg  
strækning 24

02

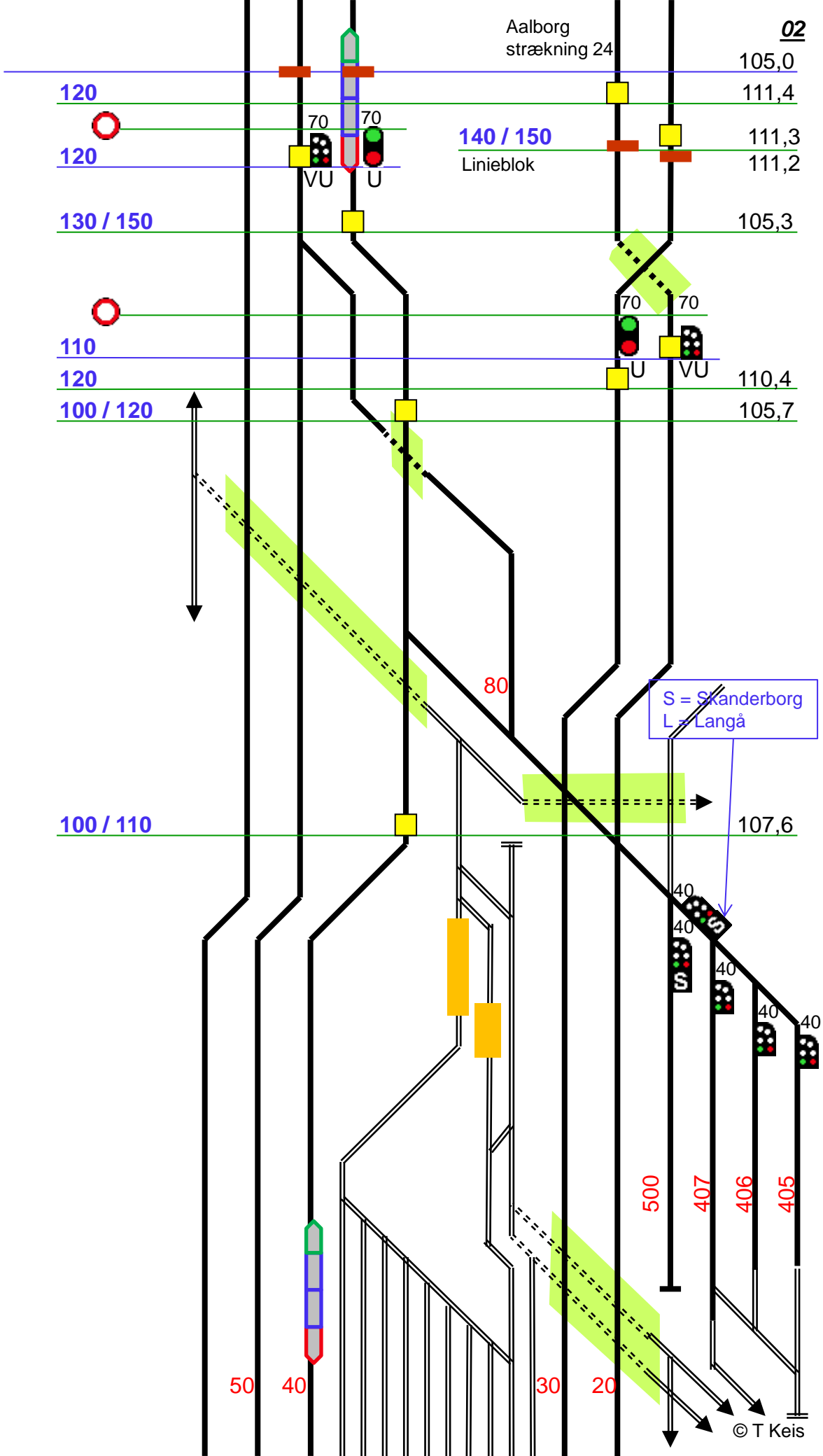

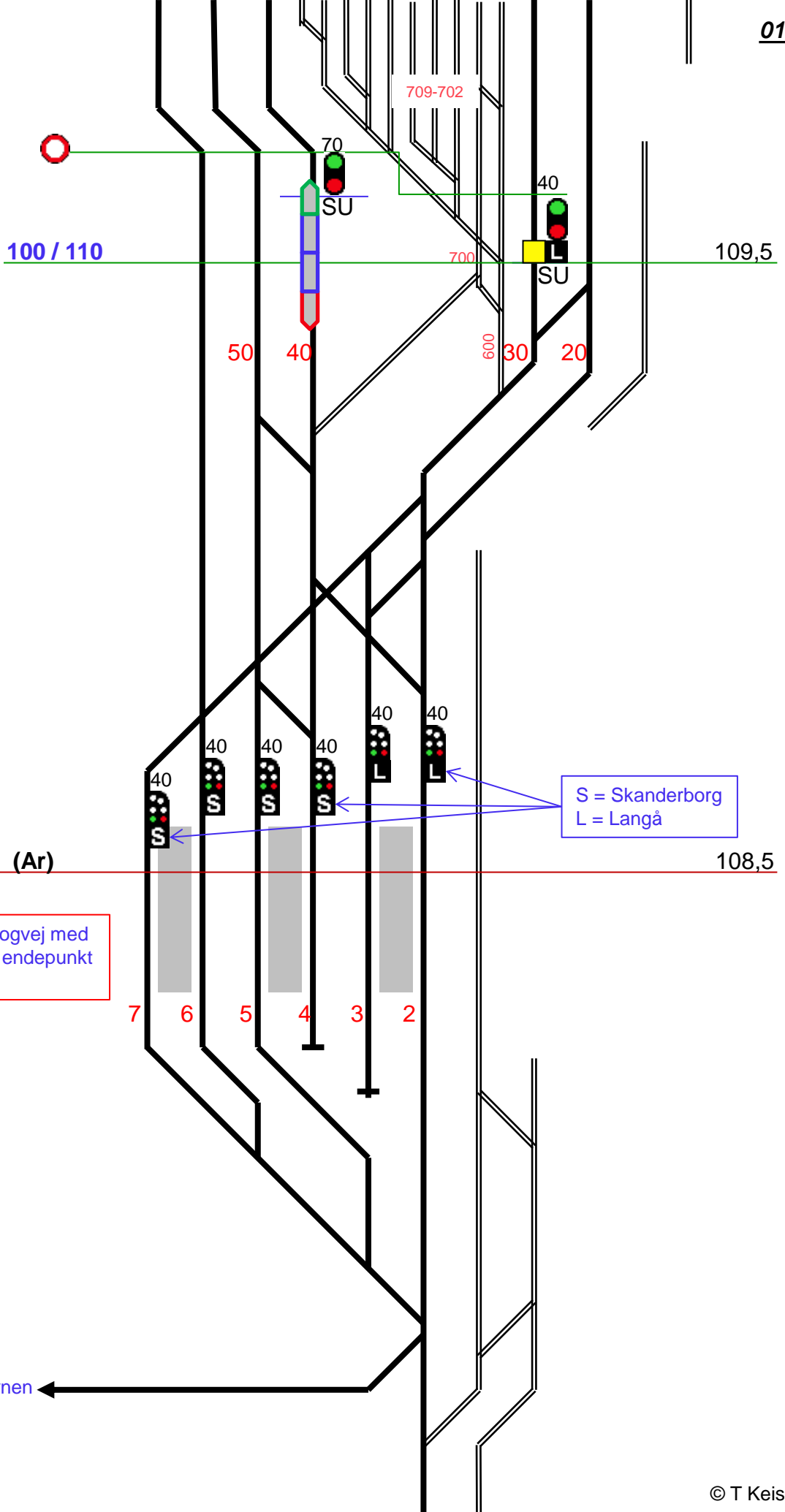

**Aarhus H (Ar)**

Overgangsstation  
ID 64000

Er der stillet en udkørselstogvej med SU-signalet i spor 30 som endepunkt vises **R** i bogstavviseren.

S = Skanderborg  
L = Langå