

Helsingör (Hg)

Övergångsstation
ID 66200

46,2

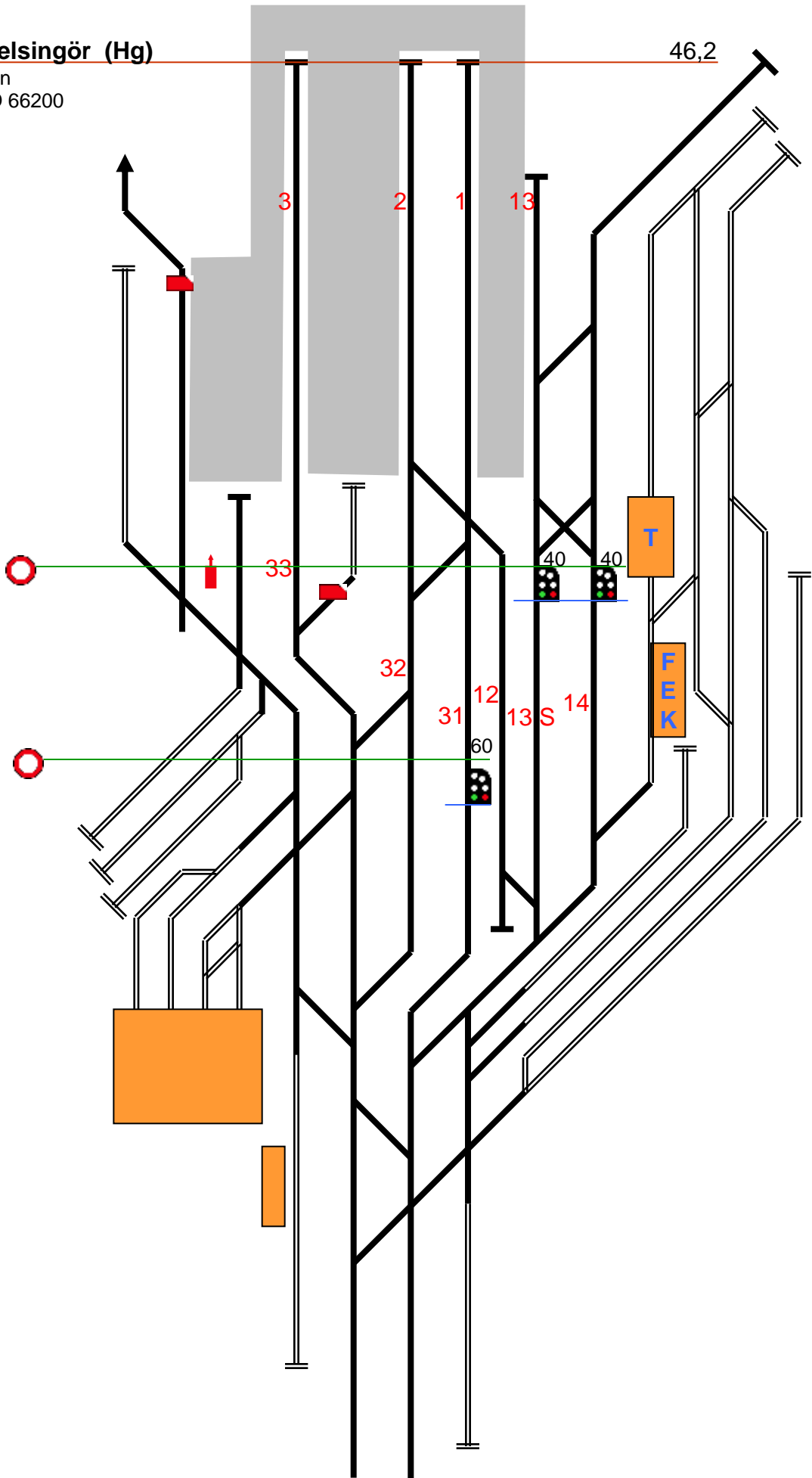

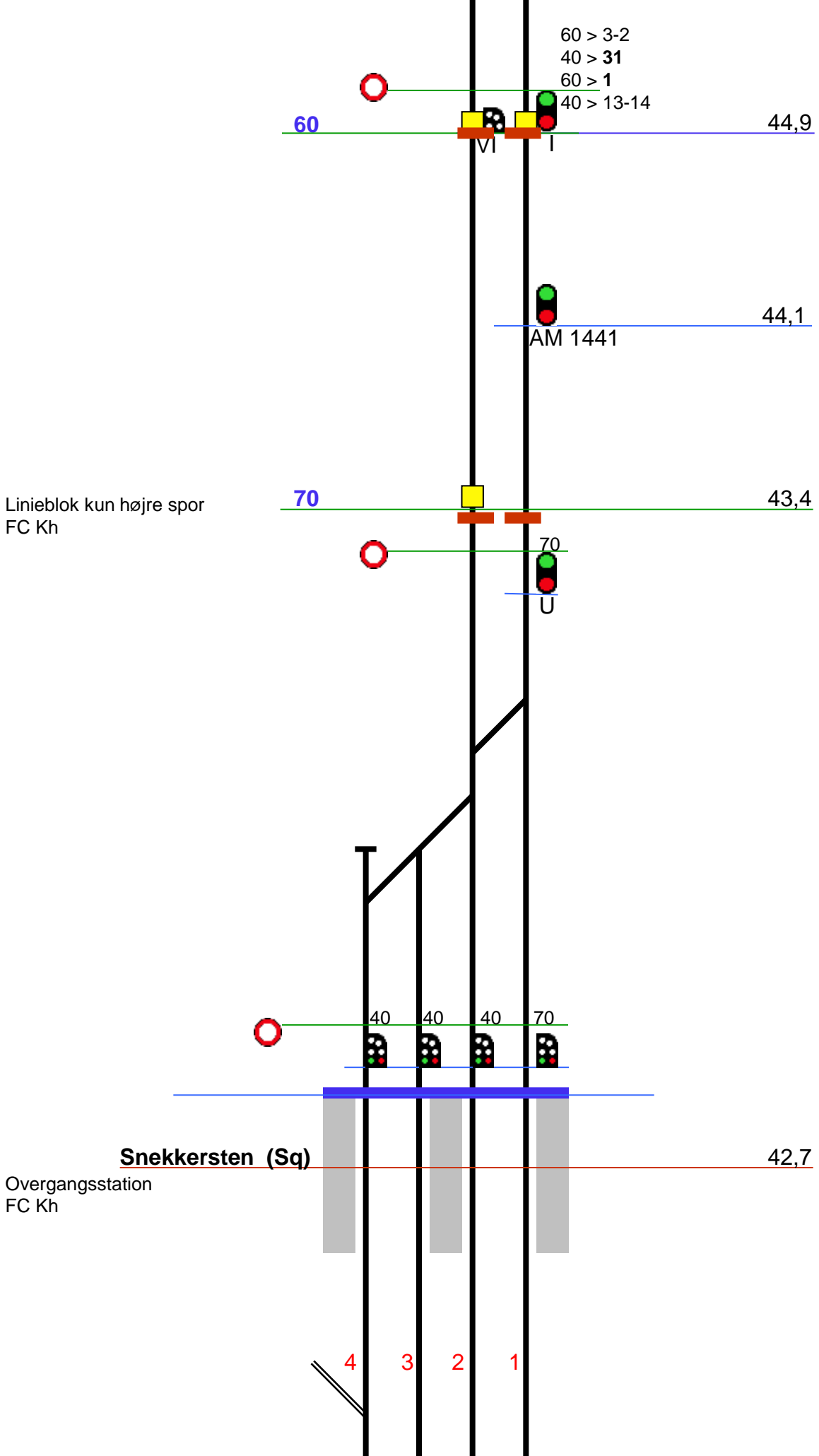

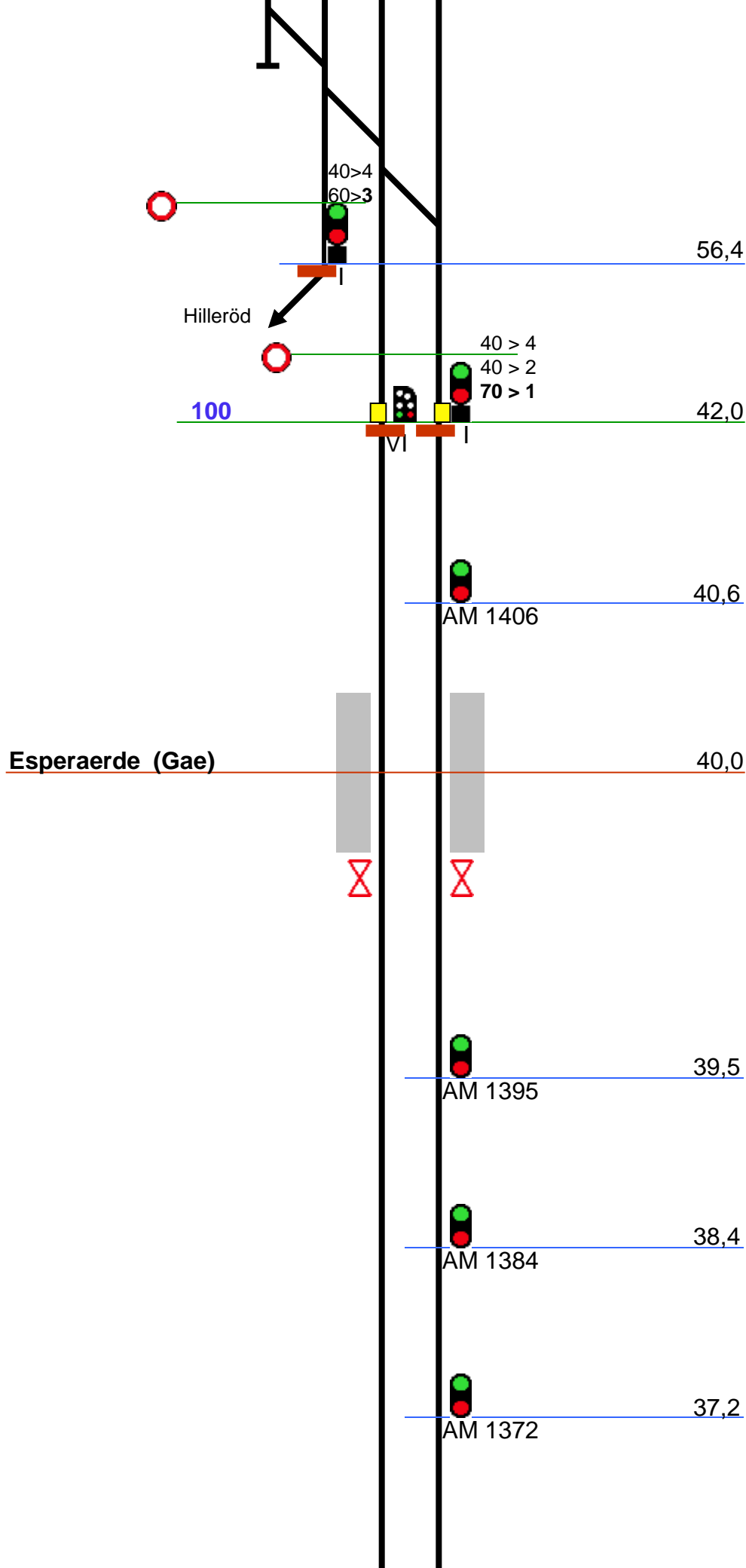

Humblebaek (Hum)

36,3

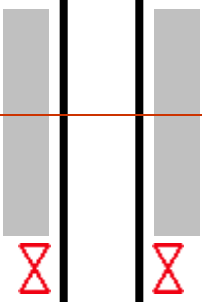

36,0



34,8

Linieblok
FC Kh



33,5



70

70

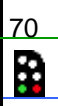
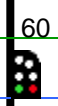

60

70

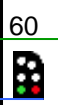

60

Nivå (Ni)

32,5

FC Kh

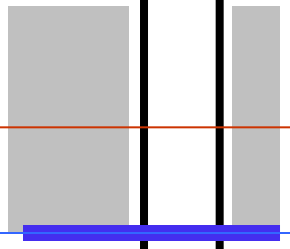

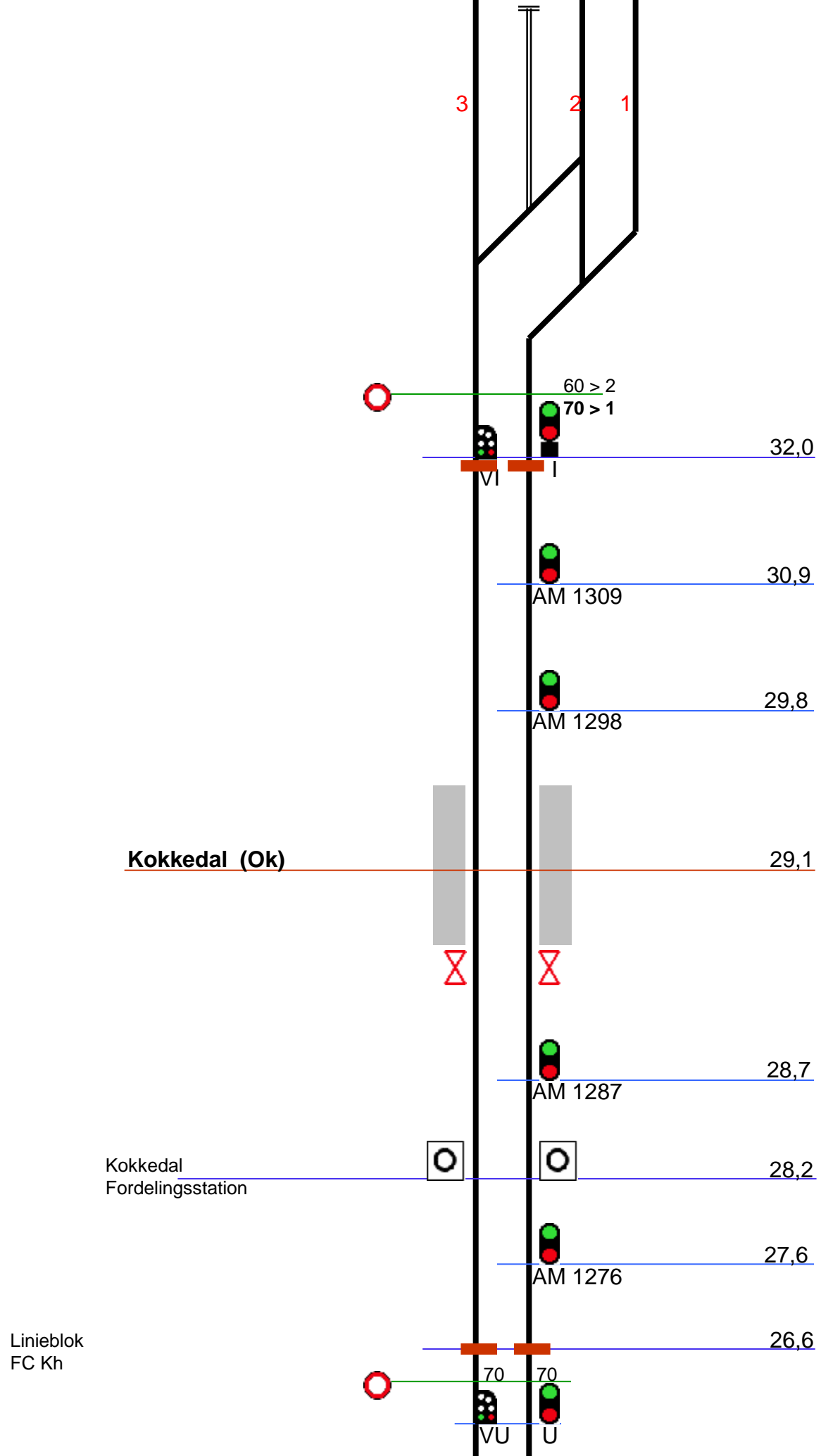

FC Kh

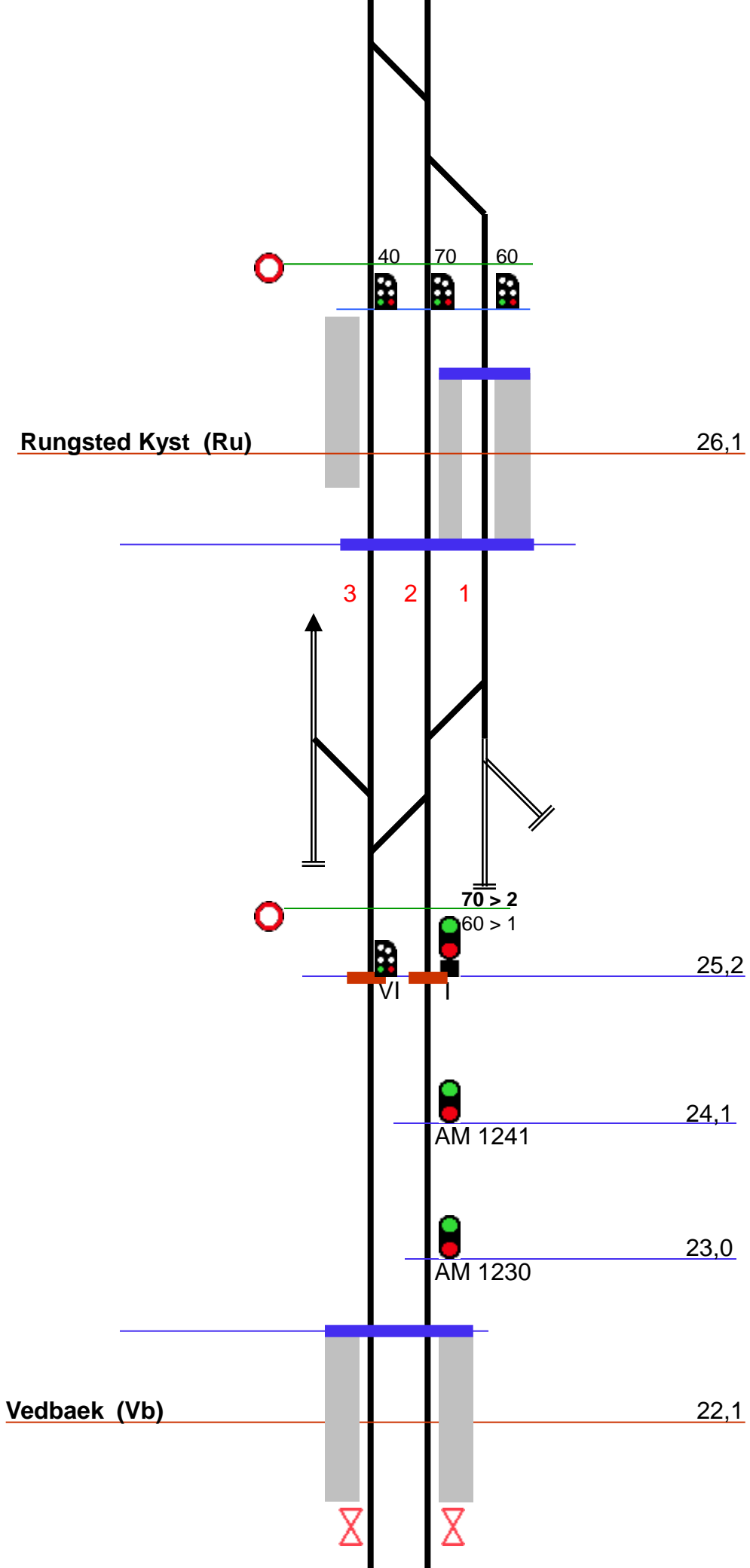

Rungsted Kyst (Ru)

26,1

3 2 1

70 > 2
60 > 1

VI

I

25,2

24,1

AM 1241

23,0

AM 1230

Vedbaek (Vb)

22,1

Linieblok
FC Kh

FC Kh

Skodsborg (Så)

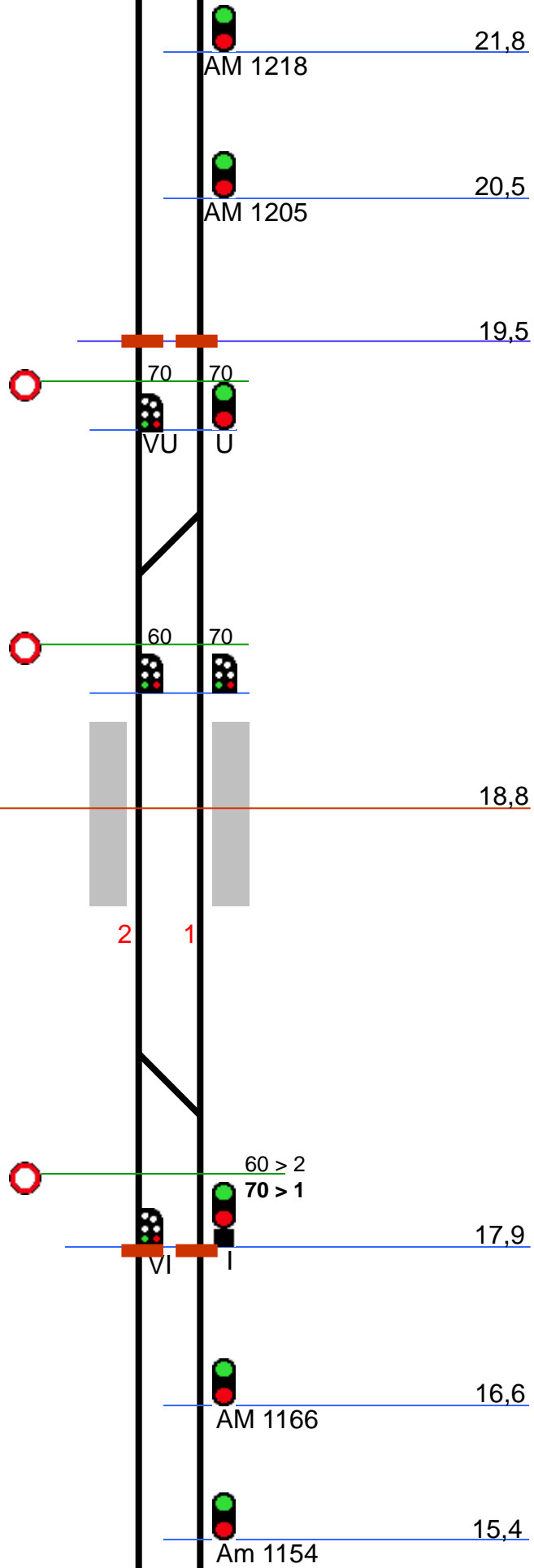

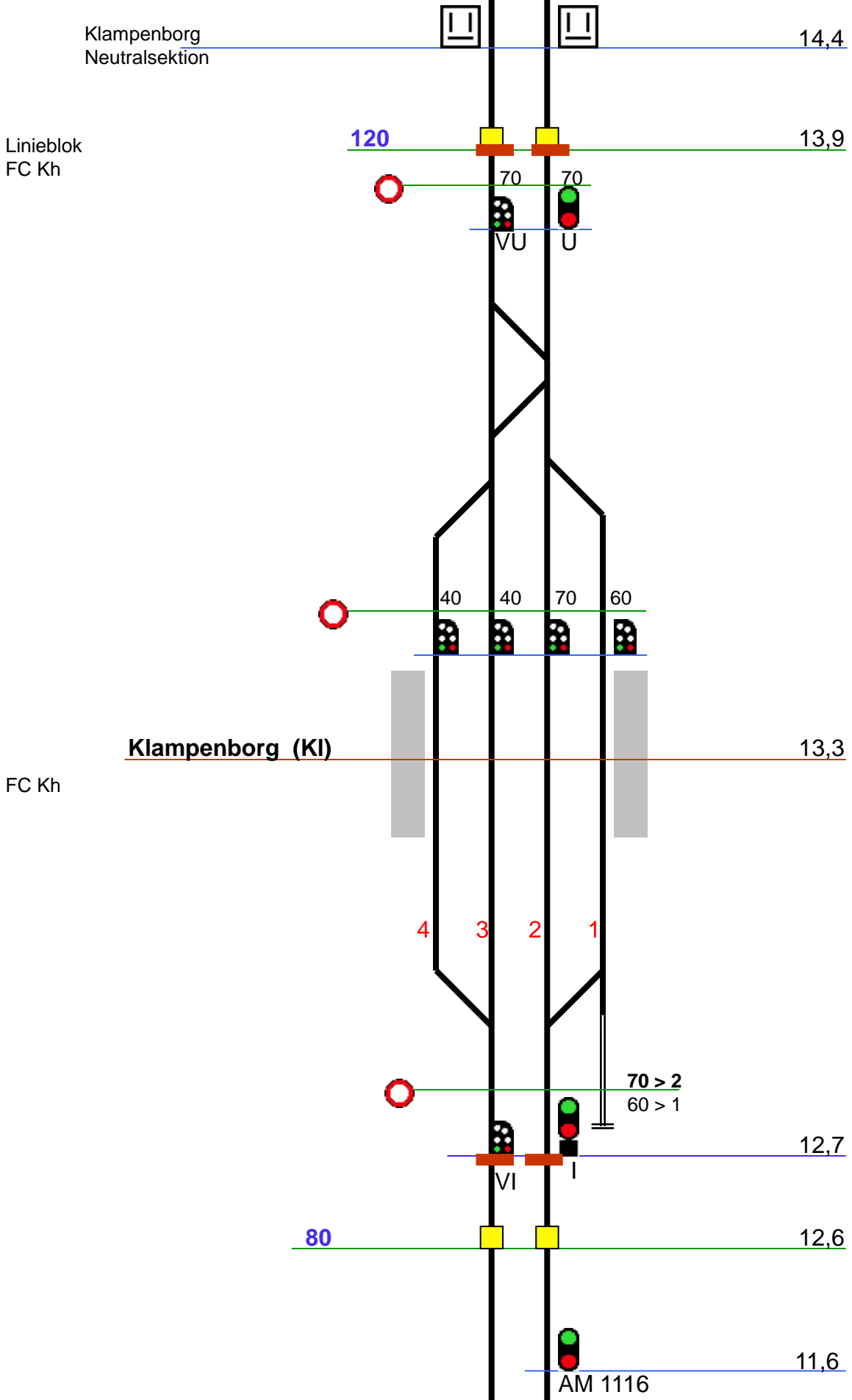

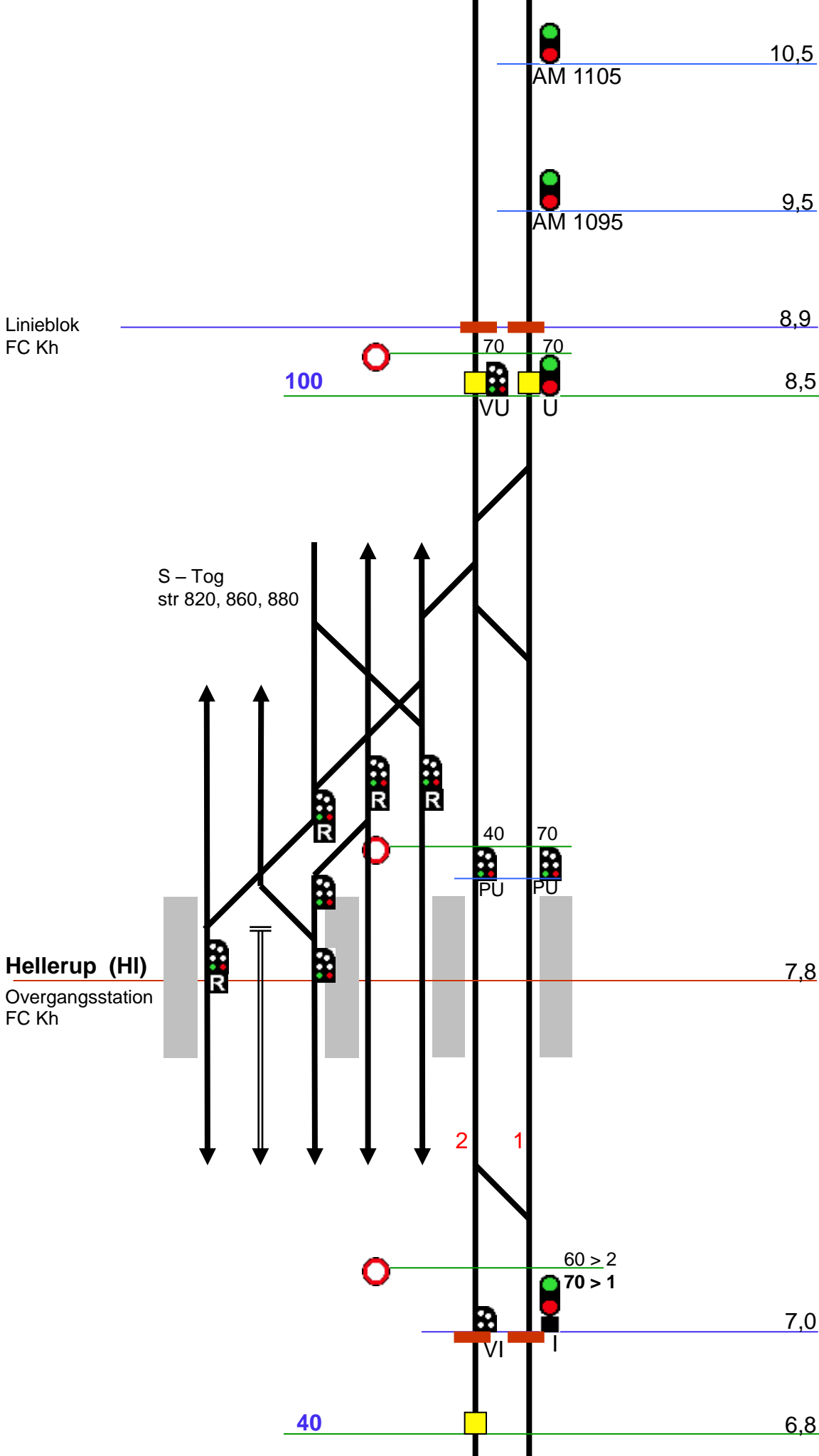

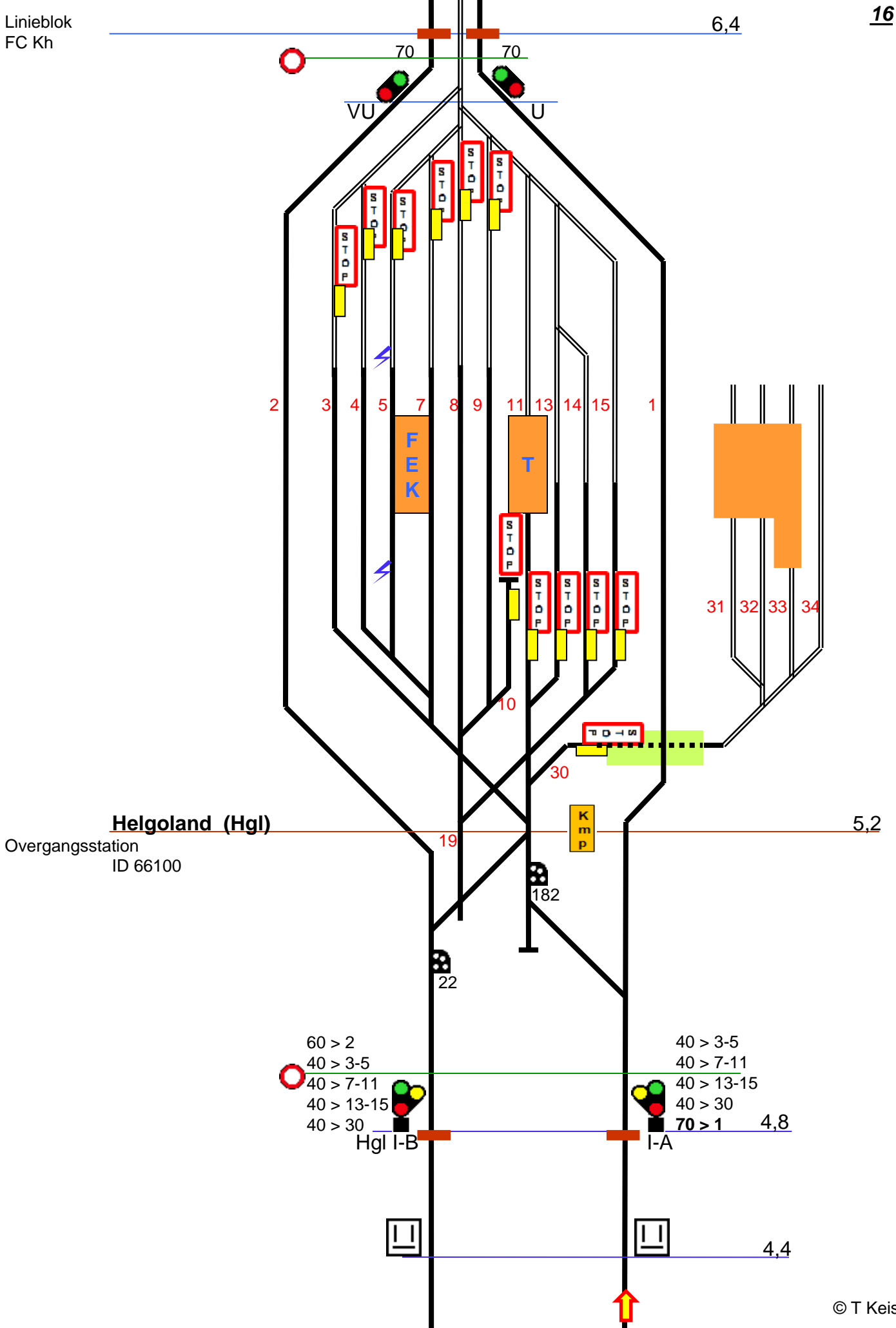

Helgoland (Hgl)

Overgangsstation
ID 66100

5,2

Hgl I-B

I-A

4,4

Linieblok / Vekselspor
FC Kh

Lersøen
strækning 7
3,9

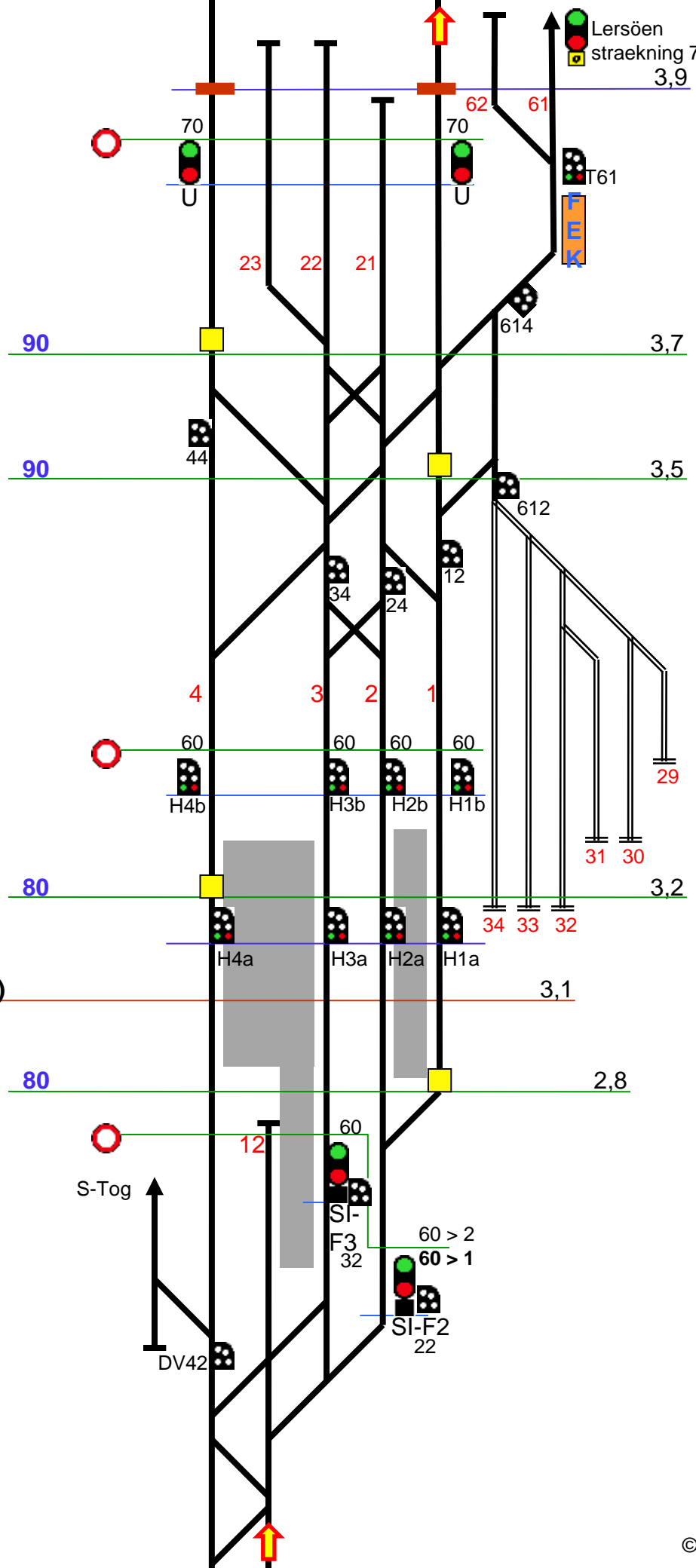

Österport (Kk)
Overgangsstation
FC Kh ID 66000

S-Tog

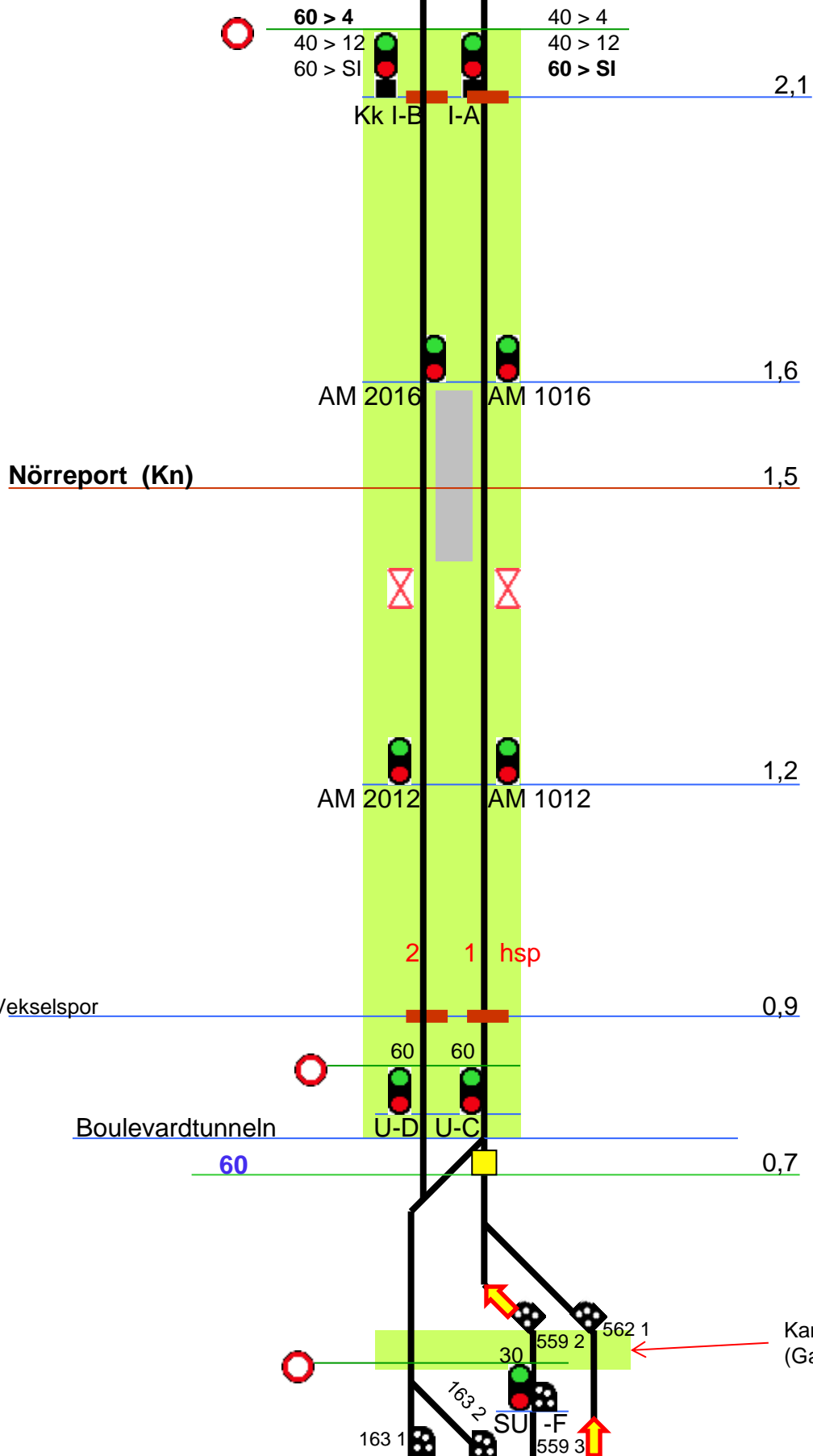

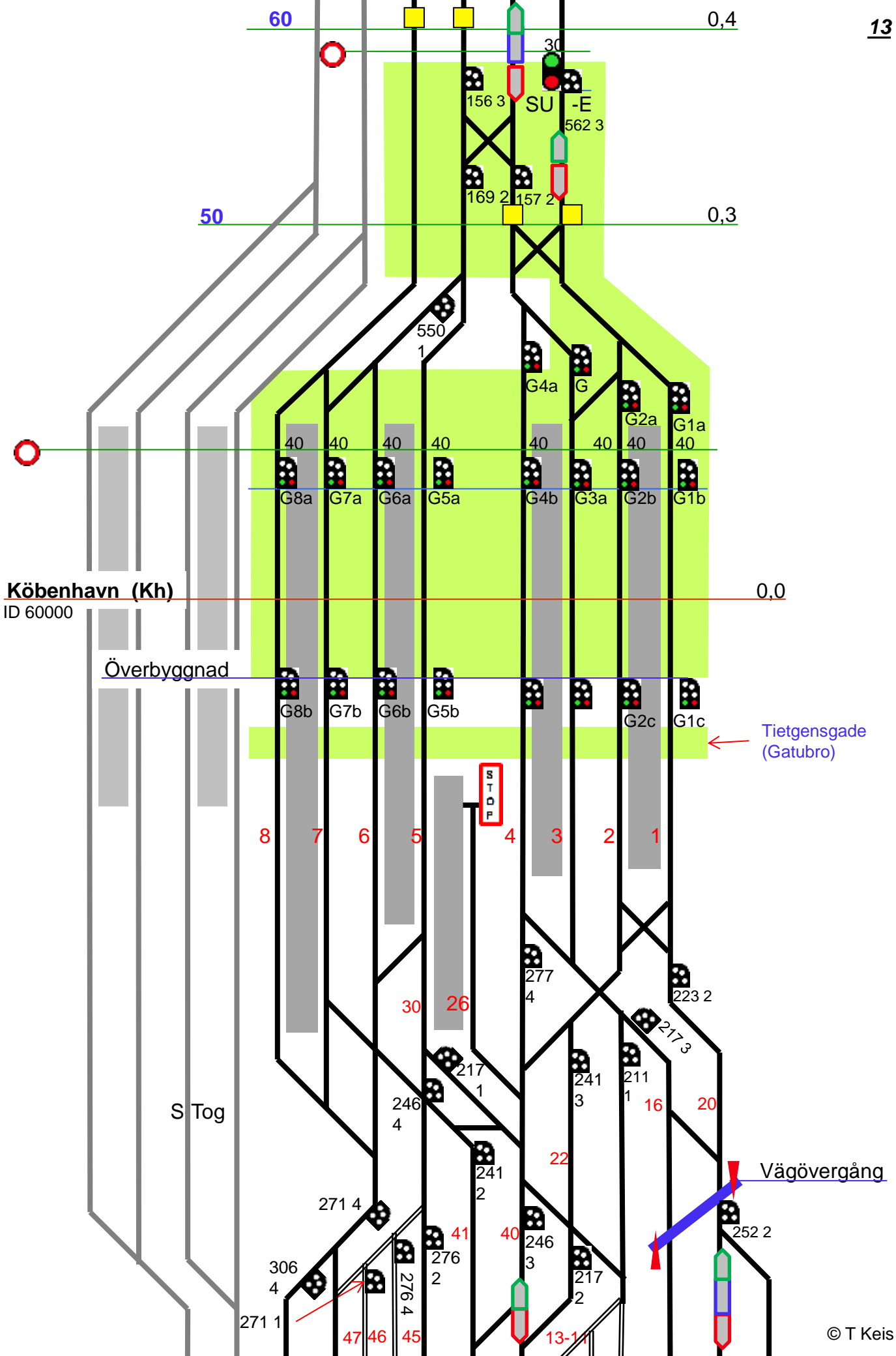

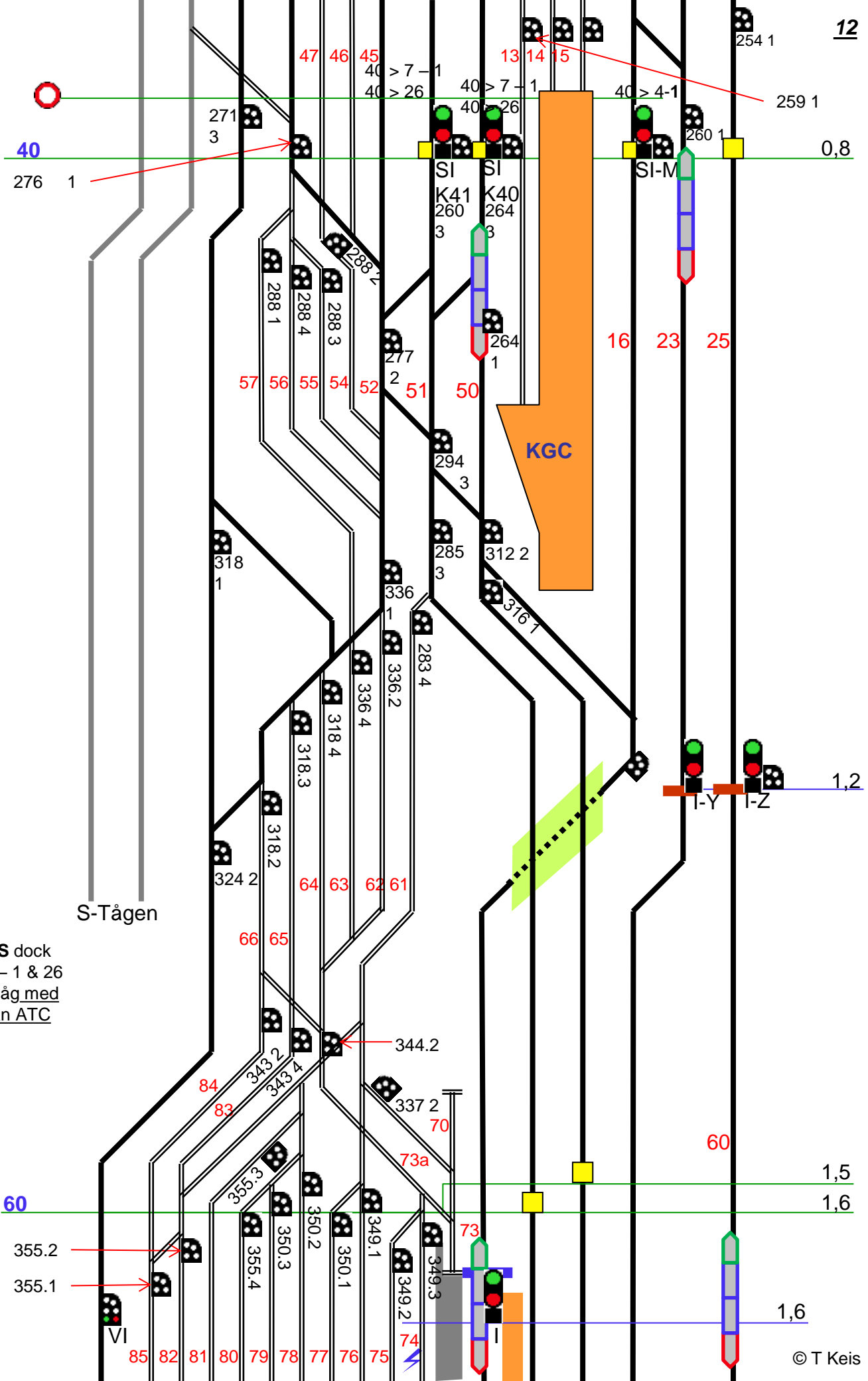

Vid **TUS** dock
 30 > 8 – 1 & 26
 Gäller tåg med
 och utan ATC

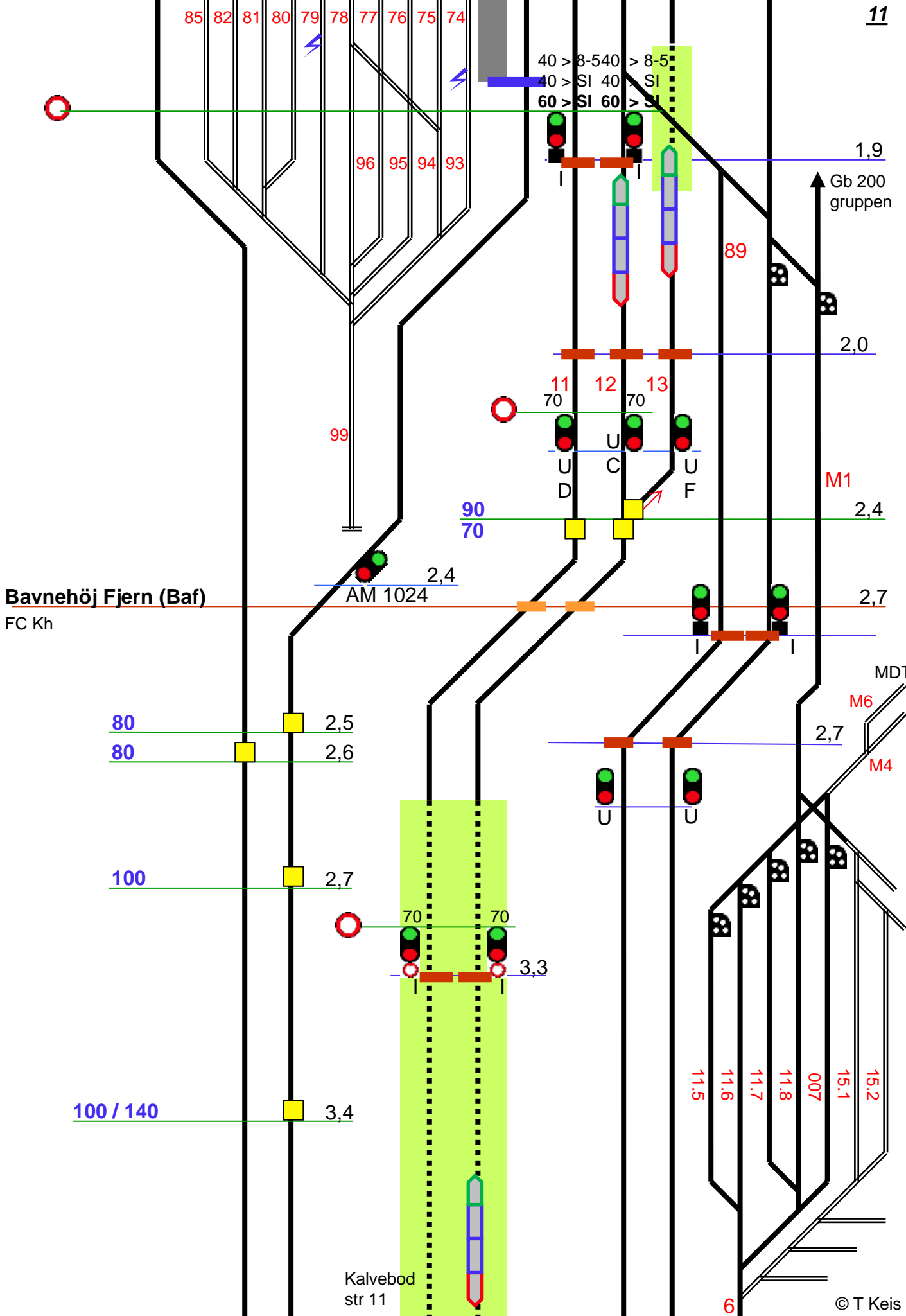

85 82 81 80 79 78 77 76 75 74

40 > 8-540 > 8-5
40 > SI 40 > SI
60 > SI 60 > SI

1,9
Gb 200 gruppen

96 95 94 93

89

2,0

11 12 13
70 70
U D U C U F

M1

90
70

2,4

Bavnehøj Fjern (Baf)
FC Kh

2,4
AM 1024

2,7

80 2,5
80 2,6

MDT
M6
M4

2,7

100 2,7

70 70
3,3

15.2
15.1
007
11.8
11.7
11.6
11.5

100 / 140 3,4

Kalvebod str 11

6

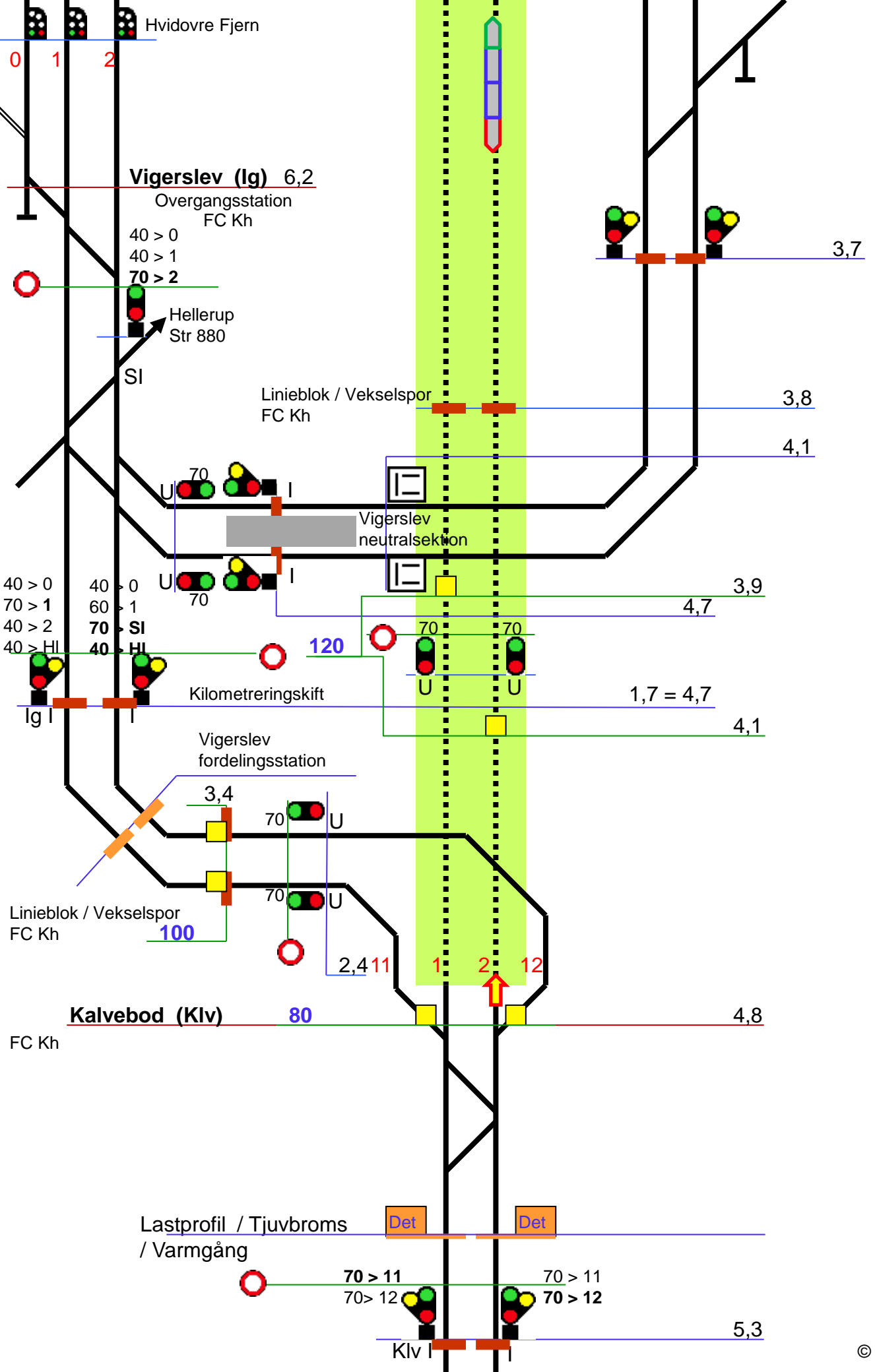

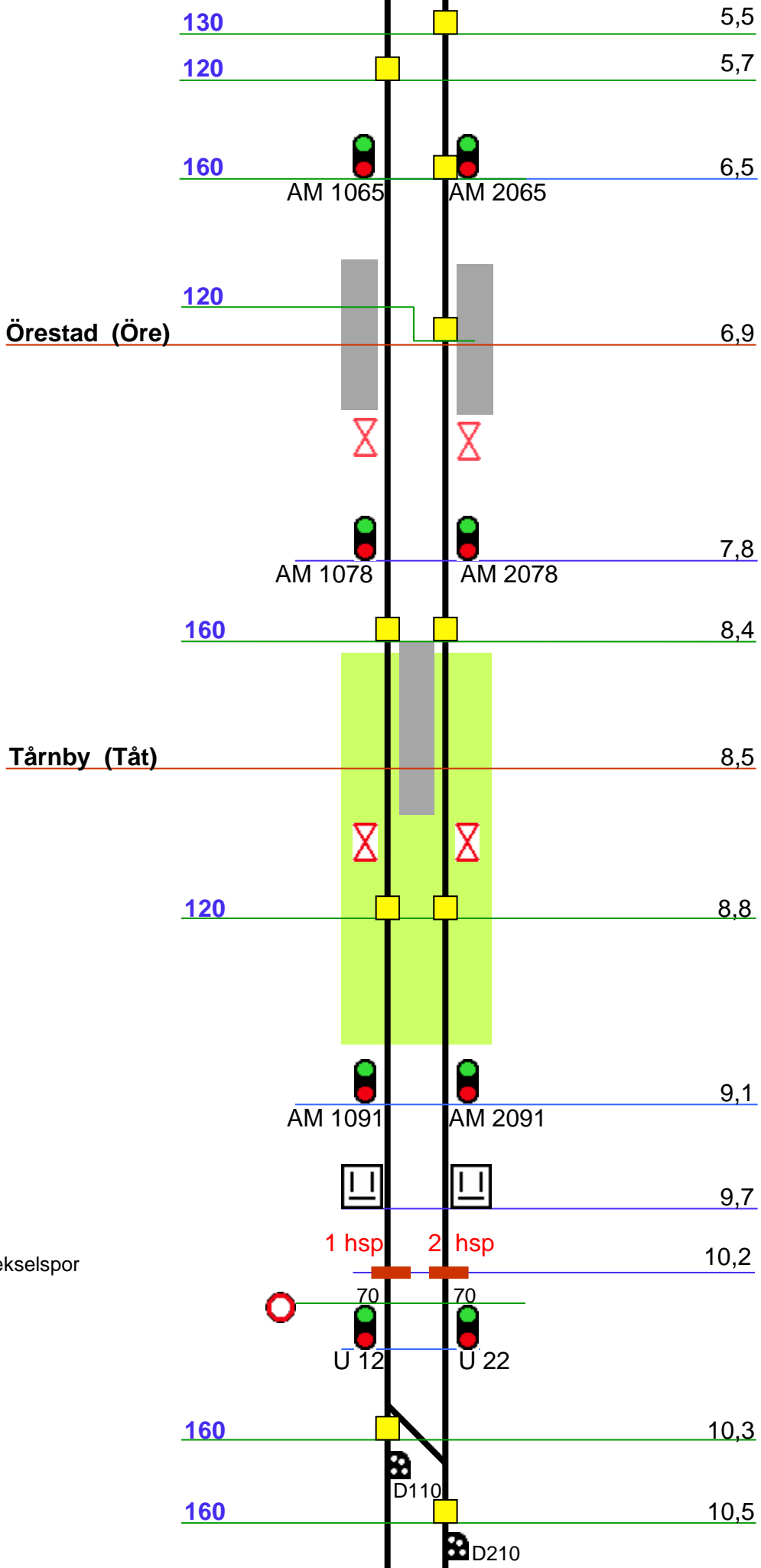

Linieblok / Vekselspor
FC Kh

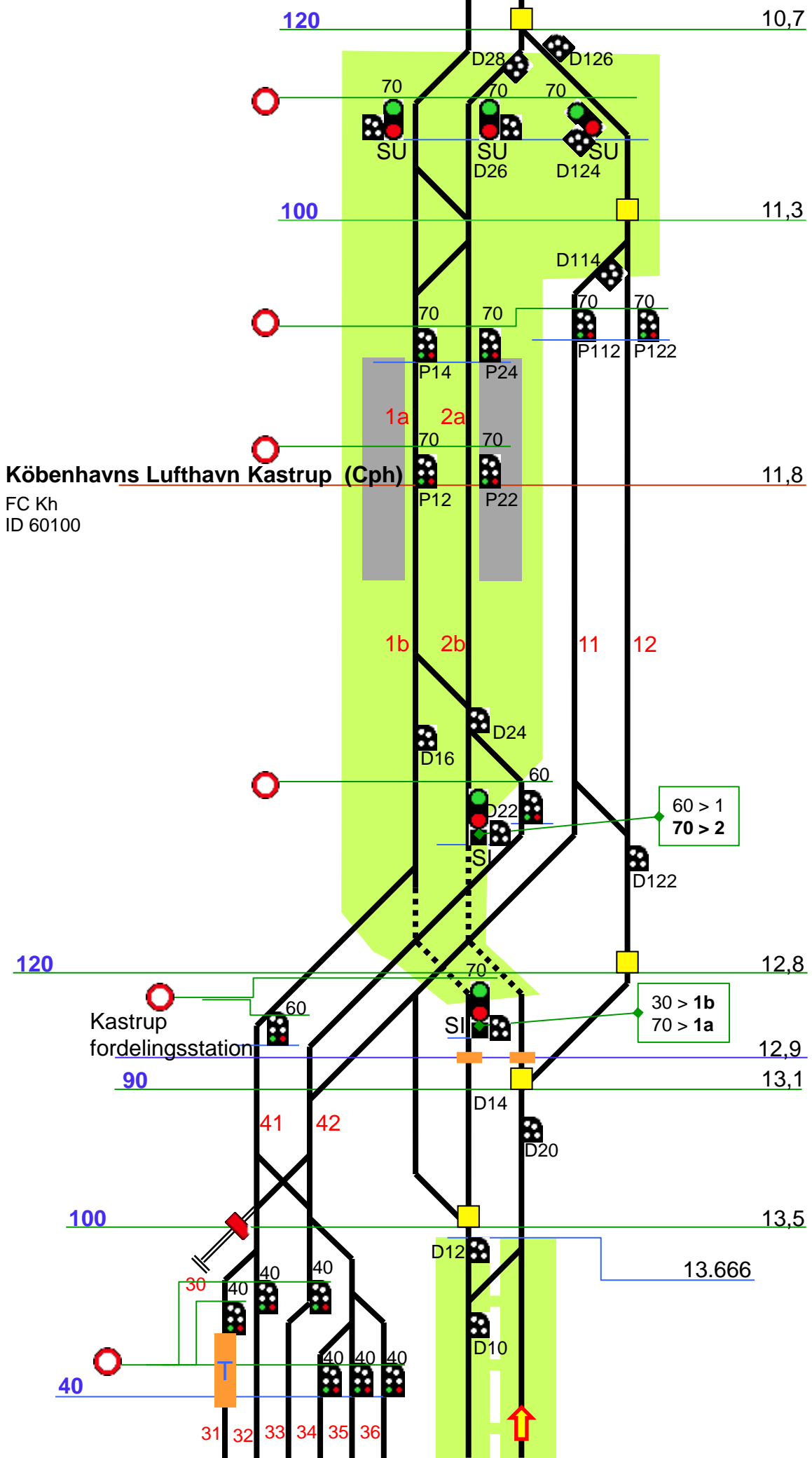

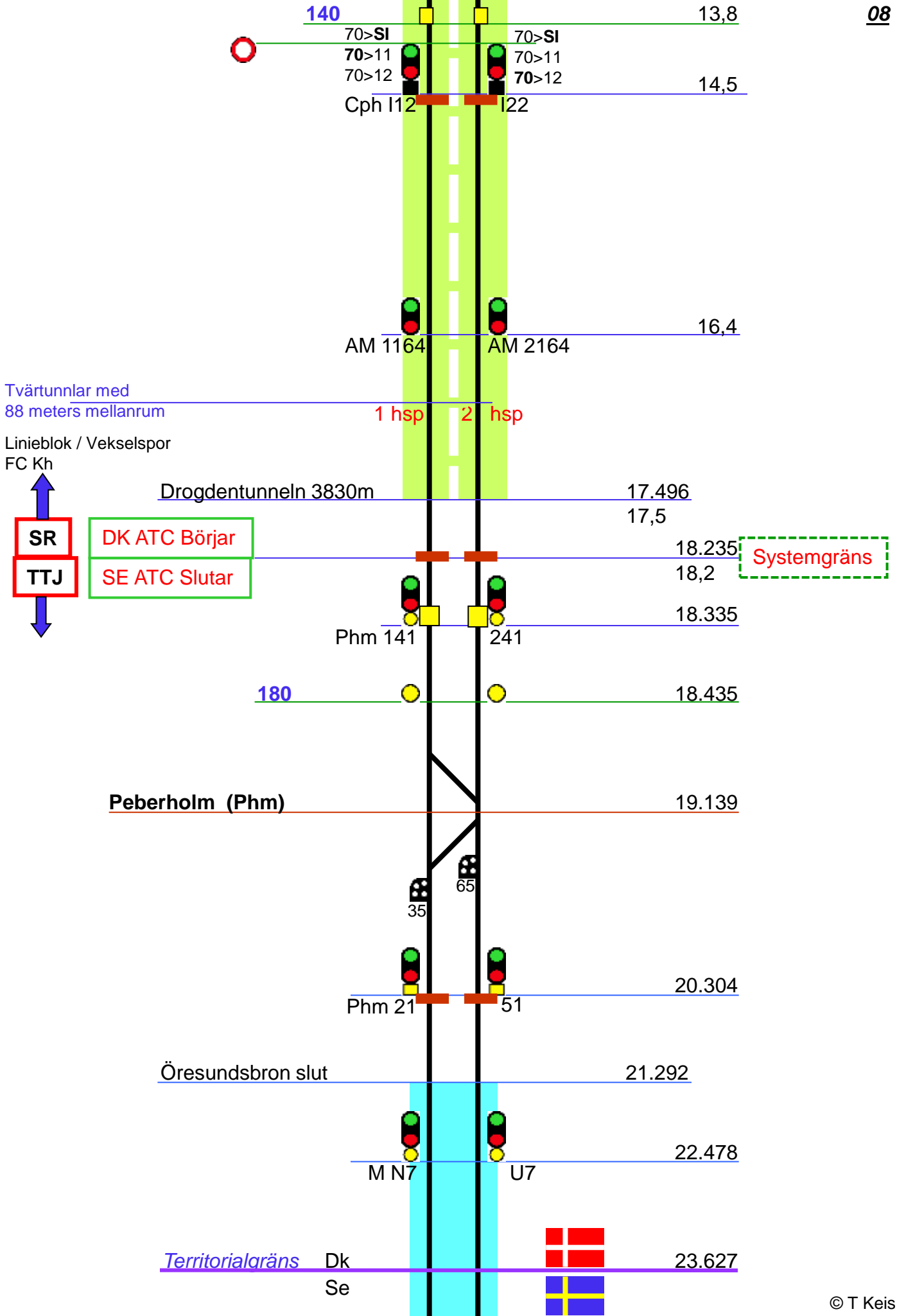

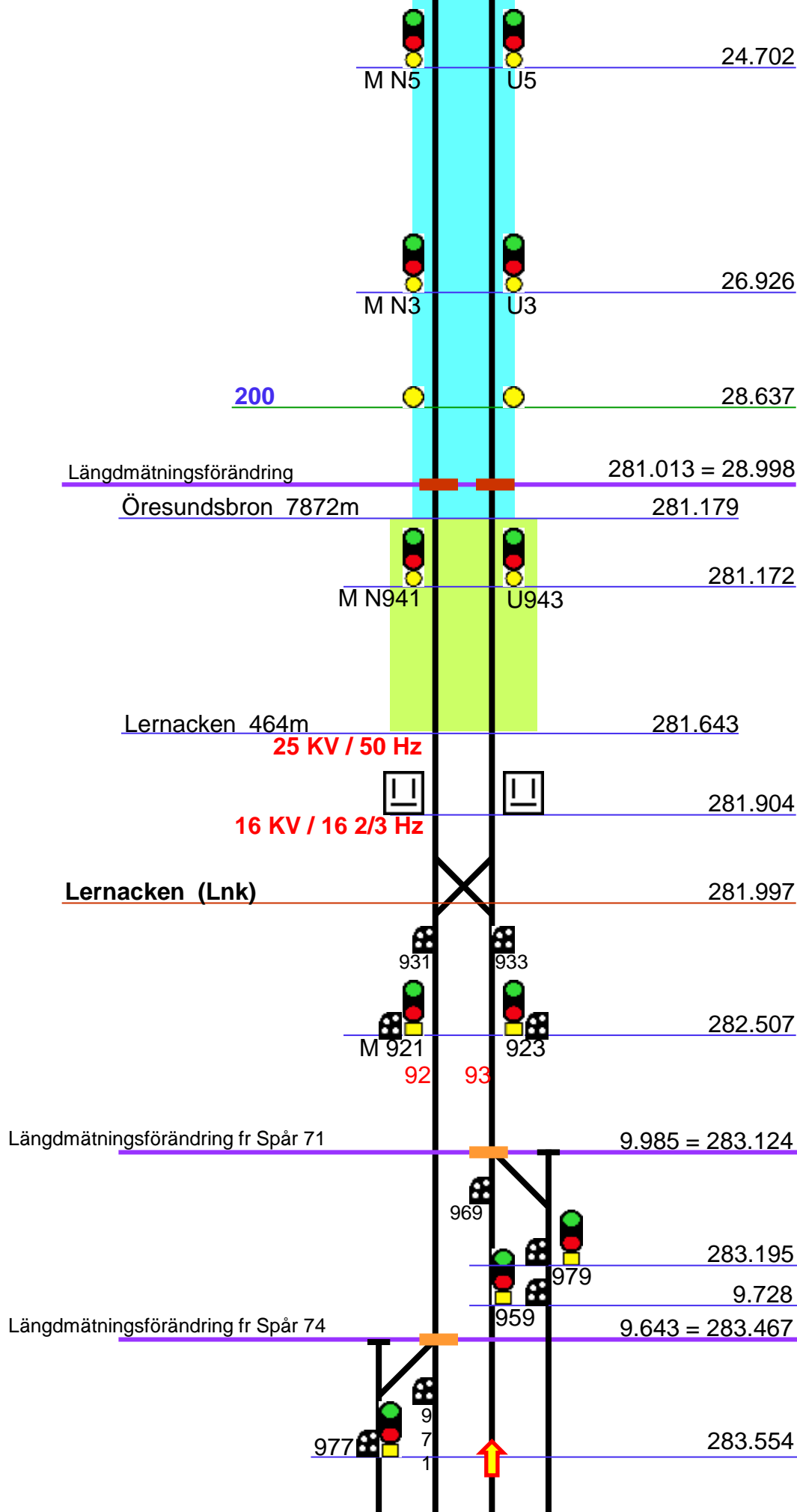

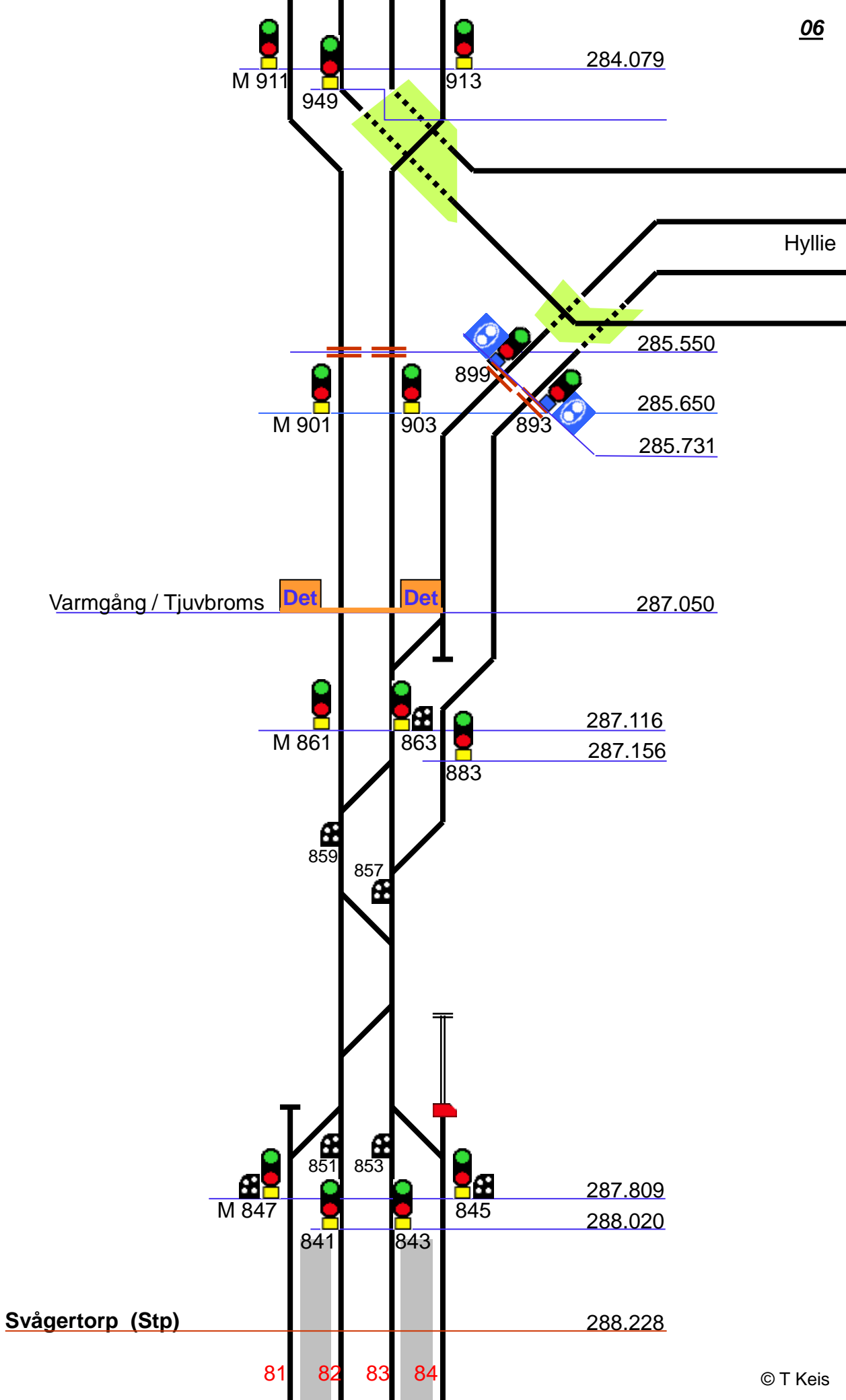

M 911 949 913 284.079

Hyllie

M 901 903 899 893 285.550 285.650 285.731

Varmgång / Tjuvbroms Det Det 287.050

M 861 863 883 287.116 287.156

859 857

M 847 851 853 841 843 845 287.809 288.020

Svågertorp (Stp) 288.228

81 82 83 84

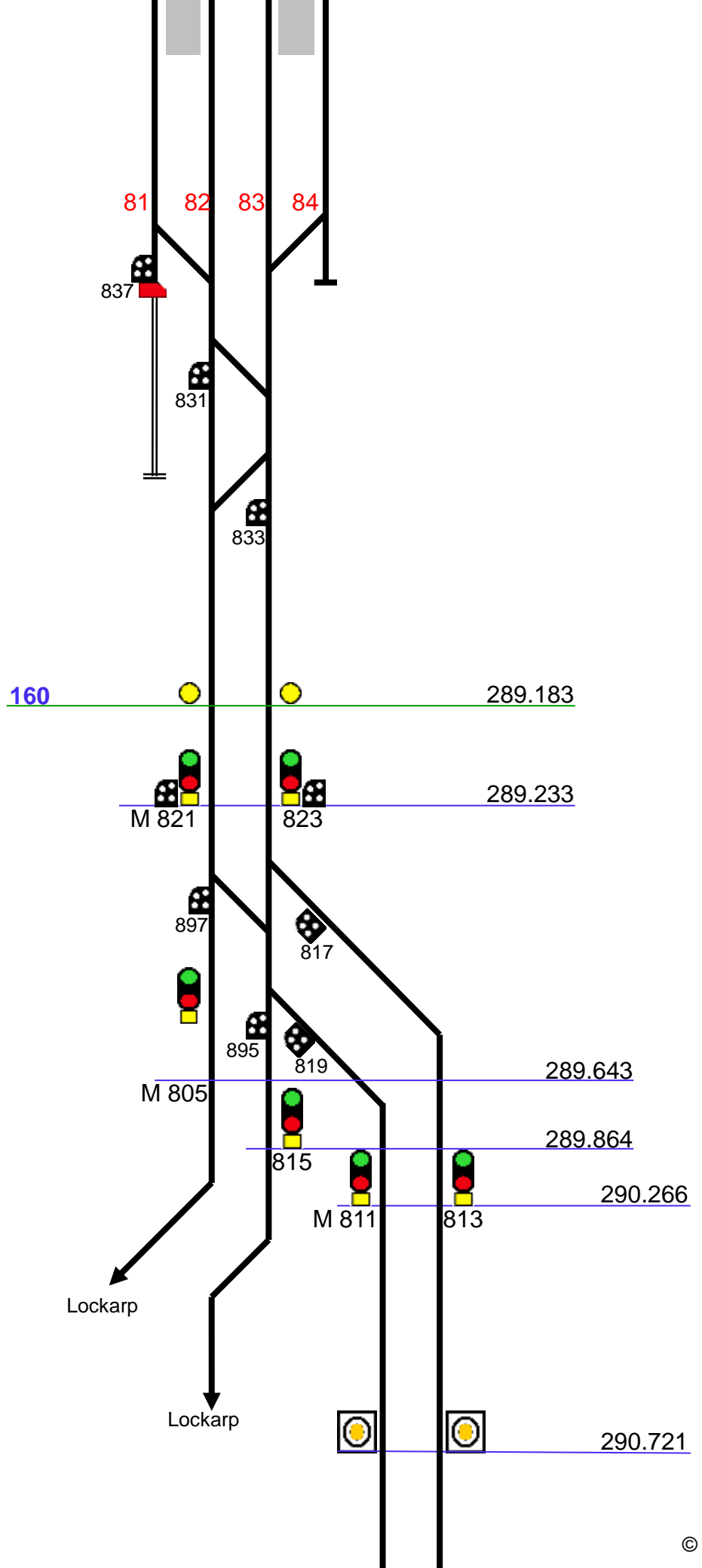

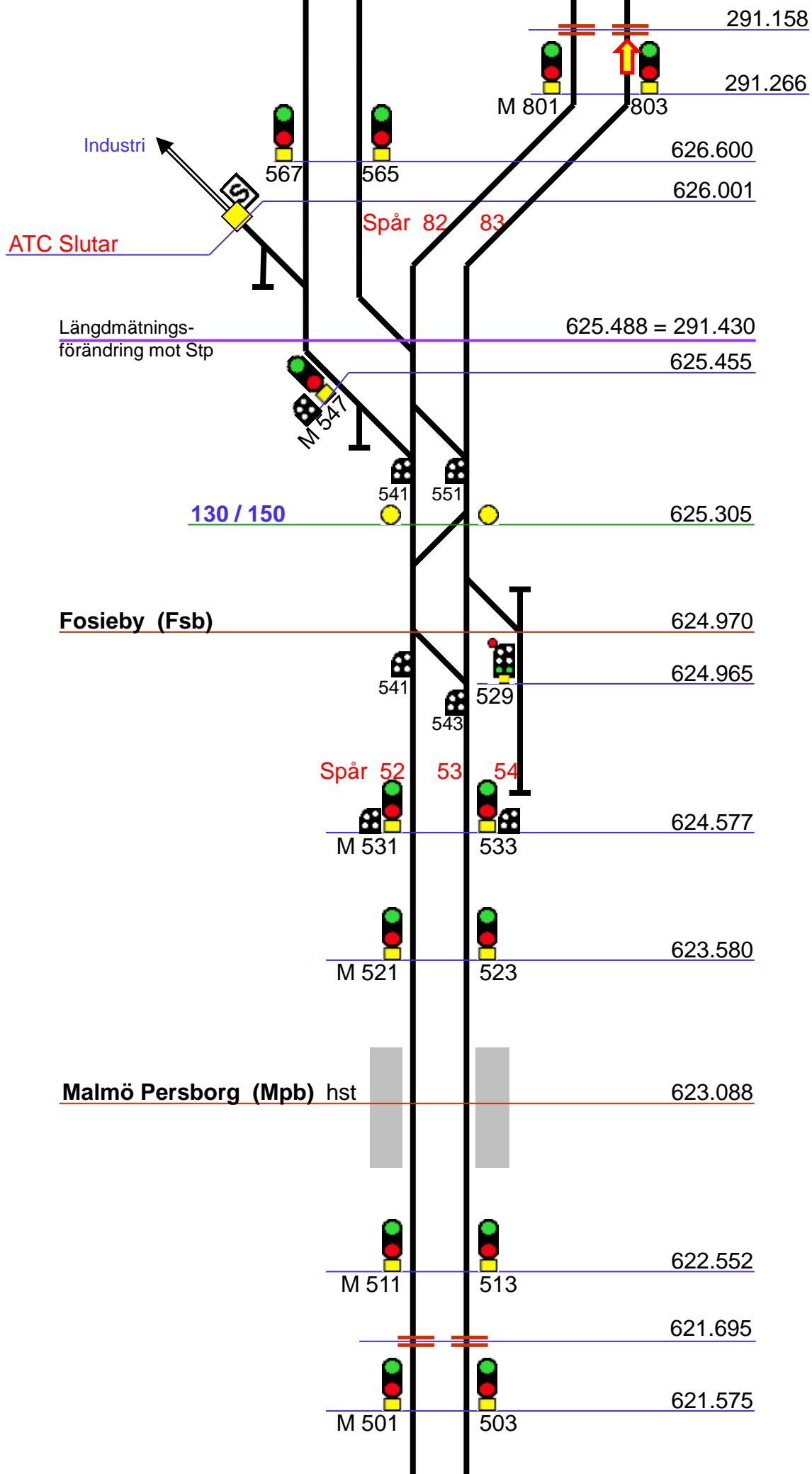

160 / 200

621.155

Svedala

620.799

TGOJ

461

463

465

619.940

445

619.885

M 437

431

443

619.834

Östervärn (Övn)

Spår 41 42 43 44

619.739

90 / 100

Kurva

619.352

Arlöv

413

619.330

Malmö gb

411

618.961

616.724

178

180

176

174

170

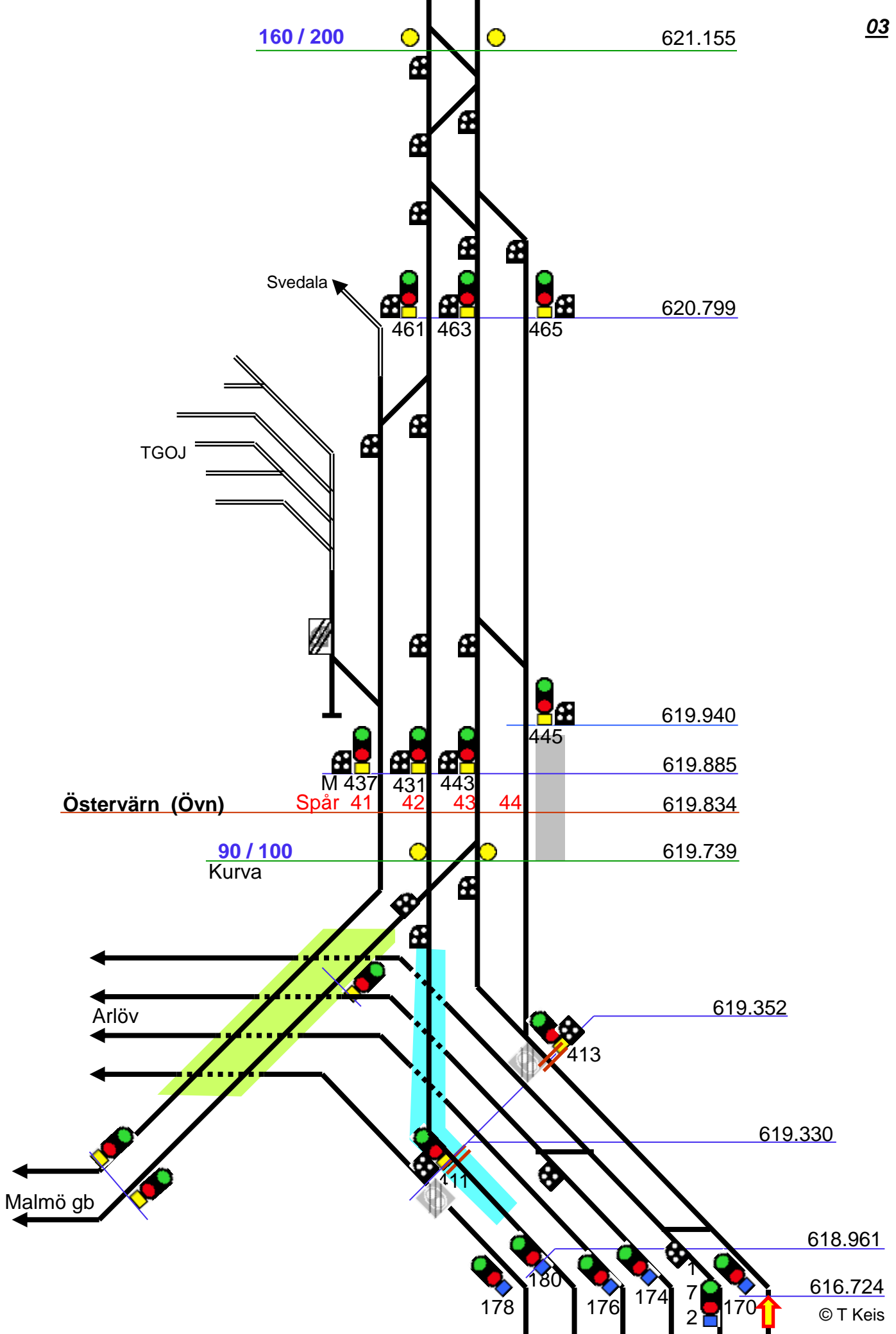

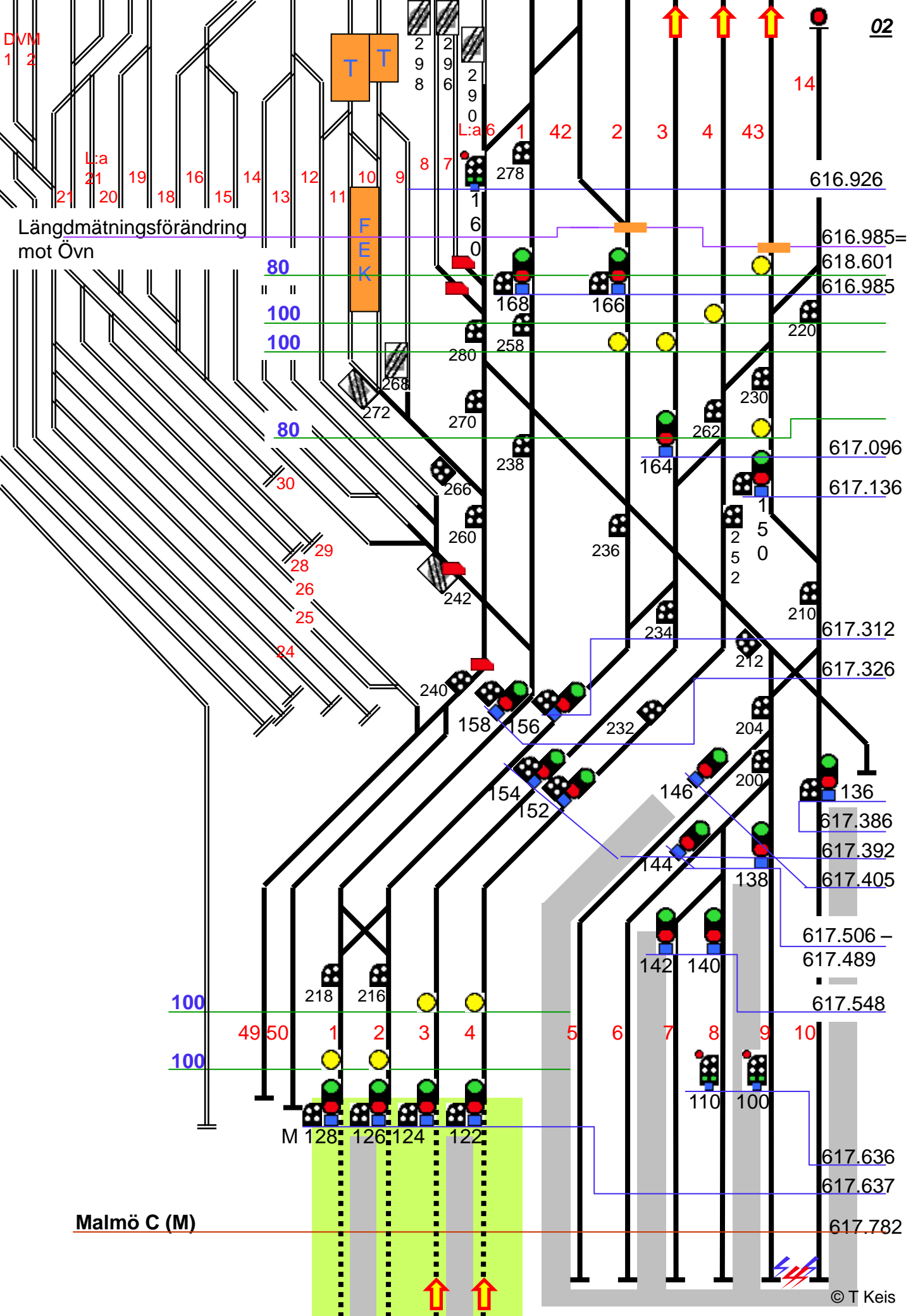

Längdmätningförändring
mot Övn

Malmö C (M)

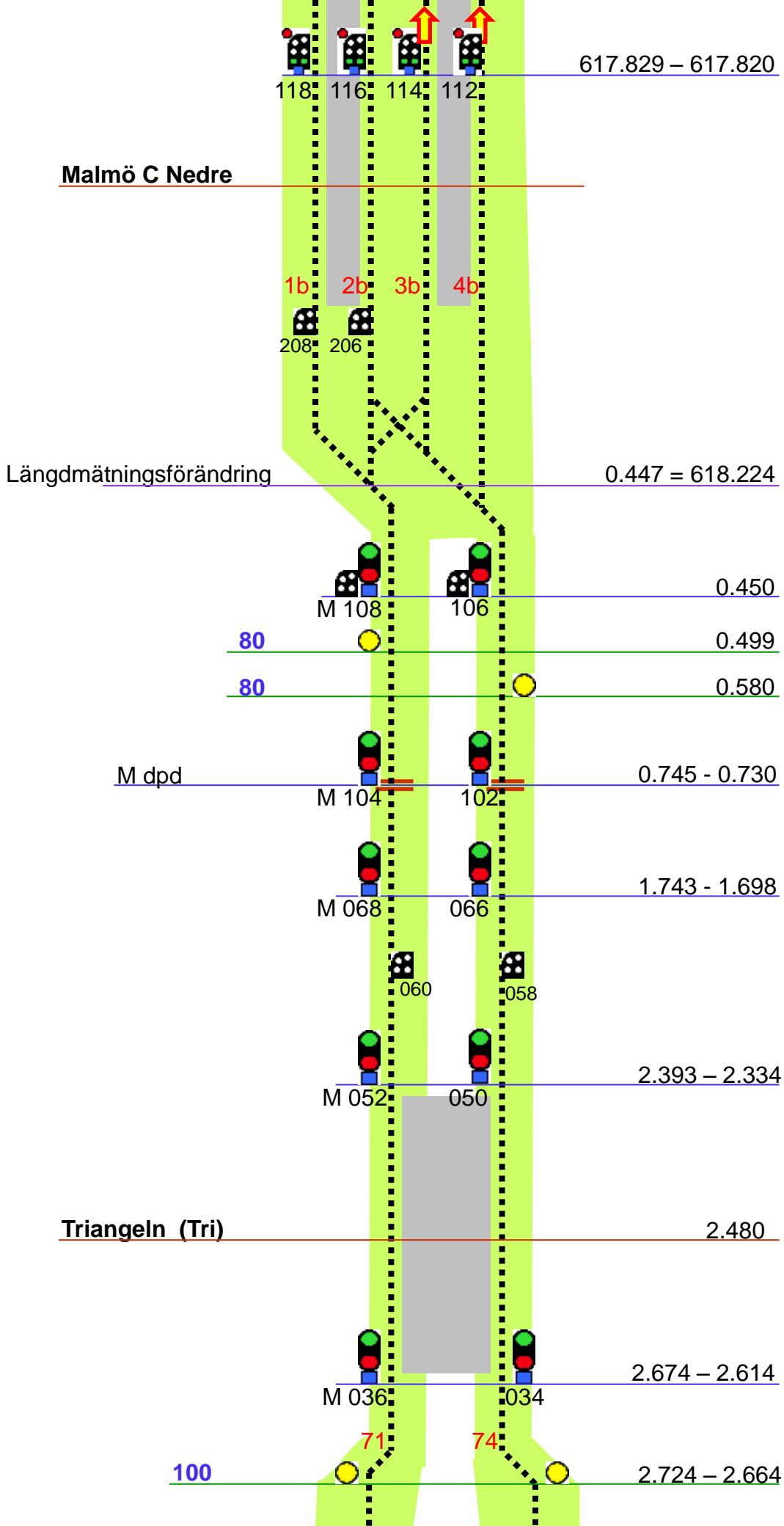

Malmö C Nedre

617.829 – 617.820

118 116 114 112

1b 2b 3b 4b

208 206

Längdmättningsförändring

0.447 = 618.224

M 108 106

0.450

80

0.499

80

0.580

M dpd

M 104 102

0.745 - 0.730

M 068 066

1.743 - 1.698

060 058

M 052 050

2.393 – 2.334

Triangeln (Tri)

2.480

M 036 034

2.674 – 2.614

100

71

74

2.724 – 2.664